

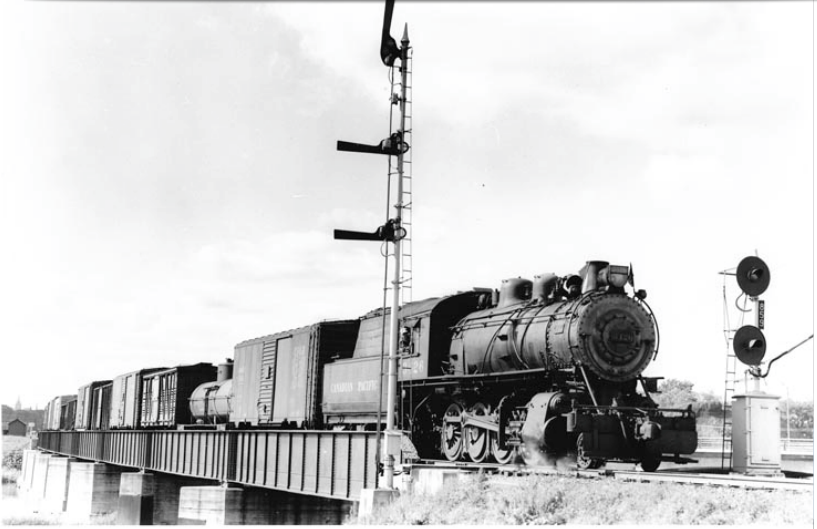

Old Railway Rideau River Pedestrian Bridge Structure No. 018600 Detailed Condition Assessment and Renewal Option Analysis Report

Contract No.
ISD17-7087
Work Order Package
No. 11316522



Old Railway Rideau River Pedestrian Bridge Structure No. 018600

Detailed Condition Assessment and Renewal Options Analysis Report

Prepared for:



Contract No. ISD17-7087
Work Order Package No. 11316522

Prepared by:

PARSONS

November 2018

Parsons Project No. 476506

TABLE OF CONTENTS

EXECUTIVE SUMMARY.....	EX - 1
1. INTRODUCTION.....	1
2. STRUCTURE DESCRIPTION.....	1
3. DATA COLLECTION AND REVIEW.....	3
4. DETAILED CONDITION SURVEY.....	4
4.1 INSPECTION METHODOLOGY.....	4
4.2 STRUCTURE IDENTIFICATION SHEET.....	6
4.3 SUMMARY OF SIGNIFICANT FINDINGS.....	7
4.3.1 Asphalt Wearing Surface and Waterproofing.....	7
4.3.2 Timber Deck.....	7
4.3.3 Timber Curbs.....	7
4.3.4 Expansion Joints.....	7
4.3.5 Deck Drainage System.....	8
4.3.6 Bridge Railing System.....	8
4.3.7 Approach Barriers.....	8
4.3.8 Structural Steel.....	8
4.3.9 Structural Steel Coating System.....	9
4.3.10 Bearings.....	9
4.3.11 Abutments.....	10
4.3.12 Piers.....	10
4.3.13 Embankments and Slope Protection.....	11
4.3.14 Waterway.....	11
4.3.15 Retaining Walls.....	11
4.4 FIELD INVESTIGATION AND LABORATORY TESTING.....	11
4.4.1 Abutments.....	11
4.4.2 Piers.....	12
4.4.3 Structural Steel Coating System.....	13
5. RENEWAL OPTIONS ANALYSIS.....	14
5.1 RENEWAL OPTIONS.....	17
5.2 ENVIRONMENTAL PERMIT AND APPROVAL REQUIREMENTS.....	20
5.3 CONSTRUCTION STAGING AND TRAFFIC MANAGEMENT.....	21
5.4 CONSTRUCTION DURATION.....	21
5.5 FINANCIAL ANALYSIS.....	22
6. RECOMMENDATIONS.....	23
7. CLOSURE.....	24

LIST OF FIGURES

Figure 1 – Key Plan	2
---------------------------	---

LIST OF TABLES

Table 1: Lead, Mercury and Arsenic Concentrations in the Structural Steel Coating System.....	13
Table 2: Summary of Financial Life Cycle Cost Analysis	22

APPENDICES

APPENDIX A.	OSIM INSPECTION FORMS
APPENDIX B.	SELECTED INSPECTION PHOTOGRAPHS
APPENDIX C.	UNDERWATER INSPECTION MEMO (ODS MARINE)
APPENDIX D.	DETERIORATION DRAWINGS
APPENDIX E.	SUBSTRUCTURE CONDITION SURVEY MATERIAL SAMPLING AND TESTING RESULTS (GEMTEC)
APPENDIX F.	STRUCTURAL STEEL COATING ANALYSIS RESULTS
APPENDIX G.	STAKEHOLDER CORRESPONDENCES
APPENDIX H.	FINANCIAL ANALYSIS DATA AND DCA FORMS
APPENDIX I.	PRELIMINARY GENERAL ARRANGEMENT DRAWING

EXECUTIVE SUMMARY

The Old Railway Rideau River Pedestrian Bridge (SN018600), built in 1898, is an 8-span 160.1 m long riveted steel half deck plate girder (HDPG) structure located just south of Highway 417 (Queensway) and east of the University of Ottawa's Lees Campus. The bridge carried a single railway track on the former CP Rail Montreal & Ottawa Subdivision until its abandonment in 1966 as part of the implementation of the Federal District Commission (now National Capital Commission) *Plan for the National Capital* (also known as Gréber Plan, 1950). The Old Railway Rideau River Pedestrian Bridge has since been re-purposed to carry only pedestrian and cycling traffic. This multi-use crossing of the Rideau River provides an important transportation link between the National Capital Commission's (NCC) Rideau River Eastern Pathway and the City of Ottawa's (City) Rideau River Western Pathway (crossing below the westernmost span) just southeast of Downtown Ottawa.

Parsons, in collaboration with GEMTEC Consulting Engineers and Scientists Ltd (GEMTEC), and ODS Marine, was retained by the City of Ottawa (City) in October 2017 to undertake a detailed condition assessment and renewal options analysis of the structure. Based on the results of the detailed condition assessment, the structure is in overall "poor" condition with several components showing significant signs of deterioration and several components are exhibiting localized areas of deterioration, requiring replacement or rehabilitation in the near future:

- The asphalt wearing surface is exhibiting localized areas of deterioration throughout due to light to severe isolated unsealed transverse cracks, light to severe progressive edge cracks, break-up and potholes at the expansion joints, and light raveling with localized areas of medium to severe raveling in the area between the girder and exterior face of the timber curbs.
- The timber curbs have localized severe to very severe impact damage at all both ends of the timber curbs, likely due to snow plows, light to medium localized checks and splits in all curb faces, and light to severe longitudinal splits throughout the top face of curb.
- The expansion joints are suspected to be leaking throughout due to the level of deterioration noted on the components below the joints, though observed material defects include a broken compression seal at Pier 2 and the seals at the west abutment and Pier 4 are visibly sagging beneath the deck.
- The deck drainage openings (i.e. not deck drains) at 160 locations along the bridge have a significant performance defect as they do not have any downspouts and terminate just below the timber deck soffit, resulting in deck runoff draining directly onto the structural components below the drainage openings, which is directly exposing the structural steel below deck to deck drainage, including salt-laden runoff as the pathway over the structure is maintained during winter months.
- The structural steel below deck exhibits medium to severe corrosion with rust jacking on the girder bottom flanges, medium to very severe corrosion on the horizontal shelf angles, light to medium corrosion on the interior web of the girders, light to very severe corrosion on the vertical stiffeners, severe to very severe corrosion and perforations in multiple locations at each cross-frame (including vertical gusset plates), a section of severe deformation on a top brace of a cross-frame west of Pier 5, severe to very severe corrosion on the rivet heads at all steel member connections, numerous locations of severe to very severe corrosion and perforations on the lateral braces, horizontal gusset plates and/or rivets with multiple cases of complete detachment of the diagonal members from the horizontal gusset plates, light to medium corrosion typical on the diagonal members, and deformation of the bottom flange at the west end of the south girder of Span 7 just above Pier 7.
- The structural steel above deck exhibits localized defects, including a cracked and deformed cover plate due to impact damage to the west end of the south girder, light to medium corrosion on the girder web and knee braces (i.e. vertical gusset plates) in contact with the asphalt wearing surface, and light to medium corrosion with rust jacking on the interior top flange between cover plates.
- The structural steel coating system has been in service for 49 years, long since exceeding its expected service life, and exhibits widespread deterioration on all below-deck structural steel components, including severe surface rust, undercutting and peeling, resulting in light to very severe corrosion

present on all steel members. The exterior and above-deck structural steel coating system exhibits localized areas of peeling underneath the exterior top flange of the girders, severe surface rust on the top and bottom girder flanges, exterior web of girders, and at the asphalt/girder interface on the interior web of girders.

- The steel spherical disc plate and plate bearings exhibit extensive coating deterioration, resulting in light to severe corrosion on bearing surfaces, and significant debris on the interior of the bearings, which is suspected to be impeding bearing movement. The southeast bearing on Pier 7 has a cracked steel casing temporarily repaired with a clamping device and a nut is not tightened down on this fixed bearing anchor bolt. The anchor bolt at the northwest expansion bearing at Pier 4 has sheared off.
- The east abutment wall, bearing seat and exposed footing exhibit numerous severe to very severe delaminations, spalls and extensive disintegration up to 150 mm deep with exposed corroded reinforcing steel, and have concrete considered of poor quality.
- The west abutment wall and bearing seat exhibit localized areas of severe to very severe disintegration at the top of the abutment wall and bearing seat at the north end, wet efflorescence stained hairline pattern cracking on the bearing seat and light popouts on the wall.
- The ballast walls exhibit significant deterioration on both ends of the walls due to severe to very severe spalls, delaminations and disintegration up to 150 mm deep with exposed corroded rebar, wet and efflorescence stained hairline to narrow map cracking, medium and wide vertical and horizontal cracks on the east ballast wall, and medium honeycombing and wet staining in the west ballast wall.
- The wingwalls exhibit deteriorated areas mainly at the west ballast wall and top of wingwalls, including light to very severe disintegration up to 150 mm deep, spalls and delaminations with exposed corroded rebar, wet and efflorescence stained hairline to narrow map cracking, medium to wide horizontal crack on the southwest wingwall, and medium scaling and medium honeycombing along a horizontal construction joint on the northwest wingwall.
- The piers exhibit extensive deterioration, including severe to very severe disintegration with exposed corroded reinforcing steel and delaminations on and below the bearing seats of Piers 1, 3 and 5 to 7, and on all surfaces of Pier 4. Localized defects on the pier shafts and footings include light to very severe disintegration, spalls and delaminations, hairline to wide horizontal and vertical cracks (including horizontal construction joints) and map cracking with and without efflorescence, light to very severe scaling, rust staining due to corroding rebars, and extensive wet and efflorescence staining.
- The approach railing system has localized severe to very severe corrosion (with up to 75% section loss) at the base of the railing posts embedded into the top of the concrete wingwalls.
- The east embankment in front of the abutment has lost of material due to erosion.

One (1) rehabilitation option and one (1) replacement option were developed for the renewal of the Old Railway Rideau River Pedestrian Bridge, taking into account the findings of the Detailed Condition Assessment of the structure and correspondences with stakeholders.

Based on the results of the renewal options analysis (including a life cycle cost analysis), it is recommended that it is recommended that **Option 2 – Structure Replacement in 2023** be selected as the preferred renewal strategy for the structure. However, based on the existing condition of the structure (i.e. mainly the structural steel bracing below deck), if capital funding is available earlier, it is recommended that the structure replacement be started earlier so that the replacement bridge is completed, and the existing bridge taken out of service by the end of the 1 to 5-year timeframe (i.e. 2019 – 2023). The construction cost for the recommended renewal option (Option 2) is **\$9,86M** (in 2018 dollars), including a 25% contingency allowance and 20% for engineering costs, engineering services during construction and construction administration services, but excluding HST.

It is recommended that the structure replacement be completed on a new alignment upstream of the existing bridge, which would allow pedestrians and cyclists to continue using the existing structure without significant disruption until the new bridge is constructed and placed in service, and the existing bridge is then demolished.

The construction is expected to be completed in 52 to 60 weeks, depending on contractor capabilities, scheduling and selected sequencing of the work, and work force provided.

Although the approach railing replacement was included in the scope of work and costing for each renewal option in 2023 for simplicity of evaluating the renewal options, this work should be completed in 2019, as the extensive deterioration of the railing posts poses a potential safety concern for pedestrians.

The following maintenance work is also recommended to be completed:

- Rout and seal cracks and patch any potholes in bridge deck asphalt wearing surface
- Install bollard on the east approach
- Replace damaged timber curbs at ends of bridge
- Remove graffiti on the abutments, piers and on the exterior of the north girder at the west abutment
- Clean debris on abutment and pier bearing seats

1. INTRODUCTION

The Old Railway Rideau River Pedestrian Bridge (SN018600) is located just south of Highway 417 (Queensway) and east of the University of Ottawa's Lees Campus (Photo 1). This multi-use crossing of the Rideau River provides an important transportation link between the National Capital Commission's (NCC) Rideau River Eastern Pathway and the City of Ottawa's (City) Rideau River Western Pathway (crossing below the westernmost span) just southeast of Downtown Ottawa (Photo 2). The location of the bridge is shown on the key plan below (Figure 1).

Parsons, in collaboration with GEMTEC Consulting Engineers and Scientists Ltd (GEMTEC), and ODS Marine, was retained by the City of Ottawa (City) in October 2017 to undertake a detailed condition assessment and renewal options analysis of the structure. The scope of work included the following:

- Collecting and reviewing all available data;
- Carrying out a detailed visual inspection (Enhanced OSIM inspection) in accordance with the MTO Ontario Structure Inspection Manual (OSIM) and the City's 2017 Supplementary Clarifications;
- Carrying out a Level 1 underwater inspection in accordance with the MTO Ontario Structure Inspection Manual (OSIM);
- Undertaking a detailed substructure condition survey, including material sampling and testing, in accordance with the procedures prescribed in the MTO Structural Rehabilitation Manual (SRM);
- Carry out a coating investigation in accordance with the MTO Structural Steel Coating Manual (SSCM), including coating type identification and designated substances concentration determination;
- Developing and evaluating up to three (3) feasible renewal options, including preparing cost estimates and carrying out a Level 2 life cycle cost analysis;
- Recommending the most appropriate renewal option and timeline for renewal, identifying requirements for permits and approvals; and
- Preparing and submitting a combined Detailed Condition Assessment and Renewal Option Analysis Report, including a conceptual general arrangement drawing of the recommended renewal option.

This report documents and summarizes the findings of the detailed condition assessment and renewal options analysis. The completed OSIM inspection forms are included in Appendix A. Selected inspection photographs are included in Appendix B. A memorandum summarizing the findings of the underwater inspection completed by ODS Marine is included in Appendix C. Deterioration drawings of the abutments, piers, and structural steel are included in Appendix D. The substructure condition survey letter report of the material sampling and testing results, completed by GEMTEC, is included in Appendix E. The structural steel coating analysis test results for metals content from Parcel Labs and the coating type identification analysis completed by Exova are included in Appendix F. Correspondences with relevant stakeholders are included in Appendix G. The financial analysis data of the renewal options, including cost estimates and life cycle cost analysis, and completed Detailed Condition Assessment (DCA) forms are included in Appendix H. A Preliminary General Arrangement drawing of the recommended renewal option is included in Appendix I.

2. STRUCTURE DESCRIPTION

Built in 1898, the structure carried a single railway track on the former CP Rail Montreal & Ottawa Subdivision until its abandonment in 1966 as part of the implementation of the Federal District Commission (now National Capital Commission) *Plan for the National Capital* (also known as Gréber Plan, 1950). The Old Railway Rideau River Pedestrian Bridge has since been re-purposed to carry only pedestrian and cycling traffic (Photo 3). In its current configuration, the 8-span 160.1 m long (19.9 m simply supported spans) riveted steel half deck plate girder (HDPG) structure has a 3.0 m wide curb-to-curb riding surface located between the girders (Photos

3 and 4). The bridge is on a horizontal curve alignment of 1 degree and the vertical clearance between the structure and Rideau River Western Pathway is approximately 2.5m (Photo 5).

The steel superstructures consist of 1.83 m deep riveted plate girders with a center-to-center spacing of 3.96 m and lateral bracing and cross-frames consisting mainly of angle sections. Horizontal shelf angles were riveted to the interior web of the girders to support the former deck ties and currently support the timber deck system. The structural steel is covered with a coating system consisting of a black top coat. The thermal expansion/contraction and rotation of each steel span is accommodated by steel sliding plate and spherical bearings at each abutment and each pier; expansion ends are at east ends and fixed ends are at west ends. The steel spans are supported on stone masonry piers and abutments with reinforced concrete jackets (approximately 450 mm thick), founded directly on bedrock. Nosing plates or angles are located on the upstream end of the pier shafts of Piers 1 and 2 and Piers 3 to 7, respectively.

The current deck system consists of a 38 x 140 thick laminated timber deck which is waterproofed and paved with asphalt wearing surface with a minimum thickness of 85 mm, sloped downward a 2.0% from south to north. Compression seal expansion joints are located in between spans. Timber curbs (190 x 240) are located along each side of the deck, spaced at about 3.0 m. Deck drainage is accommodated by 140 mm diameter galvanized deck drain pipes with a grate, extending below the bottom flange of the girders (3 per span), located along the interior of the north curb, while 38 x 140 drainage openings spaced at 2.0 m are located in the deck in between girders and the timber curbs. The existing railing system consists of steel pickets (i.e. posts), welded to the top flange of the girders, with two steel pipe rails.

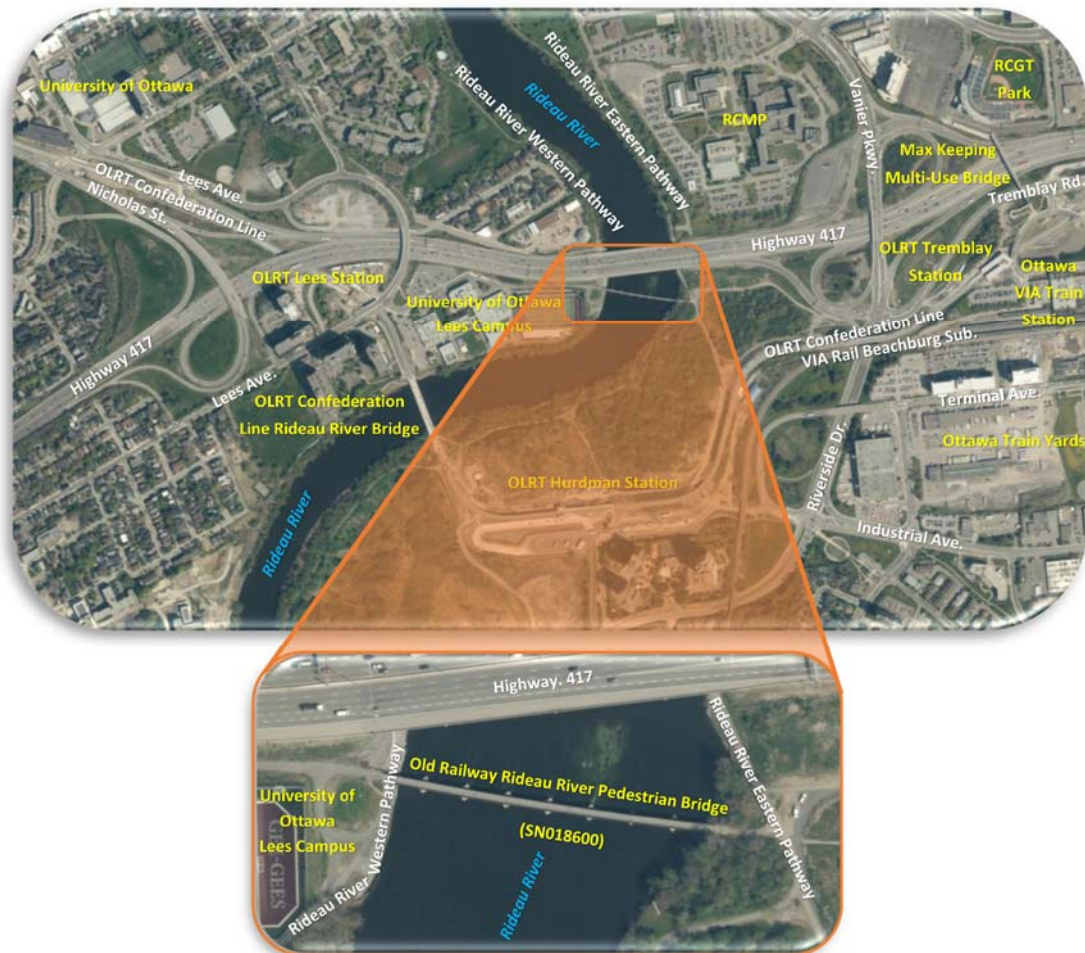

Figure 1 – Key Plan

3. DATA COLLECTION AND REVIEW

The following reports, drawings, and other data were provided by the City of Ottawa and were used to complete this assignment:

1. “2016 OSIM Inspection Report”, McIntosh Perry, April 4, 2017.
2. Miovision Database Pedestrian and Bicycle Traffic Data, June 16, 2016.
3. “2014 OSIM Inspection Report”, Stantec, March 4, 2015.
4. “Pedestrian Bridge over Rideau River Rehabilitation” As-Built Drawings, Harmer Podolak Engineering Consultants Inc., City of Ottawa Contract No. 99C3204, Sheets 1 to 6, May 1999.
5. “Br. 85.9 – M & O Subdivision, Rideau River – Hurdman, Ont., Rail Grillages and Details of Jackets for Piers 3 to 7 and East and West Abutments” Contract Drawings, Canadian Pacific Railway, Drawings B-1-2482, 2482-1 and 2482-2, April 1952.
6. “Bridge 85.9 at Hurdman, Falsework to Support Girders while Reinforcing Tops of Piers F & G” Contract Drawing, Canadian Pacific Railway, Drawing B-2-709, August 1939.

The Old Railway Rideau River Pedestrian Bridge is located on a *Major Pathway* in the City’s Cycling Network of the 2013 Transportation Master Plan (TMP). Based on the June 16, 2016 pedestrian and bicycle traffic data provided by the City, 401 pedestrians and 1,089 bicycles crossed the bridge during a 12-hour period (7:00 am to 7:00 pm).

According to available drawings provided by the City, concrete jackets were previously added to the stone masonry substructure components, including Piers 3 to 7 and both abutments in 1952 (457 mm thick), and Piers 1 and 2 circa 1940. Also, according to City records, the structural steel was sandblasted and repainted in 1969, but no information was provided to confirm this.

The latest structure rehabilitation in 1999 included the following general scope of work:

- Replacing the existing timber railway ties, tongue and groove decking and curbing with a new laminated timber deck, timber ledgers and timber curbs;
- Waterproofing and paving the deck and paving approaches;
- Installing deck drains;
- Installing expansion joints;
- Carrying out various localized structural steel repairs (i.e. replacing bottom chord of diaphragms, replacing diagonal diaphragm members, and replacing rivets in diaphragm bottom chord with bolts);
- Cleaning and repainting existing pipe railing and pickets;
- Installing additional pickets and pipe railing to increase railing height;
- Placing gabion baskets at ends of wingwalls; and
- Installing bollards on approaches.

The 2016 OSIM Inspection identified the following significant findings: numerous spalls in abutments, ballast walls and wingwalls; severe rust staining in girders between diaphragm connections and at flange and stiffeners; severe rust staining with some localized section loss at diaphragms; medium to severe transverse cracks in deck wearing surface with areas of breakup of asphalt at some joints; and the bollard was missing at the west approach.

The City’s AMB-Structures has confirmed that the pathway crossing over the structure is maintained during winter months; therefore, the structure is exposed to road salt.

4. DETAILED CONDITION SURVEY

4.1 Inspection Methodology

In October 2017 and June 2018, Parsons carried out the detailed visual inspection (Enhanced OSIM Inspection) of the entire structure (including a Level 1 underwater inspection), detailed substructure condition survey, and coating investigation in accordance with the MTO *Ontario Structure Inspection Manual (OSIM)*, *City of Ottawa 2017 Supplementary Clarification to OSIM*, *MTO Structure Rehabilitation Manual (SRM)*, and *MTO Structural Steel Coating Manual (SSCM)*, with health and safety measures implemented as per the *Occupational Health and Safety Act (OHSA)* and *MTO Safety Practices for Structure Inspections*. The detailed condition assessment of the bridge included the visual examination of all exposed surfaces of the structural components and material sampling and laboratory testing.

The structure was visually inspected to assess its condition in terms of general damage, deterioration, deficiencies and maintenance issues, with particular attention paid to the deteriorated structural steel members located below deck and deteriorated areas of concrete on the abutments and piers.

Structural steel components were examined as follows:

- Visual inspection and recording of all observed defects including cracks, structural steel coating failure or loss, corrosion, and section losses.
- Debris, pack rust, flaking paint, and scaling steel were locally removed in order to expose and observe the condition of the selected members.
- Material section loss due to corrosion on selected members was estimated by visual inspection or measured with a pit gauge.

Concrete components were examined as follows:

- Visual inspection and recording of all observed defects including cracks, spalls, scaling, disintegration, erosion, honeycombing, settlement, undermining and drainage issues.
- Delamination survey by striking the exposed concrete surfaces of suspect areas with a hammer (i.e. sounding).
- Locations and measurements of extent of defects were recorded and mapped.

All other structural and non-structural components, including the pipe handrails, laminated timber deck, timber curbs, expansion joints, deck drains, bearings, asphalt wearing surface, and embankments were inspected, and their conditions were noted.

Above-deck components were observed from the deck surface and approaches. The below-deck components at the ends of the structure, including the end spans and abutments, were inspected from the embankments with a ladder, while the inspection of hard-to-reach components of the spans located over water and piers were inspected from a floating work platform with scaffolding within the waterway.

The detailed visual inspection was carried out by Parsons. Observations of the detailed visual inspection were recorded on OSIM forms, which are included in Appendix A. Selected inspection photographs of typical defects and the overall condition of the structure are included in Appendix B. Deterioration drawings of the abutments, piers and structural steel spans are included in Appendix D.

An underwater inspection of the seven (7) in-water piers was carried out by ODS Marine to assess the condition of the concrete and the substructure/riverbed interface. The inspection was carried out using a hand-held underwater video camera. An underwater inspection memorandum completed by ODS Marine is included in Appendix C. All defects were later recorded on pier deterioration drawings included in Appendix D.

GEMTEC carried out the detailed substructure condition survey laboratory testing for compressive strength and chloride content on the concrete/stone masonry cores recovered by ODS Marine, including logging of the core samples.

Substructure condition survey material sampling and testing was completed as follows:

- Twenty (20) core samples were recovered from the substructure components, including three (3) cores from each abutment and two (2) cores from each of the seven (7) piers. The concrete/stone masonry coring and subsequent reinstatement of the cores were completed by ODS Marine.
- The concrete/stone masonry cores were tested to determine the following:
 - Concrete compressive strength was determined in accordance with CSA A23.2-14C-14 on eighteen (18) cores extracted from the abutments and piers (i.e. two from each component).
 - Chloride ion content was measured using MTO LS-417 “Method of Test for Determination of Total Chloride Ion in Concrete – Acid Soluble” on two (2) cores extracted from the abutment wingwalls (i.e. one from each abutment).
- Concrete cover to the exterior reinforcing steel layer was measured on the abutments and piers at the locations of exposed bars.

The Substructure Condition Survey Material Sampling and Testing Report completed by GEMTEC is included in Appendix E.

As part of the structural steel coating investigation, nine (9) paint chip samples were collected from the structural steel members. Eight (8) samples (i.e. one from each span) were tested by Paracel Laboratories to determine the concentration of designated substances (e.g. lead, mercury, arsenic, etc.). One (1) sample was sent to Exova for analysis to identify the existing coating system type. The results of the laboratory testing and analysis can be found in Appendix F.

4.2 Structure Identification Sheet

STRUCTURE IDENTIFICATION SHEET			
GENERAL INFORMATION			
STRUCTURE NAME	<u>Old Railway Rideau River Pedestrian Bridge</u>		
STRUCTURE NUMBER	<u>018600</u>	DISTRICT NUMBER	<u>N/A</u>
REGIONAL ROAD	Above <u>N/A</u>	Below	<u>Rideau River</u>
TYPE OF STRUCTURE	<u>Steel Half Deck Plate Girder (HDPG)</u>		
NUMBER OF SPANS	<u>8</u>	SPAN LENGTHS	<u>19.9 m</u>
ROADWAY WIDTH	<u>3.0 m</u>	YEAR BUILT	<u>1898</u>
DIRECTION OF STRUCTURE	<u>West - East</u>		
SEQUENCE NUMBER	<u>N/A</u>	TOWNSHIP NUMBER	<u>N/A</u>
LRHS NUMBER	<u>N/A</u>	BRIDGE NUMBER (Munic.)	<u>018600</u>
LOCATION	<u>South of Hwy 417</u>	JURISDICTION	<u>City of Ottawa</u>
INSPECTOR'S NAME	<u>Patrick Mergel, P.Eng., Mina Sedarous, P.Eng., Janna Golzari, EIT, Amer Hammoud, EIT and Jared Struthers</u>		
PARTY MEMBERS	<u>ODS Marine and GEMTEC</u>		
DATE OF INSPECTION	<u>June 11-15, 2018</u>		
TEMPERATURE	<u>25</u> °C	WEATHER	<u>Sunny, Rain</u>
MTO REGION	<u>Eastern</u>	AADT	<u>N/A</u>
DECK RIDING SURFACE	<u>Asphalt</u>		
YEAR LAST REHABILITATED	<u>1999</u>		
ENGINEER'S STAMP			

4.3 Summary of Significant Findings

4.3.1 Asphalt Wearing Surface and Waterproofing

The asphalt pavement on the bridge deck is in overall good condition with localized areas in fair and poor condition (3.4% of area in poor). Light to severe isolated unsealed transverse cracks were observed throughout the bridge deck (Photo 6) and light to severe progressive edge cracks, break-up and potholes at the expansion joints (Photos 7 and 8). Light ravelling was noted throughout, with localized areas of medium to severe ravelling in the area between the girder and exterior face of the timber curbs and around the deck drains (Photos 14 and 21). Due to the timber bridge deck, no cores or sawn samples were made in the asphalt wearing surface to observe the condition of the waterproofing and bond. However, the waterproofing system is assumed to be in poor condition (or non-existent) based on the observed water penetrating through the laminated timber deck during the inspection and extensive wet staining observed throughout the timber deck soffit (Photo 10). The 1999 rehabilitation as-built drawings indicate that the total thickness of the asphalt and waterproofing system is 85 mm.

The asphalt pavement on the approaches is in overall good condition, but with localized areas in fair condition due to light ravelling throughout with localized areas of medium ravelling along the expansion joints and wingwalls (Photo 9). Additionally, there are localized areas of light progressive edge cracking at the east approach.

4.3.2 Timber Deck

The deck top is completely covered with an asphalt wearing surface and could not be visually inspected, as no cores or sawn samples were made in the asphalt and waterproofing system to observe the condition of the deck top due to the risk in comprising the structure, since it's laminated timber deck, not a concrete deck. The condition of the deck top was rated based on the "top-down"/"bottom-up" defects noted in the deck wearing surface in accordance with OSIM, which was also used for the ratings of the 2014 and 2016 OSIM Inspections, though the rating system presented in the OSIM was for asphalt covered concrete decks, not timber decks, therefore the defects in the defects may not correlate entirely with defects in the timber deck top. The deck top is in overall good condition with localized areas in fair and poor (1.3% of area in poor) due to potholes, break-up and severe progressive edge cracks, severe isolated transverse cracks.

The interior and ends of the laminated timber deck soffit and timber ledgers are in overall good condition. Wet staining was observed throughout the soffit (Photo 10), likely from water penetrating through the asphalt and at the expansion joints and along the interior webs of the girders (water was observing penetrating the deck soffit while raining during the inspection). Additionally, there are multiple light to severe shakes and splits present in the laminated timber deck and timber ledgers (Photo 11).

4.3.3 Timber Curbs

The north and south timber curbs on the bridge deck are in generally good condition with localized areas in fair and poor condition due to severe to very severe impact damage at all four (4) ends of the timber curbs (Photos 12 and 13), likely due to snow plows, light to medium localized checks and splits in all curb faces, and light to severe longitudinal splits extending from the bolts throughout the top face of curb (Photo 14). Additionally, there is light rot and weathering (Photos 12 to 14).

4.3.4 Expansion Joints

The expansion joints are suspected to be in generally poor condition. The compression seal is broken at Pier 2 (Photo 15) and the seals at the west abutment and Pier 4 are visibly sagging beneath the deck (Photos 16 to 18). The material condition of the remaining compression seals is in generally good condition; however,

there is evidence of water penetration through the expansion joints due to concrete deterioration on pier bearing seats below the joints, as well as very severe corrosion on the end cross-frames, and wet staining on the soffit of the laminated timber deck.

The expansion joint armouring angles are in generally good condition; however, they are anchored to the deck soffit instead of the top of deck as shown in the details in the 1999 rehabilitation as-built drawings (Photo 17). There are localized areas in poor condition at Pier 3, Pier 6 and Pier 7 due to collision damage to the top of steel armouring angles (Photos 7 and 8). Additionally, there is localized light corrosion on the above-deck steel angles and light to medium corrosion on the bolts of the angles below deck (Photo 17).

4.3.5 Deck Drainage System

The deck drains in the deck top are located on the interior side of the north timber curb and are in generally good condition (Photo 19). The downspouts extend below the structural steel and have localized light corrosion on the ends (Photo 20).

The rectangular deck drainage openings are located on the exterior side of the timber curbs between the girders on both sides of the deck (Photo 21) and are typically in good condition, though a splintered piece of timber is lodged in the drainage opening at the southeast corner of the bridge (Photo 11). A significant performance defect noted with the rectangular deck drainage openings is that they do not have any downspouts and terminate just below the timber deck soffit (Photo 22); as such, deck drainage outlets directly onto the structural components located directly below the drainage openings, which is directly exposing the structural steel below deck to deck drainage, including salt-laden runoff as the pathway over the structure is maintained during winter months.

4.3.6 Bridge Railing System

Seventy-three (73) mm outer diameter painted double steel pipe rails and steel pickets are welded to the top flange of each girder. The railings are in overall good condition with localized light corrosion throughout the steel pipes and steel pickets (Photos 6).

The steel railing coating system is in overall good condition with localized areas in fair and poor condition due to localized coating failure on the steel rails and pickets with medium to severe surface rust due to undercutting (Photo 23).

4.3.7 Approach Barriers

The painted steel railing system consisting of three rails with steel square posts embedded into the top of the concrete wingwalls on each approach is in overall poor condition (Photo 24) due to severe to very severe corrosion at the base of the railing posts with up to 75% section loss (Photos 24 and 25).

The steel railing coating system is in overall good condition with localized areas in fair and poor condition due to light to severe surface rust throughout the rails and posts (Photo 24).

4.3.8 Structural Steel

The girders are in generally good to fair condition with localized areas in poor condition (5.0% of area in poor). The exterior surfaces of the girders are in generally good condition with localized light corrosion (Photos 26 and 27). The interior surfaces above-deck of the girders are in good condition with localized areas in fair to poor condition, including a cracked and deformed cover plate due to impact damage to the west end of the south girder (Photo 28) and deformation of the bottom flange at the west end of the south girder of Span 7 just above Pier 7 (Photo 46). Typical light to medium corrosion was noted on the girder web and knee braces

(i.e. vertical gusset plates) in contact with the top of the asphalt wearing surface (Photo 27) and light to medium corrosion with rust jacking on the interior top flange between cover plates (Photo 29). The interior surfaces below-deck of the girders are in generally fair condition with localized areas in poor condition due medium to severe corrosion with rust jacking throughout the bottom flanges, and medium to very severe corrosion throughout the horizontal shelf angles (Photo 30) and rivet heads (up to 100% section loss). Also, there is light to medium corrosion throughout the web of the girders and light to very severe corrosion throughout the vertical stiffeners (Photo 30).

The cross-frames (i.e. diaphragms) are in overall poor condition with severe to very severe corrosion and perforations in multiple locations at each cross-frame. Very severe corrosion with 20 to 100 % section loss with rust jacking and localized small to very large perforations is typical in the top and bottom braces (Photos 31 to 34 and 37), including a section of severe deformation of the top brace of the cross-frame 2 bays west of Pier 5 (Photo 35). Medium to very severe corrosion is typical throughout the diagonal braces and vertical gusset plates, some with localized small perforations (Photo 36), as well as severe to very severe corrosion with up to 100% section loss on the rivet heads at all the steel member connections (Photo 37).

The lateral bracing members are in overall poor condition with numerous locations of severe to very severe corrosion and perforations in the diagonal braces, horizontal gusset plates and/or rivets, along with multiple cases of complete detachment of the diagonal members from the horizontal gusset plates (Photos 38 to 40) where the deterioration is typically the most severe. Light to medium corrosion typical throughout the diagonal members (Photo 41).

4.3.9 Structural Steel Coating System

It was suspected that existing coating system applied in 1969 (according to City records) consisted of three (3) layers (i.e. dark grey/black top coat, white mid coat, and orange primer) and was a lead-based alkyd system due to its age. According to the paint sample test results presented in Section 4.4.3, the coating system actually consists of five (5) layers (i.e. additional orange and dark grey/black layers) of an alkyd-based system and has very high lead concentrations.

The structural steel coating system is in generally in poor condition with widespread coating deterioration on all below-deck structural steel components, including severe surface rust, undercutting and peeling throughout all structural steel components, which has resulted in light to very severe corrosion present on all steel members (Photos 30 to 41). The exterior and above-deck structural steel coating system is in generally good condition (Photo 42) with localized areas in poor condition, including peeling underneath the exterior top flange of the girders (Photo 25), severe surface rust on the top and bottom girder flanges, exterior web of girders, and at the asphalt/girder interface on the interior web of girders (Photos 26 to 29).

4.3.10 Bearings

The existing steel bearings were installed during the 1952 rehabilitation of the piers. The west abutment bearings and east pier bearings are fixed spherical disc plate and plate bearings and the east abutment bearings and west pier bearings are expansion spherical disc plate with sliding plate bearings. The bearings are in overall fair to poor condition with extensive coating deterioration, including severe surface rust, undercutting, and peeling, resulting in light to severe corrosion on bearing surfaces and significant accumulation of flaking corroded steel and debris on the interior of the bearings, which is suspected to be impeding bearing movement (Photos 43 to 45). The southeast bearing on Pier 7 has a cracked steel casing that has been temporarily repaired with a clamping device (Photo 46) and it is suspected to be non-uniformly loaded due to the deformation of the steel casing; the nut is not tightened down on this fixed bearing anchor bolt (Photo 46). The anchor bolt at the northwest expansion bearing at Pier 4 has sheared off (Photo 47).

4.3.11 Abutments

The abutments were rehabilitated in 1952, including reinforced concrete jacketing the existing stone masonry abutment walls, bearing seats and wingwalls, and replacing the existing stone masonry ballast walls with concrete ballast walls.

The east abutment wall, bearing seat and exposed footing are in generally poor condition (62.1% of area in poor) with numerous severe to very severe delaminations, spalls and extensive disintegration up to 150 mm deep with exposed corroded reinforcing steel (Photos 48 to 51). The west abutment wall and bearing seat are in generally good condition with localized areas in poor condition (4% of area in poor) with severe to very severe disintegration at the top of the abutment wall and bearing seat at the north end (Photo 52). Wet efflorescence stained hairline pattern cracking was noted in the bearing seat and light popouts throughout the abutment wall. There is a significant accumulation of debris on both bearing seats, including deteriorated steel and concrete (Photos 43 and 44). Also, there is non-offensive graffiti present on both abutment walls (Photos 48 and 52), though the west abutment wall has been previously painted.

Both ballast walls are in overall fair condition with significant areas in poor condition (26.9% of area in poor) on the north and south ends of the walls due to severe to very severe spalls, delaminations and disintegration up to 150 mm deep with exposed corroded rebar (Photos 53, 54, 56 and 58). Additionally, wet and efflorescence stained hairline to narrow map cracking was noted throughout both walls (Photos 55 and 57), medium and wide vertical and horizontal cracks on the east ballast wall, and medium honeycombing and wet staining in the west ballast wall (Photo 55).

The southeast (Photo 58) and northeast (Photo 59) wingwalls are in generally poor condition, while the southwest (Photo 60) and northwest (Photo 61) wingwalls are in generally fair condition with areas in poor condition concentrated at the west ballast wall and top of wingwalls (33.7% of total area in poor). Noted defects include light to very severe disintegration up to 150 mm deep, spalls and delaminations with exposed corroded rebar in all wingwalls, wet and efflorescence stained hairline to narrow map cracking in all wingwalls, medium to wide horizontal crack on the southwest wingwall, and a localized area of medium scaling and medium honeycombing along a horizontal construction joint on the northwest wingwall. There is also non-offensive graffiti on the southeast, northeast and northwest wingwalls.

4.3.12 Piers

Piers 3 to 7 were rehabilitated in 1952, including reinforced concrete jacketing the existing stone masonry pier shafts, bearing seats, and footings. The concrete jacketing of Piers 1 and 2 was not included in the 1952 rehabilitation drawings, as concrete jacketing of these piers is suspected to have taken place circa 1940.

Piers 3 to 7 are in overall poor condition and Piers 1 and 2 are in overall fair condition with localized areas of poor condition (18.5% of total area in poor). Observed defects include severe to very severe disintegration with exposed corroded reinforcing steel and delaminations on and below the bearing seats of Piers 1, 3 and 5 to 7, (Photos 47, 64 and 66 to 69) and throughout all surfaces of Pier 4 (Photo 65). Localized defects on the pier shafts and footings include light to very severe disintegration, spalls and delaminations, hairline to wide horizontal and vertical cracks (including horizontal construction joints) and map cracking with and without efflorescence, light to very severe scaling, rust staining due to corroding rebars, and extensive wet and efflorescence staining (Photos 62, 64, 67, 68 and 71). There is significant accumulation of debris on most pier bearing seats, including deteriorated steel and concrete (Photo 45). There is also non-offensive graffiti on Piers 1, 3 and 7.

The Level 1 underwater visual inspection of the pier footings noted two locations of severe undermining on the upstream ends of the footings: approximately 600 mm long x 100 mm high x 300 mm deep at the

southeast corner of the Pier 5 footing and 600 mm long x 300 mm high x 450 mm deep at the southeast corner of the Pier 6 footing (Photo 70). Numerous localized areas of shallow undermining, 75 to 100 mm deep, were noted predominantly on the south (upstream) end of each pier. See Appendix C for more details.

The steel nosing plates and/or angles on the shafts and footings of Piers 3 to 7 are in generally good condition with light corrosion and in poor condition on Piers 1 and 2 due to the separation, detachment and folding back of the nosing plate on the southeast face of Pier 1 (Photo 62) and a very wide vertical crack extending from the top to halfway down the center of the steel nosing plate of Pier 2 (Photo 63). No steel nosing plates and/or angles are located on the upstream footings of Piers 1 and 2 (Photos 62 and 63).

4.3.13 Embankments and Slope Protection

The embankments are in generally good condition, except for the embankment in front of the east abutment, which is in fair condition due to erosion of embankment material greater than 10%, likely due to high flows (Photo 72). The side slope embankments at the southwest and northwest are moderately sloped, but southwest embankment has well vegetated with light erosion due to a foot path (Photo 73), while the northwest embankment is covered in rip-rap (Photo 74). The embankment in front of the west abutment and Rideau River Western Pathway is covered with rip-rap. The side slope embankments at the southeast and northeast are steeply sloped and well vegetated no significant erosion (Photo 72).

The rip-rap slope protection in front of the west abutment and on the northwest embankment (Photo 74) is in good condition.

4.3.14 Waterway

The Rideau River flows from south to north beneath the bridge with a riverbed consisting of bedrock or with a shallow layer of silt and sand on bedrock (Photo 75). The waterway is in good condition (Photos 1 and 2) with only a few locations aggradation of the streambed at the downstream end of the piers and a few locations of scouring of the streambed at the upstream end of the piers (Photos 64 and 70). The average water depth adjacent to the piers was approximately 400 mm (Photo 75) and the flow clearance from the bottom of the girders to the water level was approximately 4.2 m on June 11, 2018.

4.3.15 Retaining Walls

Three (3) 2 m long x 1 m high x 1 m deep gabion baskets are located at the ends of the northwest (Photo 76), northeast (Photo 77), and southeast wingwalls and they are generally in good condition with only slight bulging of the end basket at the northeast.

4.4 Field Investigation and Laboratory Testing

4.4.1 Abutments

Two (2) core samples were extracted from the front face of the east abutment wall. The compressive strength test results were 13.6 MPa and 24.8 MPa with an average compressive strength of 19.2 MPa, which is 7% lower than the specified concrete compressive strength at 28 days of 3,000 psi (20.7 MPa) indicated on the original construction drawings. As the compressive strength of Core 2 was lower than 20 MPa, the concrete is considered poor quality in accordance with the MTO *Structure Rehabilitation Manual*. Two (2) core samples were extracted from the front face of the west abutment wall. The compressive strength test results were 29.0 MPa and 53.2 MPa with an average compressive strength of 41.1 MPa, which is double the specified concrete compressive strength at 28 days of 3,000 psi (20.7 MPa) indicated on the original construction drawings.

One (1) core sample was extracted from the northeast wingwall and one (1) from the northwest wingwall. The east abutment wingwall has a corrected acid soluble chloride ion content of 0.045% (after subtracting a background chloride ion content of 0.027% for the parent concrete) at the reinforcing steel depth of 100 mm as seen in Core 3. The corrected chloride content at the rebar depth is 0.020% higher than the threshold value of 0.025% to initiate corrosion, thus significant corrosion of the reinforcing steel in the northeast wingwall is likely, which is also supported by the severe rusting of the reinforcing steel present in Core 3. The west abutment wingwall has a corrected acid soluble chloride ion content of 0.000% at the reinforcing steel depth of 76 mm as seen in Core 20. The corrected chloride content at the rebar depth is lower than the threshold value of 0.025% to initiate corrosion, thus significant corrosion of the reinforcing steel in the northwest wingwall is unlikely, which is also supported by the lack of corrosion on the reinforcing steel in Core 20.

The cores showed plain cement concrete or concrete refacing depths exceeding 533 mm from the stone masonry face with 22 mm diameter reinforcing steel. The original construction drawings specified a concrete refacing thickness of 457 mm (1'-6") using 19 mm (3/4") diameter rebar for both abutments.

The cores in the east abutment showed signs of poor quality concrete, as they exhibited signs of weathering due to frost action with horizontal cracking in the upper portion, delaminations, scaling, breaks, corroded rebar, and a compressive strength of less than 20 MPa. The concrete cores in the west abutment were generally in good condition with breaks and cracks only at the stone masonry and concrete interface, although, they exhibited signs of weathering due to frost-action.

The core sample locations are shown on the abutment deterioration drawings included in Appendix D. Further details regarding the abutment sampling and testing results can be found in GEMTEC's report in Appendix E.

4.4.2 Piers

One (1) core sample was extracted from the east and west faces of each pier, a total of fourteen (14) cores. The concrete compressive strength test results ranged from 14.0 MPa to 48.0 MPa with an average compressive strength of 30.9 MPa, which is 49% higher than the specified concrete compressive strength at 28 days of 3,000 psi (20.7 MPa) indicated on the original construction drawings. The compressive strength of Cores 10 and 11 from Pier 4 and Core 16 from Pier 7 were lower than 20 MPa; the concrete is considered poor quality in accordance with the MTO *Structure Rehabilitation Manual*. It is noted that a compressive strength test result of 91.4 MPa was obtained for an inner stone masonry section of Pier 1 (Core 5).

The cores showed plain cement concrete and/or concrete refacing depths ranging from 305 to 620 mm from the stone masonry face with 21 to 22 mm diameter reinforcing steel. The original construction drawings specified a concrete refacing thickness of 457 mm (1'-6") using 19 mm (3/4") diameter rebar for Piers 3 to 7. Cores 6 and 7 from Pier 2 revealed a fine (sand) plain cement concrete refacing ranging from 80 to 130 mm from a stone masonry/plain cement concrete layer, and no reinforcing steel was observed in these cores.

Most cores were observed to have visual deterioration of the surface of the concrete down to various depths, most likely due to frost-action from the non-air entrained concrete. Delaminations and breaks were observed at the interface between the stone masonry and concrete and/or at rebar locations in most cores, while delamination, cracking and breaks within the concrete were observed in Cores 4, 8, 9, 11, 15 and 16, and light corrosion of the rebar observed in most cores. It is also noted that wire mesh was found at the concrete and stone masonry interface in Core 17.

The core sample locations are shown on the pier deterioration drawings included in Appendix D. Further details regarding the pier sampling and testing results can be found in GEMTEC's report in Appendix E.

4.4.3 Structural Steel Coating System

Identification Analysis

Parsons staff retrieved a representative paint chip sample from the existing structural steel coating on a cross frame from Span 7 which was submitted to Exova Group’s Mississauga laboratory for paint type identification. The generic identification of the polymeric binder in each layer of the sample was carried out using Fourier Transform Infrared (FTIR) spectroscopy. The results of the analysis indicate that the existing structural steel coating system consists of five (5) layers (from bottom to top): orange, white, dark grey/black, orange and dark grey/black and the paint type in all layers are generically identified as an *alkyd resin* (i.e. alkyd-based paint system with lead or chromium suspected to be the corrosion inhibitor). The Identification Analysis report by Exova is included in Appendix F.

Metals Concentration Analysis

Parsons staff retrieved eight (8) representative paint chip samples from the existing structural steel coating of the bridge at the following locations: one (1) from a Span 1 cross-frame, one (1) from a Span 2 interior of girder, one (1) from a Span 3 interior of girder, one (1) from a Span 4 cross-frame, one (1) from the Span 5 interior web of north girder, one (1) from a Span 6 cross-frame, one (1) from a Span 7 cross-frame, and one (1) from a Span 8 lateral brace. The paint chip samples were submitted to Paracel Laboratories Ltd. in Ottawa metals concentration analysis. Lead is a *designated substance* in accordance with O. Reg. 490/09 of the *Occupational Health and Safety Act* (OHS) and the most commonly found metal in older coating systems. Mercury and Arsenic are also *designated substances* in accordance with O. Reg. 490/09 of the OHS and often found in older coating systems. A summary of the analysis results is given below in Table 1. Refer to Appendix F for the complete metals concentration analysis results from Paracel.

Table 1: Lead, Mercury and Arsenic Concentrations in the Structural Steel Coating System

Sample #	Location of Paint Sample	Lead Concentration (ppm)	Mercury Concentration (ppm)	Arsenic Concentration (ppm)
1	Span 1 cross-frame	227,000	39	<50
2	Span 2 interior of girder	109,000	86	<50
3	Span 3 interior of girder	118,000	96	<50
4	Span 4 cross-frame	98,000	70	<50
5	Span 5 interior web of north girder	118,000	43	<50
6	Span 6 cross-frame	135,000	62	<50
7	Span 7 cross-frame	97,400	46	<50
8	Span 8 lateral brace	255,000	25	<50

In accordance with the *Hazardous Products Act*, the current *Surface Coating Materials Regulations*, SOR/2016-193 (current to August 27, 2018) limits the concentration of total lead present in surface coating materials to 90 mg/kg (or parts per million (ppm)). The lead concentration in the paint samples tested ranged from 97,400 to 255,000 ppm (confirming Exova’s assumption of lead as the corrosion inhibitor), indicating that all locations of the structural steel coating system have lead concentrations greatly exceeding the current acceptable limit for surface coatings.

The SOR/2016-193 (current to August 27, 2018) regulation limits the concentration of total mercury present in surface coating materials to 10 mg/kg or ppm. The mercury concentration in the paint chip samples tested ranged from 25 to 96 ppm, indicating that all locations of the structural steel coating system have mercury concentrations exceeding the current acceptable limit for surface coatings.

The reporting limit for arsenic content for the purposes of the analysis was 50 ppm; thus, no arsenic concentration above the minimum reporting limit was detected in any of the paint chip samples tested.

Consequently, any structural steel re-coating work would have to consider all protective measures necessary for lead and mercury abatement in accordance with current Ontario Ministry of Labour (MOL) regulations and guidelines, and appropriate environmental regulations for waste management and disposal. The MOL document entitled *Guideline, Lead on Construction Projects* (revised April 2011) is used to dictate safe working conditions with respect to lead containing paint during coating rehabilitation work and all measures necessary for appropriate waste management will need to be implemented in accordance with Ontario Regulation, O. Reg. 347.

5. RENEWAL OPTIONS ANALYSIS

Based on the results of the detailed condition assessment, the structure is in overall “poor” condition. Several components are exhibiting significant deterioration (i.e. expansion joints, structural steel below deck, structural steel coating system below deck and steel railing coating system, bearings, east abutment wall, ballast walls, wingwalls, and piers) and several components are exhibiting localized areas of deterioration (i.e. deck wearing surface, structural steel above deck, structural steel coating system exterior and above deck, west abutment wall, timber curbs, approach railing system, and east embankment), which require rehabilitation or replacement, if the City intends to extend the service life of the structure:

- The *asphalt wearing surface* is in overall good condition, but exhibiting localized areas of deterioration throughout due to light to severe isolated unsealed transverse cracks, light to severe progressive edge cracks, break-up and potholes at the expansion joints, and light ravelling with localized areas of medium to severe ravelling in the area between the girder and exterior face of the timber curbs. Based on the field observations during the detailed condition survey (i.e. extensive wet staining on soffit of timber deck and water penetration through timber deck during rain event), it is uncertain whether the *bridge deck waterproofing system* is present on the bridge deck. If it is, it would be considered in poor condition. The asphalt wearing surface and waterproofing system were installed on the bridge deck during the last major rehabilitation in 1999.

Having now been in service for over 19 years, the asphalt wearing surface is still serviceable on this multi-use crossing, and only requires localized maintenance repairs at this time. If present, the bridge deck waterproofing system requires replacement due to water penetration through the deck.

- The *bridge laminated timber deck* is considered to be in good condition, despite water penetrating through the asphalt, at the expansion joints, and along the interior webs of the girders.

No bridge deck repairs are recommended at this time.

- The *timber curbs* are in good condition with localized defects, including severe to very severe impact damage at all both ends of the timber curbs, likely due to snow plows, light to medium localized checks and splits in all curb faces, and light to severe longitudinal splits throughout the top face of curb.

Only maintenance repairs are required at this time to replace the ends of the timber curbs.

- The *expansion joints* are suspected to be in generally poor condition, including a broken compression seal at Pier 2 and the seals at the west abutment and Pier 4 are visibly sagging beneath the deck. The material condition of the remaining compression seals is in generally good condition; however, there is evidence of water penetration through the expansion joints due to concrete deterioration on pier bearing seats below the joints, as well as very severe corrosion on the end cross-frames, and wet staining on the soffit of the laminated timber deck.

At a minimum, the compression seals require replacement, but it is recommended to replace the entire expansion joint assemblies due to poor detailing (i.e. seal retention).

- The *deck drainage openings* have a significant performance defect as they do not have any downspouts and terminate just below the timber deck soffit; deck drainage outlets directly onto the structural components located directly below the drainage openings, which is directly exposing the structural steel below deck to deck drainage, including salt-laden runoff as the pathway over the structure is maintained during winter months.

It is recommended that all 160 drainage openings be extended below the structural steel girders.

- The *structural steel* below deck is in fair to poor condition due to medium to severe corrosion with rust jacking throughout the girder bottom flanges, medium to very severe corrosion on the horizontal shelf angles, light to medium corrosion throughout the interior web of the girders, light to very severe corrosion on the vertical stiffeners, severe to very severe corrosion and perforations in multiple locations at each cross-frame (including vertical gusset plates), a section of severe deformation on a top brace of a cross-frame west of Pier 5, severe to very severe corrosion on the rivet heads at all steel member connections, numerous locations of severe to very severe corrosion and perforations on the lateral braces, horizontal gusset plates and/or rivets with multiple cases of complete detachment of the diagonal members from the horizontal gusset plates, light to medium corrosion typical throughout the diagonal members, and deformation of the bottom flange at the west end of the south girder of Span 7 just above Pier 7.

The *structural steel* above deck is in generally good condition with localized areas of deterioration, including a cracked and deformed cover plate due to impact damage to the west end of the south girder, light to medium corrosion on the girder web and knee braces (i.e. vertical gusset plates) in contact with the asphalt wearing surface, and light to medium corrosion with rust jacking on the interior top flange between cover plates.

It is recommended to carry out significant structural steel repairs to the members located below the bridge deck, including replacement of all lateral braces (including horizontal gusset plates), all cross-frames (including vertical gusset plates), all horizontal shelf angles, localized interior vertical stiffeners, and localized rivets with high strength bolts.

- The *structural steel coating system* has been in service for 49 years, long since exceeding its expected service life, and is in generally in poor condition with widespread coating deterioration on all below-deck structural steel components, including severe surface rust, undercutting and peeling throughout all structural steel components, which has resulted in light to very severe corrosion present on all steel members. The exterior and above-deck structural steel coating system is in generally good condition with localized areas in poor condition, including peeling underneath the exterior top flange of the girders, severe surface rust on the top and bottom girder flanges, exterior web of girders, and at the asphalt/girder interface on the interior web of girders.

The coating system on the exterior face of the girders and above deck is in generally good condition. Although localized coating touch-up and zone coating repairs were initially considered for these surfaces, there will be no cost savings for the access or environmental protection requirements (including lead abatement) for this option (which are significant costs), as full recoating is still required

for all remaining structural steel located below deck, and the unit rate for localized repairs is higher than full recoating, as it is more labour intensive. Given that the coating system has long surpassed its expected service life and will not provide the required long-term corrosion protection, it is recommended that all remaining structural steel be fully recoated, including the bridge railing systems.

- The steel spherical disc plate and plate *bearings* are in overall fair to poor condition with extensive coating deterioration, resulting in light to severe corrosion on bearing surfaces and significant accumulation of flaking corroded steel and debris on the interior of the bearings, which is suspected to be impeding bearing movement. The southeast bearing on Pier 7 has a cracked steel casing that has been temporarily repaired with a clamping device and it is suspected to be non-uniformly loaded due to the deformation of the steel casing; the nut is not tightened down on this fixed bearing anchor bolt. The anchor bolt at the northwest expansion bearing at Pier 4 has sheared off. The estimated service life of bearings is 25-50 years, in accordance with the MTO *Structural Financial Analysis Manual* (SFAM). The bearings were installed during the 1952 rehabilitation and are now 66 years old, long since exceeding their expected service life.

The bearings are at the end of their service life and are recommended to be replaced in conjunction with the extensive concrete repairs that are recommended to the abutments and piers, which will require jacking of the superstructure spans.

- The *east abutment wall, bearing seat* and exposed *footing* are in generally poor condition with numerous severe to very severe delaminations, spalls and extensive disintegration up to 150 mm deep with exposed corroded reinforcing steel. The compressive strength test results yielded an average strength of 19.2 MPa, which is 7% lower than the specified strength at 28 days of 20.7 MPa, indicating that the concrete is considered poor quality, as it was lower than 20 MPa.

The *west abutment wall and bearing seat* are in generally good condition with localized areas of deterioration, including severe to very severe disintegration at the top of the abutment wall and bearing seat at the north end. Wet efflorescence stained hairline pattern cracking was noted in the bearing seat and light popouts throughout the abutment wall. The compressive strength test results yielded an average strength of 41.1 MPa, which is double the specified strength at 28 days of 20.7 MPa.

The concrete used in the jacketing of each abutment was not air-entrained and is susceptible to freeze-thaw action, which has resulted in very severe disintegration of all concrete components in the abutments. There is a significant accumulation of debris on both bearing seats and graffiti on both abutment walls.

It is recommended that the east and west abutment walls be refaced along with the bearing seats. The bearing seats should be reconstructed to include bearing pedestals and to provide positive drainage away from the ballast walls. Accumulation of debris on the bearings and graffiti on the abutments should be cleaned.

- The *ballast walls* are in overall fair condition with significant areas of deterioration on the north and south ends of the walls due to severe to very severe spalls, delaminations and disintegration up to 150 mm deep with exposed corroded rebar. Also, wet and efflorescence stained hairline to narrow map cracking was noted throughout both walls, medium and wide vertical and horizontal cracks on the east ballast wall, and medium honeycombing and wet staining in the west ballast wall.

It is recommended that the ballast walls be refaced.

- The *wingwalls* at the southeast and northeast are in generally poor condition, while the southwest and northwest are in generally fair condition with deteriorated areas concentrated at the west ballast wall and top of wingwalls, including light to very severe disintegration up to 150 mm deep, spalls and delaminations with exposed corroded rebar in all wingwalls, wet and efflorescence stained hairline to

narrow map cracking in all wingwalls, medium to wide horizontal crack on the southwest wingwall, and a localized area of medium scaling and medium honeycombing along a horizontal construction joint on the northwest wingwall. The northeast wingwall has a corrected acid soluble chloride ion content of 0.045% (after subtracting a background chloride ion content of 0.027% for the parent concrete) at the reinforcing steel depth of 100 mm, which is 0.020% higher than the threshold value of 0.025% to initiate corrosion. There is graffiti on the southeast, northeast and northwest wingwalls.

It is recommended that the wingwalls be refaced and that graffiti be cleaned from the walls.

- *Piers 3 to 7* are in overall poor condition and *Piers 1 and 2* are in overall fair condition with localized defects, including severe to very severe disintegration with exposed corroded reinforcing steel and delaminations on and below the bearing seats of Piers 1, 3 and 5 to 7, and throughout all surfaces of Pier 4. Localized defects on the pier shafts and footings include light to very severe disintegration, spalls and delaminations, hairline to wide horizontal and vertical cracks (including horizontal construction joints) and map cracking with and without efflorescence, light to very severe scaling, rust staining due to corroding rebars, and extensive wet and efflorescence staining. The compressive strength test results yielded an average strength of 30.9 MPa, which is 49% higher than the specified strength at 28 days of 20.7 MPa. The compressive strength of Cores 10 and 11 from Pier 4 and Core 16 from Pier 7 were lower than 20 MPa; the concrete is considered poor quality.

The concrete used in the jacketing of each abutment was not air-entrained and is susceptible to freeze-thaw action, which has resulted in very severe disintegration on most pier faces and bearing seats. There is significant accumulation of debris on most pier bearing seats and graffiti on Piers 1, 3 and 7.

It is recommended that all pier shafts be refaced along with the bearing seats. The bearing seats should be reconstructed to include bearing pedestals and to provide positive drainage away from the ballast walls. Accumulation of debris on the bearings and graffiti on the piers should be cleaned.

- The *approach railing system* are in overall poor condition due to localized severe to very severe corrosion (with up to 75% section loss) at the base of the railing posts embedded into the top of the concrete wingwalls.

It is recommended that the approach railings be replaced with new pedestrian pipe railings.

- The *east embankment* is in overall fair condition due to loss of material due to erosion.

It is recommended that the missing fill be reinstated and rock protection be placed in front of the east abutment and on the adjacent side slope embankments.

5.1 Renewal Options

Based on the results of the detailed condition assessment, one (1) rehabilitation option and one (1) replacement option are developed below for the renewal of the existing structure. A renewal option which included superstructure replacement on existing substructure components was briefly considered, but it was determined that it was not worth exploring further due in part to the following reasons:

1. Age and deterioration of existing substructure. The existing substructure is already 120 years old and has already undergone a major rehab in the 1940s/1950s, and would require another as part the structure replacement, but over the design life of the new superstructure, the substructure would likely require 1 or 2 more major rehabs to extend their service life to about 200 years (end of service life of a new superstructure). As such, the long-term maintenance costs of the existing substructure vs. a new substructure would be significantly higher.
2. Adherence to current CHBDC. If a new superstructure is constructed on the existing concrete jacketed-masonry substructure (cast on bedrock, not socketed or doweled into bedrock), the substructure would

have meet current CHBDC loading, including seismic requirements, therefore additional seismic retrofit costs (e.g. strengthening, isolation, etc.) would have to be included without any knowledge of the current deficiencies, as a structural/seismic evaluation was not part of the study.

3. Constraining the new superstructure to the existing horizontal alignment. The existing bridge alignment is on a curve, not a tangent, therefore the new superstructure would have to be curved in the horizontal plane, adding to the construction complexities and costs.
4. Constraining new superstructure to existing piers. The existing pier arrangement with equal span lengths is not beneficial for the moment distribution of a continuous span configuration (in order to eliminate expansion joints) for the superstructure replacement, resulting in a highly inefficient design.
5. The existing substructure would still require modifications to accommodate new superstructure, including raising height of piers to accommodate an acceptable vertical profile to provide adequate drainage to either ends.
6. In addition, there would be more or less the same traffic impacts as the construction duration and impacts to the adjacent pathway would not differ greatly from a complete rehabilitation option, but the environmental impacts would not be significantly less, as causeways still need to be built across the river for access to remove existing/construct new spans and pier rehabilitation work and cofferdams still need to be built around all existing piers, whether for rehabilitation or demolition of non-utilized piers (though the duration of demolition cofferdams is less).

For the purposes of evaluating the renewal options, the service life of existing structures is typically assumed to be 75 years, which is consistent with the 75-year design life specified for new structures in the current Canadian Highway Bridge Design Code (CHBDC), CSA S6-14. Constructed in 1898 as a railway bridge, the existing bridge is 120 years old and has therefore long since exceeded its expected service life. However, considering that at some point since the abandonment of railway line in 1966, the bridge was repurposed as a pedestrian/cycling bridge (i.e. significantly reducing loading on the structure), and given the current condition of the structure, it is anticipated that with a major rehabilitation and regular maintenance, the bridge could remain in service until 2048 (i.e. approx. 30 years), at which time it would be replaced.

The assumed life span ranges of various structural elements and rehabilitation treatments are based on those detailed in Appendix A.1.3 of the MTO *Structural Financial Analysis Manual* (SFAM). For the purpose of the analysis, assumed life spans of 15 years will be used for mill and pave, 15 years for replacing expansion joint strip seals, 15 years for concrete patch repairs, 20 years for a new low VOC three coat system, 25 years for concrete refacing, 25 years for a laminated timber deck, 30 years for patch, waterproof and pave, 30 years for replacing entire expansion joint assembly, and 50 years for replacing bearings.

Based on the existing condition of the structure, the major renewal should be completed within the 1 to 5-year timeframe (i.e. 2019 – 2023). With ongoing maintenance work to keep the structure serviceable to users, the renewal date of both options is selected as 2023, as the City needs to secure funding, carry out the design and preparation of contract documents, and obtain required environmental approvals.

In addition, in consultation with the City's Transportation Planning staff as part of this renewal options study, bridge rehabilitation and replacement renewal options should include bridge lighting, as nearby pathways will be receiving lighting in the future (i.e. completed in the next decade or two as development occurs), as a significant increase in cycling volumes is expected across the bridge once Stage 1 LRT opens in early 2019, providing a direct link to Downtown, and further increases are expected as the Transit-Oriented Development (TOD) areas around Lees, Hurdman and Tremblay Stations are developed. All correspondences with the stakeholders are included in Appendix G.

The following rehabilitation option and replacement option are considered for renewal of the structure:

Option 1: Major Rehabilitation in 2023 (Structure Replacement in 2048)

This option involves carrying out a major renewal contract in 2023 to repair/replace the deteriorated components of the structure. The scope of work would include the following work:

- Replace timber bridge deck system, including expansion joint assemblies, timber curbs, deck drains and asphalt wearing surface
- Replace all lateral braces, cross frames, shelf angles, and localized interior vertical stiffeners
- Replace localized rivets with high strength bolts
- Complete recoating of remaining structural steel and steel railing components
- Replace all bearings
- Reface abutment walls, wingwalls, ballast walls and all pier shafts, including bearing seats
- Place rock protection on east embankment in front of abutment
- New bridge and approach lighting
- Replace railings on wingwalls (should be repaired in 2019)

A subsequent minor renewal would be required approximately 15 years after the major rehabilitation, which would include: milling and paving deck and approach wearing surface and replacing expansion joint seals. No further concrete or coating repairs would be carried out as the structure would be left to continue to deteriorate prior to complete replacement in 2048 (25 years after the major rehabilitation). Subsequent minor renewals would be required approximately 15 years after replacement (replacing expansion joint seals), 30 years after replacement (replacing entire joint assembly and concrete patch repairs), and 45 years after replacement (replacing expansion joint seals and concrete patch repairs).

Option 2: Structure Replacement in 2023

Although a detailed study is required to confirm the preferred structure type and location, for cost comparison purposes, this option is assumed to involve replacing the existing structure in 2023 with a 160m 4-span bridge consisting of a concrete slab-on-steel girders, similar to the recent Adàwe Crossing - Rideau River Multi-Use Pathway Bridge (SN018570). The steel girders are assumed to be fabricated from weathering (ACR) steel to eliminate future re-coating maintenance costs. The deck cross section would consist of a 4.5m wide structure with a 4m clear width (as requested by the City’s Transportation Planning staff during correspondences for this renewal options study). The structure is assumed to have continuous spans at the piers in order to minimize the need for future expansion joint replacement/maintenance costs and minimize deterioration to the adjacent structural components at these locations. The new concrete deck would be left exposed (i.e. no asphalt wearing surface) like the Adàwe Crossing and Corktown Footbridge (SN018560), permitting easy winter maintenance.

It is also assumed that the replacement bridge would be located on a new alignment 10m upstream (south) of the existing structure alignment (instead of on the same alignment) for cost comparison purposes. As such, the existing bridge could be kept in service until the new bridge is constructed, reducing traffic detour costs/disruption to public or eliminating the costs of a temporary bridge during construction. The City’s Transportation Planning staff have indicated that if structure replacement is considered, from a cycling network perspective, the preferred location of the new structure would be approximately 100m upstream of the existing bridge (i.e. major desire line for this area), which is the most direct alignment for someone on the LRT pathway travelling over Riverside Drive to the Downtown. However, this desired location, along with other design requirements and site constraints, should be considered as part of a future detailed study of the structure replacement. The existing structure would be demolished after placing the new bridge in service, including removing the existing stone masonry/concrete abutments and piers down to the riverbed.

This renewal option would provide a new structure with a 75-year design life in accordance with the CHBDC, with interim rehabilitation and maintenance work.

Subsequent minor renewals would be required approximately 15 years after replacement (replacing expansion joint seals), 30 years after replacement (replacing entire joint assembly and concrete patch repairs), 50 years (replacing bearings, replacing expansion joint seals and concrete patch repairs), and 65 years (replacing entire expansion joint assemblies and concrete patch repairs).

5.2 Environmental Permit and Approval Requirements

In accordance with the Ontario Municipal Class EA requirements, projects that involve “*reconstruction of a water crossing where the reconstructed facility will be for the same purpose, use, capacity and at the same location (capacity refers to either hydraulic or road capacity but does not include alterations to include or remove facilities for cycling, pedestrians or to support utilities) this includes ferry docks*”, such as the major rehabilitation (Option 1) of the bridge, are considered Schedule A+ pre-approved projects. In accordance with the Ontario Municipal Class EA requirements (2015 Amendments), projects that involve “*construction or removal of sidewalks, multi-purpose paths or cycling facilities including water crossings outside existing right-of-way*”, such as the bridge replacement (Option 2) with a project value of \$3.5M - \$9.5M, are considered Schedule B projects.

This project (Option 1 or Option 2) will involve construction work at the east abutment and approach on adjacent National Capital Commission (NCC) land on the east shore of the Rideau River, which will require Federal Land Use, Design and transaction Approval (FLUDA). In accordance with the *National Capital Act*, projects on NCC lands that are initiated by other parties require an Environmental Effects Evaluation in order to allow the NCC to meet its legal obligations under the *Canadian Environmental Assessment Act, 2012*. In addition, access to the site on the east shore by the Contractor will be required across NCC land, which will require a Land Access Permit.

This site is located within the jurisdiction of the Rideau Valley Conservation Authority (RVCA). Based on our preliminary consultation with the RVCA, a “Development, Interference with Wetlands, Alteration to Shorelines and Watercourses” permit will need to be obtained from the Conservation Authority prior to commencement of the work, in accordance with Section 28 of the *Conservation Authorities Act* and Ontario Regulation 174/06.

In the spring of 2016, the Ministry of the Environment, Conservation and Parks (MOECP) (formerly Ministry of the Environment and Climate Change) enacted regulatory changes to the Permit to Take Water (PTTW) process. Dewatering/temporary flow diversion activities (i.e. construction activities occurring within or partially within a waterbody and water being pumped to create and maintain a dewatered work area) are now exempt from Section 34 of the Ontario Water Resources Act (Option 1 and Option 2), if prescribed discharge measures are implemented as per O. Reg. 387/04. However, any construction site dewatering (i.e. ground water and/or storm water) Environmental Activity and Sector Registry (EASR) or a PTTW (Option 2 only), depending on the water taking volume. The requirements for EASR, PTTW or exemption of these requirements will need to be confirmed during the design phase once the exact water taking activities are confirmed.

The Ministry of Natural Resources and Forestry (MNRF) was contacted to identify any potential natural heritage values, Species at Risk (SAR), and in-water work restrictions. After a preliminary review of the project area, the MNRF identified several Fish Nursery Areas (i.e. Black Crappie, Muskellunge, Rock Bass, Smallmouth Bass and Walleye) and an Unevaluated Wetland (not evaluated per the Ontario Wetland Evaluation System) in the general subject area. The MNRF also identified that the site contains significant woodlands and wildlife habitat, and that the lands should be assessed for the risk of wildland fire. The in-water work timing restriction for construction activities in the Rideau River is now from January 1st to June 30th of a given year to allow for winter and spring fish spawning, which will apply for Option 1 and Option 2. A “Works within a Waterbody”

permit under the *Public Lands Act* is required from the MNRF for the proposed works on the bed of the watercourse (i.e. Rideau River), as they will impact Crown lands (Option 1 and Option 2).

The MNRF identified a potential for the following Species at Risk (SAR), Threatened (THR) and/or Endangered (END), on or in proximity to the site: Bank Swallow (THR), Barn Swallow (THR), Blanding's Turtle (THR), Bobolink (THR), Butternut (END), Chimney Swift (THR), Eastern Meadowlark (THR), Eastern Small-footed Myotis (END), Little Brown Bat (END), Northern Long-eared Bat (END), and Tri-Colored Bat (END). The MNRF also identified a potential for the following species of Special Concern (SC) to occur either on the site or nearby: Eastern Wood-Pewee (SC), Peregrine Falcon (SC), Snapping Turtle (SC), Wood Thrush (SC), Monarch (SC), and Northern Map Turtle (SC). Though species of Special Concern are not protected under the *Endangered Species Act (ESA)*, 2007, some of these species may be protected under the *Fish and Wildlife Conservation Act* and/or *Migratory Birds Convention Act*. Also, the habitat of special concern species may be significant wildlife habitat and should be assessed accordingly.

The proposed in-water construction works have the potential to impact fish and fish habitat. In accordance with the *Fisheries Act*, the project should be evaluated during the design phase through the Department of Fisheries and Oceans (DFO) Self-Assessment process to determine if a DFO Request for Review is required.

Navigation Protection Act (NPA) authorization will be required as the Rideau River is listed as a Scheduled Water under the NPA and construction activities and equipment will partially block the river channel (Option 1 and Option 2). As such, a Notice of Works is required to be sent to Transport Canada.

All correspondences with the stakeholders are included in Appendix G.

5.3 Construction Staging and Traffic Management

The major rehabilitation (Option 1) would require full closure of the bridge to pedestrians and cyclists throughout the duration of construction, as the bridge deck requires removal in order to carry out the structural steel repairs and structural steel recoating below deck level. Viable detour routes exist via other existing multi-use crossings of Rideau River, including the OLRT Confederation Line Bridge north of Hurdman Station 500m upstream (i.e. west) of the Old Railway Rideau River Pedestrian Bridge and the Adàwe Crossing 1.3 km downstream (i.e. north). Alternatively, a temporary bridge could be installed throughout construction.

Structure replacement on the same alignment would require full closure of the bridge to pedestrians and cyclists throughout the duration of construction with the same available detours as noted above for the major rehabilitation, or installation of a temporary bridge throughout construction. However, structure replacement on a new alignment just upstream of the existing bridge (Option 2) would allow pedestrians and cyclists to continue to use the existing structure without significant disruption until the new bridge is constructed and placed in service, and the existing bridge is then demolished.

Marine traffic would have to be maintained on the Rideau River throughout construction; a navigation clearance envelope would have to be identified and maintained through the construction site. Cautionary buoys and warning signs would also have to be installed upstream and downstream of the construction site.

5.4 Construction Duration

The anticipated construction duration for each renewal option (Option 1 and Option 2) is 52–60 weeks, based on the proposed scope of works identified above, including full bridge closure with pedestrian and cycling detour (Option 1) and structure replacement on a new alignment (Option 2). The timelines indicated above are based on Parsons' recent experience on similar rehabilitation/replacement projects, but are entirely dependent on the contractor's capabilities, scheduling and selected sequencing of the work, and work force provided.

5.5 Financial Analysis

A Level 2 life cycle cost analysis was undertaken for each renewal option in accordance with the current MTO Structural Financial Analysis Manual (SFAM), in order to determine the preferred renewal strategy for the structure over a period of 75 years, which is also the expected service life of a replacement structure. The residual value for the second cycle structure replacement of each renewal option and for each discount rate was included. The effective discount rate used for the financial analysis was 3% with a sensitivity analysis of life cycle cost using discount rates of 5% and 7%.

The ‘Class C’ construction cost estimates for the Major Rehabilitation in 2023 (Option 1) is \$11,84M and Structure Replacement in 2023 (Option 2) is \$9,86M. The construction cost estimates of the renewal options are based on local supplier prices (provided or published) for the fabrication and delivery of components, City of Ottawa unit prices, and Parsons’ previous tendered projects, and represent our opinion of probable costs for the proposed works. The costs are in 2018 dollars and include allowances for contingencies (25%) and engineering fees (20%), engineering services during construction, and construction administration services, but do not include HST.

The detailed financial life cycle cost analysis of the two (2) renewal options considered is included in Appendix H. A summary of the financial analysis is presented in Table 2 below.

Table 2: Summary of Financial Life Cycle Cost Analysis

Option		Initial Cost	Net Present Value (by Discount Rate)		
No.	Description		3%	5%	7%
1	Major Rehabilitation in 2023	\$11,84M (20%)	\$14,37M (66%)	\$11,60M (49%)	\$9,76M (38%)
2	Structure Replacement in 2023	\$9,86M (-)	\$8,65M (-)	\$7,79M (-)	\$7,06M (-)

Notes:

1. % = Cost difference from least expensive option.
2. Initial costs are in 2018 dollars and include engineering design, construction costs, engineering services during construction, and construction administration services, but exclude HST.

The financial analysis results show that Option 2 has the lower initial capital cost and the lower net present value of both renewal options for all three discount rates (Option 1 is 66% higher for a 3% discount rate). The major rehabilitation (Option 1) has a higher initial capital cost than the structure replacement (Option 2) mainly due to the significant cost of repairing the deteriorated structural steel, structural steel coating system and concrete substructure, which requires costly access to the work areas (including a full enclosure for environmental protection), more costly cofferdams/dewatering due to the additional in-water piers, and replacement of the existing timber deck system required to complete the structural steel repairs and structural steel recoating.

6. RECOMMENDATIONS

One (1) rehabilitation option and one (1) replacement option were developed for the renewal of the Old Railway Rideau River Pedestrian Bridge, taking into account the findings of the Detailed Condition Assessment of the structure and correspondences with stakeholders.

Based on the results of the foregoing renewal options analysis, it is recommended that **Option 2 – Structure Replacement in 2023** be selected as the preferred renewal strategy for the structure. However, based on the existing condition of the structure (i.e. mainly the structural steel bracing below deck), if capital funding is available earlier, it is recommended that the structure replacement be started earlier so that the replacement bridge is completed, and the existing bridge taken out of service by the end of the 1 to 5-year timeframe (i.e. 2019 – 2023). A preliminary general arrangement drawing of the recommended renewal option is included in Appendix I.

The life cycle cost analysis demonstrated that Option 2 requires a lower initial capital investment and the net present value of Option 2 is lower than Option 1 for all three discount rates. As noted in Section 5.1, the existing bridge is 120 years old and has therefore long since exceeded its expected service life. Given the current condition of the structure, if a major rehabilitation is carried out and with regular maintenance, the bridge could remain in service until 2048 (i.e. approx. 30 years), at which time it would be replaced, but the existing configuration and detailing of the bridge require higher future maintenance costs.

The construction cost for the recommended renewal option (Option 2) is **\$9,86M** (in 2018 dollars), including a 25% contingency allowance and 20% for engineering costs, engineering services during construction and construction administration services, but excluding HST.

It is recommended that the structure replacement be completed on a new alignment upstream of the existing bridge, which would allow pedestrians and cyclists to continue using the existing structure without significant disruption until the new bridge is constructed and placed in service, and the existing bridge is then demolished. The construction is expected to be completed in 52 to 60 weeks, depending on contractor capabilities, scheduling and selected sequencing of the work, and work force provided.

Although the approach railing replacement was included in the scope of work and costing for each renewal option in 2023 for simplicity of evaluating the renewal options, this work should be completed in 2019, as the extensive deterioration of the railing posts poses a potential safety concern for pedestrians.

The following maintenance work is also recommended to be completed:

- Rout and seal cracks and patch any potholes in bridge deck asphalt wearing surface
- Install bollard on the east approach
- Replace damaged timber curbs at ends of bridge
- Remove graffiti on the abutments, piers and on the exterior of the north girder at the west abutment
- Clean debris on abutment and pier bearing seats

7. CLOSURE

We trust that this report is adequate for your present requirements. If you have any comments or questions, please contact the undersigned.

Yours truly,

PARSONS INC.



Prepared By:
Jared Struthers
Structural Technologist

Prepared and Reviewed by:
Patrick Mergel, M.Eng., P.Eng., ing.
Senior Structural Engineer

APPENDIX A

OSIM Inspection Forms

OSIM Inspection Form



SECTION A: GENERAL DATA

Final or Draft Copy? **FINAL** Structure Number: 18600 Asset: 4888423
 Contractor ID: 313332 Work Order: 11316542

Inventory Data:



Structure Name: 018600, Old Railway Rideau River Ped Bridge
 Year Built: 1906
 Last Rehab Year: 1999
 Location: Over Rideau River, RF ConD LotG/RF ConJG Lot11
 Road Name: HIGHWAY 417
 Intersections:
 Municipality: OO
 Ward: 17

 Y Latitude: 5031052.656 X Longitude: 370318.277

 Total Width: 4.00
 Total Span Length: 159.4
 Total Span Area: 637.6
 Structure Type: GIRDER
 Structure Material: STEEL
 Number of Spans: 8
 Orientation: EAST_WEST
 New Angle in degrees:

Overall Structure Inspection Notes

Inspection Type: ENHANCED
 Date of Inspection (YYYY-MM-DD): 2018-06-11
 Inspector: Patrick Mergel, P.Eng., Mina Sedarous P.Eng.
 Other Inspector: Jared Struthers, Tech., Janna Golzari, E.I.T., Amer Hammoud, E.I.T.
 Access Equipment: Platform with scaffolding
 Recommended Work Type: MAJOR REHAB
 Recommended Work Timing: 1-5 YEAR

 Significant Findings: Very severe corrosion and perforations in multiple members and connections for all lateral braces and cross-frames, including numerous completely detached members. Medium to severe corrosion on all bearings. Widespread coating failure on all steel below deck. Very severe disintegration with exposed rebar at east abutment and most piers. Debonded and/or leaking compression joint seals. Water penetration through the timber deck. Significant section loss at based of approach railing posts (Potential Safety Concern).

Additional Investigation Notes

Concrete Substructure Condition Survey:
 Detailed Coating Condition Survey:
 Detailed Deck Condition Survey:
 Detailed Timber Investigation:
 Fatigue Investigation:
 Monitoring Crack Widths:
 Monitoring of Deformations, Settlements and Movements:
 Non-Destructive Delamination Survey of Asphalt-Covered Deck:
 Seismic Investigation:
 Structure Evaluation: NORMAL
 Underwater Investigation:
 Post-Tensioned Strand Investigation:

 Investigation Notes: A structure evaluation is recommended to determine the effect of the very severely deteriorated cross-frames and lateral braces on the capacity of the structure to resist lateral forces.

Element: 018600, ABUTMENT, ABUTM			
Work Order	11316547	Recommended	Maintenance
Asset Number	4919191	Work	Need
Element Group	ABUTMENTS	MAJOR REHAB	2-Bridge Cleaning
Element Name	ABUTMENT WALLS	1-5 YEAR	2-YEAR
Environment	MODERATE		
Limited Insp.	NO		
Protection System	None		
Units of Measure	Sq.m.	Description	Description
Qty. In Excellent Condition		Extensive concrete repairs, mainly on east abutment	Remove graffiti on both walls
Qty. In Good Condition	9.48		
Qty. In Fair Condition	23.90		
Qty. In Poor Condition	16.50		
Total Quantity	49.88		
		Comments	Element Specifications
		Severe to very severe delaminations on the east abutment wall (5). Severe to very severe disintegration up to 150 mm deep with exposed corroded rebar throughout the east abutment wall, east bearing seat, east footing, and west abutment wall (11.5). Medium crack on the east bearing seat (0.4). Medium AAR throughout the east abutment wall (7). Accumulation of debris on both bearing seats limiting visual inspection. Non-offensive graffiti both abutment walls.	Location East and West Ends Type Closed Abutment Material CONC_CIP Length 0.00 Width 5.80 Height 4.30 Count 2

Please do not change dimensions if the difference is < 2%

Element: 018600, ACCESSORY, ACCESSORIES (ATTACHMENTS AND SIGNS), OTHER			
Work Order	11316561	Recommended	Maintenance
Asset Number	4923166	Work	Need
Element Group	ACCESSORIES (ATTACHME	18-Other	1-YEAR
Element Name	OTHER		
Environment	SEVERE		
Limited Insp.	NO		
Protection System	Paint Coating		
Units of Measure	Each	Description	Description
Qty. In Excellent Condition			
Qty. In Good Condition	1.00	Replace missing bollard on east approach (incorrectly identified in 2016 OSIM report)	
Qty. In Fair Condition			
Qty. In Poor Condition	1.00		
Total Quantity	2.00		
		Comments	Element Specifications
		Non-offensive graffiti on west bollard. East bollard missing (incorrectly identified in 2016 OSIM report).	Location At End Type Steel Bollards Material STEEL Length 0.00 Width 0.00 Height 0.00 Count 2.00

Please do not change dimensions if the difference is < 2%

Element: 018600, APPROACH BARRIER, APPROACHES, BARRIERS			
Work Order	11316566	Recommended	Maintenance
Asset Number	4923170	Work	Need
Element Group	APPROACHES	REPLACE	0-1 YEAR
Element Name	BARRIERS		
Environment	SEVERE		
Limited Insp.	NO		
Protection System	Painted Coating		
Units of Measure	m.	Description	Description
Qty. In Excellent Condition		Replace railings both approaches	Capacity of railing to resist pedestrian loading highly questionable due to extensive corrosion at base of posts.
Qty. In Good Condition			
Qty. In Fair Condition	6.80		
Qty. In Poor Condition	10.00		
Total Quantity	16.80		
		Comments	Element Specifications
		Medium to very severe corrosion at base of posts with up to 75% section loss (14). Localized light corrosion typical throughout hand railings and posts.	Location East and West Wingwalls Type Steel Pipe Hand Railing Material STEEL Length 4.20 Width 0.00 Height 0.00 Count 4

Please do not change dimensions if the difference is < 2%

Element: 018600, APPROACH SURFACE, APPROACHES, WEARING SURFACE		Recommended Timing		Maintenance Need		Deficiencies	
Work	Timing	Need	Timing	Performance	Material		
MAJOR REHAB	1-5 YEAR					27-Ravelling	25-Pattern Cracks
Description		Description		Description			
Comments		Element Specifications					
Severe ravelling along interface with steel joint armouring plates (0.1). Localized medium ravelling (7). Light ravelling typical throughout. Light edge cracking on east approach.		Location		East and West Ends Between Wingwalls			
		Type					
		Material		ASPHALT			
		Length		6.00			
		Width		2.85			
		Height		0.00			
		Count		2			
<i>Please do not change dimensions if the difference is < 2%</i>							

Element: 018600, BALLAST WALL, ABUTMENTS, BALLAST WALLS		Recommended Timing		Maintenance Need		Deficiencies	
Work	Timing	Need	Timing	Performance	Material		
MAJOR REHAB	1-5 YEAR					12-Disintegration	6-Corrosion
Description		Description		Description			
Comments		Element Specifications					
Very severe disintegration up to 150 mm deep with exposed corroded rebar on both ballast walls (3). Severe delaminations on both ballast walls (0.4). Wide horizontal crack on east ballast wall (0.4). Localized medium aggregate alkali reaction on both ballast walls (4.8). Narrow to medium (0.2) vertical crack on east ballast wall.		Location		East and West Abutments			
		Type					
		Material		CONC_CIP			
		Length		0.00			
		Width		5.80			
		Height		1.22			
		Count		2			
<i>Please do not change dimensions if the difference is < 2%</i>							

Element: 018600, BEAM/MLE, BEAMS/MAIN LONGITUDINAL ELEMENTS, GIRDERS		Recommended Timing		Maintenance Need		Deficiencies	
Work	Timing	Need	Timing	Performance	Material		
MAJOR REHAB	6-10 YEAR					6-Corrosion	
Description		Description		Description			
Comments		Element Specifications					
Medium (64) to very severe (62.5) corrosion of interior bottom flange, interior bottom angles, interior stiffeners, interior web, rivet heads and shelf angles. Localized rust jacking at top flange (1). Light to medium (13) corrosion at asphalt interface, interior diaphragms, top flange and exterior top of bottom flange. Limited inspection as interior web of girders on each side hidden by timber ledgers, laminated timber deck and asphalt wearing surface.		Location		Middle			
		Type		Riveted Built-Up Plate I-Girder			
		Material		STEEL			
		Length		128.00			
		Width		0.38			
		Height		1.93			
		Count		2			
<i>Please do not change dimensions if the difference is < 2%</i>							

Element: 018600, BEAM/MLE, BEAMS/MAIN LONGITUDINAL ELEMENTS, GIRDERS									
Work Order	11316559	Recommended		Maintenance		Deficiencies			
Asset Number	4923165	Work	Timing	Need	Timing	Performance		Material	
Element Group	BEAMS/MAIN LONGITUDINAL	MAJOR REHAB	6-10 YEAR	2-Bridge Cleaning	2-YEAR			6-Corrosion	
Element Name	GIRDERS							4-Collision damage	
Environment	SEVERE							9-Deformation	
Limited Insp.	YES								
Protection System	Paint Coating								
Units of Measure	Sq.m.	Description		Description		Description			
Qty. In Excellent Condition		Repairs to horizontal shelf angles, vertical stiffeners, and localized rivets		Remove graffiti at N/W					
Qty. In Good Condition	259.62								
Qty. In Fair Condition	60.10								
Qty. In Poor Condition	24.60								
Total Quantity	344.32								
Comments					Element Specifications				
Impact damage and crack in top flange on southwest (0.3). Deformation of bottom flange at the southeast bearing of pier 7 (0.3). Medium (32) to severe (24) corrosion of interior bottom flange, stiffeners, interior bottom angles, rivet heads, web and shelf angles. Rust jacking at top flange (0.5). Light to medium (3) corrosion at asphalt interface and at interior diaphragms, top flange, and exterior top of bottom flange. Limited inspection as interior web of girders on each side hidden by timber ledgers, laminated timber deck and asphalt wearing surface. Graffiti on exterior of north girder at west abutment.					Location	Ends			
					Type	Riveted Built-Up Plate I-Girder			
					Material	STEEL			
					Length	2.00			
					Width	0.38			
					Height	1.93			
					Count	32			
<i>Please do not change dimensions if the difference is < 2%</i>									

Element: 018600, BEAM/MLE, COATINGS, STRUCTURAL STEEL									
Work Order	11316563	Recommended		Maintenance		Deficiencies			
Asset Number	4923167	Work	Timing	Need	Timing	Performance		Material	
Element Group	COATINGS	REPLACE	1-5 YEAR			16-Other		15-Flaking Paint	
Element Name	STRUCTURAL STEEL							6-Corrosion	
Environment	SEVERE								
Limited Insp.	YES								
Protection System	None								
Units of Measure	Sq.m.	Description		Description		Description			
Qty. In Excellent Condition		Recoat below deck. Localized coating repairs above deck.				Coating below deck no longer protecting structural steel members against corrosion.			
Qty. In Good Condition	956.23								
Qty. In Fair Condition	18.00								
Qty. In Poor Condition	403.00								
Total Quantity	1377.23								
Comments					Element Specifications				
Flaking paint, peeling paint and coating loss on bottom flange and interior web beneath superstructure (402), and on exterior web (1). Localized medium rust staining on top flange, asphalt interface and exterior rivets (18). Limited inspection as interior web of girders on each side hidden by timber ledgers, laminated timber deck and asphalt wearing surface.					Location	Girder Middle			
					Type	Alkyd Coating System			
					Material	PAINT_COATING			
					Length	128.00			
					Width	0.38			
					Height	1.93			
					Count	2			
<i>Please do not change dimensions if the difference is < 2%</i>									

Element: 018600, BEAM/MLE, COATINGS, STRUCTURAL STEEL									
Work Order	11316562	Recommended		Maintenance		Deficiencies			
Asset Number	4923167	Work	Timing	Need	Timing	Performance		Material	
Element Group	COATINGS	REPLACE	1-5 YEAR			16-Other		15-Flaking Paint	
Element Name	STRUCTURAL STEEL							6-Corrosion	
Environment	SEVERE								
Limited Insp.	YES								
Protection System	None								
Units of Measure	Sq.m.	Description		Description		Description			
Qty. In Excellent Condition		Recoat below deck. Localized coating repairs above deck.				Coating below deck no longer protecting structural steel members against corrosion.			
Qty. In Good Condition	239.82								
Qty. In Fair Condition	4.00								
Qty. In Poor Condition	100.50								
Total Quantity	344.32								
Comments					Element Specifications				
Flaking paint, peeling paint, and coating loss on bottom flange and interior web beneath superstructure (100), and on exterior web (0.5). Localized medium rust staining and deterioration of paint on top flange, exterior rivets, and asphalt interface (4). Limited inspection as interior web of girders on each side hidden by timber ledgers, laminated timber deck and asphalt wearing surface.					Location	Girders Ends			
					Type	Alkyd Coating System			
					Material	PAINT_COATING			
					Length	2.00			
					Width	0.38			
					Height	1.93			
					Count	32			
<i>Please do not change dimensions if the difference is < 2%</i>									

Element: 018600, BEARING, ABUTMENTS, BEARINGS									
Work Order 11316558		Recommended		Maintenance		Deficiencies			
Asset Number 4921885		Work	Timing	Need	Timing	Performance		Material	
Element Group ABUTMENTS		REPLACE	1-5 YEAR	6-Bridge Bearing Maintenance	1-YEAR	5-Seized Bearings		6-Corrosion	
Element Name BEARINGS									
Environment MODERATE									
Limited Insp. NO									
Protection System Paint Coating									
Units of Measure Each		Description		Description		Description			
Qty. In Excellent Condition		Replace bearings		Flush debris from bearings		Suspected impedance of movement due to corrosion and accumulation of debris.			
Qty. In Good Condition									
Qty. In Fair Condition 2.00									
Qty. In Poor Condition 2.00									
Total Quantity 4.00									
Comments					Element Specifications				
Light to severe corrosion on all bearings. Accumulation of debris on bearings. Coating failure typical on all bearings. Expansion bearings are on the east abutment, fixed bearings are on the west abutment.					Location	East and West Abutments			
					Type	Spherical Disc and Plate			
					Material	STEEL_PLAT			
					Length	0.00			
					Width	0.00			
					Height	0.00			
Count	4								
<i>Please do not change dimensions if the difference is < 2%</i>									

Element: 018600, BEARING, PIERS, BEARINGS									
Work Order 11316557		Recommended		Maintenance		Deficiencies			
Asset Number 4921884		Work	Timing	Need	Timing	Performance		Material	
Element Group PIERS		REPLACE	1-5 YEAR	6-Bridge Bearing Maintenance	1-YEAR	5-Seized Bearings		6-Corrosion	
Element Name BEARINGS						5-Bearing not uniformly loaded/unstable		7-Cracks	
Environment MODERATE								5-Connection Deficiencies	
Limited Insp. NO									
Protection System Paint Coating									
Units of Measure Each		Description		Description		Description			
Qty. In Excellent Condition		Replace bearings		Flush debris from bearings		Suspected impedance of movement due to corrosion and accumulation of debris. Pier 7 southeast bearing is suspected to be not uniformly loaded. Anchor bolt sheared off at northwest pier 4 expansion bearing.			
Qty. In Good Condition									
Qty. In Fair Condition 11.00									
Qty. In Poor Condition 17.00									
Total Quantity 28.00									
Comments					Element Specifications				
Cracked steel casing of southeast bearing on pier 7; it has been temporarily repaired with a clamping device. Light to very severe corrosion on all bearings. Accumulation of debris typical on and inside bearings. Coating failure typical on all bearings. Expansion bearings are on the west side of piers, fixed bearings are on the east side of piers. Spalling and disintegration observed on multiple bearing seats. Anchor bolt sheared off at pier 4 northwest expansion bearing.					Location	All Piers			
					Type	Spherical Disc and Plate			
					Material	STEEL_PLAT			
					Length	0.00			
					Width	0.00			
					Height	0.00			
Count	28								
<i>Please do not change dimensions if the difference is < 2%</i>									

Element: 018600, DECK DRAIN SYSTEM, DECKS, DRAINAGE SYSTEM									
Work Order 11316548		Recommended		Maintenance		Deficiencies			
Asset Number 4920536		Work	Timing	Need	Timing	Performance		Material	
Element Group DECKS								6-Corrosion	
Element Name DRAINAGE SYSTEM									
Environment SEVERE									
Limited Insp. NO									
Protection System Galvanized Coating									
Units of Measure Each		Description		Description		Description			
Qty. In Excellent Condition									
Qty. In Good Condition 24.00									
Qty. In Fair Condition									
Qty. In Poor Condition									
Total Quantity 24.00									
Comments					Element Specifications				
Localized light corrosion on downspouts.					Location	Along North Timber Curbs			
					Type	Deck Drain Grating and Downspout			
					Material	STEEL			
					Length	0.00			
					Width	0.00			
					Height	0.00			
Count	24								
<i>Please do not change dimensions if the difference is < 2%</i>									

Element: 018600, DECK DRAIN SYSTEM, DECKS, DRAINAGE SYSTEM		Recommended		Maintenance		Deficiencies	
Work	Timing	Need	Timing	Performance	Material		
MAJOR REHAB	6-10 YEAR	16-Bridge Deck Drainage	1-YEAR	11-Deck drainage	24-Other		
Work Order 11316549 Asset Number 4920536 Element Group DECKS Element Name DRAINAGE SYSTEM Environment SEVERE Limited Insp. NO Protection System None							
Units of Measure Each Qty. In Excellent Condition Qty. In Good Condition 160.00 Qty. In Fair Condition Qty. In Poor Condition Total Quantity 160.00		Description Extend Drainage Outlets Below Girders		Description Remove debris from southeast rectangular deck drain.		Description Lack of downspouts on ends of drains is exposing structural steel to water and road salt.	
		Comments Splintered wood lodged in southeast deck drain.		Element Specifications Location Along Exterior of Timber Curbs Type Deck Drainage Rectangular Openings Through Timber Deck Material UNKNOWN Length 0.38 Width 0.10 Height 0.00 Count 160			
<i>Please do not change dimensions if the difference is < 2%</i>							

Element: 018600, DECK WEARING SURFACE, DECKS, WEARING SURFACE		Recommended		Maintenance		Deficiencies	
Work	Timing	Need	Timing	Performance	Material		
		15-Route and Seal	1-YEAR		27-Ravelling 7-Cracks 26-Potholes 25-Pattern Cracks		
Work Order 11316572 Asset Number 4925721 Element Group DECKS Element Name WEARING SURFACE Environment SEVERE Limited Insp. NO Protection System None							
Units of Measure Sq.m. Qty. In Excellent Condition Qty. In Good Condition 559.00 Qty. In Fair Condition 41.00 Qty. In Poor Condition 24.00 Total Quantity 624.00		Description Rout and seal cracks in deck wearing surface					
		Comments Breakup, potholes and ravelling of asphalt around deck expansion joints (3). Light, medium (20) and severe (13) isolated unsealed transverse cracks full width of deck and severe progressive edge cracking (5). Localized areas of light to severe (3) ravelling typical throughout.		Element Specifications Location Top of Laminated Timber Deck Type Material ASPHALT Length 160.00 Width 3.90 Height 0.00 Count 1			
<i>Please do not change dimensions if the difference is < 2%</i>							

Element: 018600, DECK, DECKS, DECK TOP		Recommended		Maintenance		Deficiencies	
Work	Timing	Need	Timing	Performance	Material		
Work Order 11316544 Asset Number 4917845 Element Group DECKS Element Name DECK TOP Environment MODERATE Limited Insp. YES Protection System Asphalt and Waterproofing							
Units of Measure Sq.m. Qty. In Excellent Condition Qty. In Good Condition 603.00 Qty. In Fair Condition 13.00 Qty. In Poor Condition 8.00 Total Quantity 624.00							
		Comments Rating based on top-down/bottom-up defects in asphalt		Element Specifications Location Between Girders Type Laminated Timber Deck Material WOOD Length 160.00 Width 3.90 Height 0.00 Count 1			
<i>Please do not change dimensions if the difference is < 2%</i>							

Element: 018600, DECK, DECKS, SOFFIT		Recommended Timing		Maintenance Need		Deficiencies	
		Work	Timing	Need	Timing	Performance	Material
Work Order	11316546						
Asset Number	4917846						
Element Group	DECKS						3-Checks,Splits, shakes
Element Name	SOFFIT						18-Joint leakage with active wet area
Environment	MODERATE						
Limited Insp.	NO						
Protection System	None						
Units of Measure	Sq.m.						
Qty. In Excellent Condition							
Qty. In Good Condition	444.30						
Qty. In Fair Condition	49.90						
Qty. In Poor Condition	5.00						
Total Quantity	499.20						
Description		Description		Description		Description	
Comments		Element Specifications					
Medium (5) to severe (5) shakes and splits in timber. Water observed penetrating laminated timber deck. Wet staining observed throughout (44.9). Timber ledger with light shakes and splits.		Location	Interior				
		Type	Laminated Timber Deck				
		Material	WOOD				
		Length	128.00				
		Width	3.90				
		Height	0.00				
Count	1						
<i>Please do not change dimensions if the difference is < 2%</i>							

Element: 018600, DECK, DECKS, SOFFIT		Recommended Timing		Maintenance Need		Deficiencies	
		Work	Timing	Need	Timing	Performance	Material
Work Order	11316545						
Asset Number	4917846						
Element Group	DECKS						18-Joint leakage with active wet area
Element Name	SOFFIT						3-Checks,Splits, shakes
Environment	MODERATE						
Limited Insp.	NO						
Protection System	None						
Units of Measure	Sq.m.						
Qty. In Excellent Condition							
Qty. In Good Condition	111.30						
Qty. In Fair Condition	12.50						
Qty. In Poor Condition	1.00						
Total Quantity	124.80						
Description		Description		Description		Description	
Comments		Element Specifications					
Medium (3) to severe (1) shakes and splits in timber. Water observed penetrating laminated timber deck. Wet staining observed throughout (9.5). Timber ledger with several light shakes and splits.		Location	End				
		Type	Laminated Timber Deck				
		Material	WOOD				
		Length	2.00				
		Width	3.90				
		Height	0.00				
Count	16						
<i>Please do not change dimensions if the difference is < 2%</i>							

Element: 018600, EMBANKMENT, EMBANKMENTS AND STREAMS, EMBANKMENTS		Recommended Timing		Maintenance Need		Deficiencies	
		Work	Timing	Need	Timing	Performance	Material
Work Order	11316574						
Asset Number	4926922						
Element Group	EMBANKMENTS AND STREAMS						
Element Name	EMBANKMENTS						
Environment	BENIGN						
Limited Insp.	NO						
Protection System	Rip-rap						
Units of Measure	Each						
Qty. In Excellent Condition							
Qty. In Good Condition	5.00						
Qty. In Fair Condition	1.00						
Qty. In Poor Condition							
Total Quantity	6.00						
Description		Description		Description		Description	
Comments		Element Specifications					
Foot paths with light erosion on southwest side slope. Southwest, northeast and northwest embankments well vegetated. Embankment in front of the east abutments has erosion of material greater than 10%, likely due to high river flows.		Location	Quadrants				
		Type					
		Material	SOIL				
		Length	0.00				
		Width	0.00				
		Height	0.00				
Count	6						
<i>Please do not change dimensions if the difference is < 2%</i>							

OSIM Inspection

Element Results



Element: 018600, EMBANKMENT, EMBANKMENTS AND STREAMS, SLOPE PROTECTION		Recommended Timing		Maintenance Timing		Deficiencies	
		Work	Timing	Need	Timing	Performance	Material
Work Order	11316579						
Asset Number	5077503						
Element Group	EMBANKMENTS AND STREA						
Element Name	SLOPE PROTECTION						
Environment	BENIGN						
Limited Insp.	NO						
Protection System	None						
Units of Measure	Each						
Qty. In Excellent Condition							
Qty. In Good Condition	2.00						
Qty. In Fair Condition							
Qty. In Poor Condition							
Total Quantity	2.00						
Description		Description		Description		Description	
Comments		Element Specifications					
Rip-rap on northwest embankment and west embankment in front of asphalt pathway.		Location	NW and in front of abutment at west				
		Type	Rip-Rap				
		Material	STONE				
		Length	0.00				
		Width	0.00				
		Height	0.00				
Count	2						
<i>Please do not change dimensions if the difference is < 2%</i>							

Element: 018600, EXPANSION JOINT, JOINTS-TRANSVERSE, ARMOURING/RETAINING DEVICES		Recommended Timing		Maintenance Timing		Deficiencies	
		Work	Timing	Need	Timing	Performance	Material
Work Order	11316570						
Asset Number	4925719						
Element Group	JOINTS-TRANSVERSE						
Element Name	ARMOURING/RETAINING DE						
Environment	SEVERE						
Limited Insp.	NO						
Protection System	None						
Units of Measure	m.						
Qty. In Excellent Condition							
Qty. In Good Condition	64.20						
Qty. In Fair Condition	3.00						
Qty. In Poor Condition	3.00						
Total Quantity	70.20						
Description		Description		Description		Description	
Comments		Element Specifications					
Damage to first interior joint from east (3). Localized light corrosion on the steel armouring plates. Light to medium corrosion on the steel armouring angle bolts beneath the deck.		Location	Between Spans at Abutments and Piers				
		Type	Rolled Angle Sections				
		Material	STEEL_PLAT				
		Length	0.00				
		Width	3.90				
		Height	0.00				
Count	18						
<i>Please do not change dimensions if the difference is < 2%</i>							

Element: 018600, EXPANSION JOINT, JOINTS-TRANSVERSE, SEALS/SEALANTS		Recommended Timing		Maintenance Timing		Deficiencies	
		Work	Timing	Need	Timing	Performance	Material
Work Order	11316569						
Asset Number	4925718						
Element Group	JOINTS-TRANSVERSE						
Element Name	SEALS/SEALANTS						
Environment	SEVERE						
Limited Insp.	NO						
Protection System	None						
Units of Measure	Each						
Qty. In Excellent Condition							
Qty. In Good Condition	6.00						
Qty. In Fair Condition							
Qty. In Poor Condition	3.00						
Total Quantity	9.00						
Description		Description		Description		Description	
MAJOR REHAB		1-5 YEAR				16-Other	
Replace all joint seals						18-Joint leakage with active wet area	
Comments		Element Specifications					
Compression seal damaged and sagging at the west abutment, pier 2, and pier 4. Other seals are in good condition with regards to material, but leakage is suspected at joints.		Location	Between Spans at Abutments and Piers				
		Type	Compression Seal				
		Material	NEOPRENE				
		Length	0.00				
		Width	3.90				
		Height	0.00				
Count	9						
<i>Please do not change dimensions if the difference is < 2%</i>							

Element: 018600, FLOOR BEAM, BEAMS/MAIN LONGITUDINAL ELEMENTS, DIAPHRAGMS																																											
Work Order	11316555	<table border="1"> <thead> <tr> <th>Recommended Timing</th><th>Maintenance Need</th><th>Deficiencies</th></tr> <tr> <th>Work</th><th>Timing</th><th>Performance</th><th>Material</th></tr> </thead> <tbody> <tr> <td>REPLACE</td><td>1-5 YEAR</td><td>1-Load carrying capacity</td><td>6-Corrosion</td></tr> <tr> <td></td><td></td><td></td><td></td></tr> <tr> <td></td><td></td><td></td><td></td></tr> <tr> <td></td><td></td><td></td><td></td></tr> <tr> <td></td><td></td><td></td><td></td></tr> <tr> <th>Description</th><th>Description</th><th>Description</th></tr> <tr> <td>Replace all pier cross-frames.</td><td></td><td>All pier cross-frames have perforations and/or very severe corrosion (75 to 100% section loss) in multiple members. Resistance to lateral forces reduced due to deterioration.</td></tr> </tbody> </table>	Recommended Timing	Maintenance Need	Deficiencies	Work	Timing	Performance	Material	REPLACE	1-5 YEAR	1-Load carrying capacity	6-Corrosion																	Description	Description	Description	Replace all pier cross-frames.		All pier cross-frames have perforations and/or very severe corrosion (75 to 100% section loss) in multiple members. Resistance to lateral forces reduced due to deterioration.	Asset Number	4921882	Element Group	BEAMS/MAIN LONGITUDINAL	Element Name	DIAPHRAGMS	Environment	MODERATE
Recommended Timing	Maintenance Need		Deficiencies																																								
Work	Timing		Performance	Material																																							
REPLACE	1-5 YEAR		1-Load carrying capacity	6-Corrosion																																							
Description	Description	Description																																									
Replace all pier cross-frames.		All pier cross-frames have perforations and/or very severe corrosion (75 to 100% section loss) in multiple members. Resistance to lateral forces reduced due to deterioration.																																									
Limited Insp.	NO	Protection System	Paint Coating	Units of Measure	Each	Qty. In Excellent Condition		Qty. In Good Condition		Qty. In Fair Condition		Qty. In Poor Condition	14.00	Total Quantity	14.00																												
Comments		Element Specifications		Location	At Piers	Type	Built-Up Cross-Frames of Angle Sections	Material	STEEL	Length	3.90	Width	0.00	Height	0.00	Count	14																										
Severe to very severe corrosion with rust jacking and perforations on vertical gusset plates and top and bottom horizontal braces. Medium to very severe section loss typical in diagonal braces with localized small perforations.				Please do not change dimensions if the difference is < 2%																																							

Element: 018600, FLOOR BEAM, BEAMS/MAIN LONGITUDINAL ELEMENTS, DIAPHRAGMS																																											
Work Order	11316554	<table border="1"> <thead> <tr> <th>Recommended Timing</th><th>Maintenance Need</th><th>Deficiencies</th></tr> <tr> <th>Work</th><th>Timing</th><th>Performance</th><th>Material</th></tr> </thead> <tbody> <tr> <td>REPLACE</td><td>1-5 YEAR</td><td>1-Load carrying capacity</td><td>6-Corrosion</td></tr> <tr> <td></td><td></td><td></td><td>9-Deformation</td></tr> <tr> <td></td><td></td><td></td><td></td></tr> <tr> <td></td><td></td><td></td><td></td></tr> <tr> <td></td><td></td><td></td><td></td></tr> <tr> <th>Description</th><th>Description</th><th>Description</th></tr> <tr> <td>Replace all intermediate cross-frames</td><td></td><td>All intermediate cross-frames have perforations and/or very severe corrosion (75 to 100% section loss) in multiple members. Resistance to lateral forces reduced due to deterioration.</td></tr> </tbody> </table>	Recommended Timing	Maintenance Need	Deficiencies	Work	Timing	Performance	Material	REPLACE	1-5 YEAR	1-Load carrying capacity	6-Corrosion				9-Deformation													Description	Description	Description	Replace all intermediate cross-frames		All intermediate cross-frames have perforations and/or very severe corrosion (75 to 100% section loss) in multiple members. Resistance to lateral forces reduced due to deterioration.	Asset Number	4921882	Element Group	BEAMS/MAIN LONGITUDINAL	Element Name	DIAPHRAGMS	Environment	MODERATE
Recommended Timing	Maintenance Need		Deficiencies																																								
Work	Timing		Performance	Material																																							
REPLACE	1-5 YEAR		1-Load carrying capacity	6-Corrosion																																							
				9-Deformation																																							
Description	Description	Description																																									
Replace all intermediate cross-frames		All intermediate cross-frames have perforations and/or very severe corrosion (75 to 100% section loss) in multiple members. Resistance to lateral forces reduced due to deterioration.																																									
Limited Insp.	NO	Protection System	Paint Coating	Units of Measure	Each	Qty. In Excellent Condition		Qty. In Good Condition		Qty. In Fair Condition	40.00	Qty. In Poor Condition	40.00	Total Quantity	40.00																												
Comments		Element Specifications		Location	Intermediate	Type	Built-Up Cross-Frames of Angle Sections	Material	STEEL	Length	3.90	Width	0.00	Height	0.00	Count	40																										
Severe to very severe corrosion with rust jacking and perforations on vertical gusset plates and top and bottom horizontal braces. Medium to very severe section loss typical in diagonal braces with localized small perforations. Severe deformation of the top brace of the cross-frame 2 bays west of Pier 5.				Please do not change dimensions if the difference is < 2%																																							

Element: 018600, FLOOR BEAM, BEAMS/MAIN LONGITUDINAL ELEMENTS, DIAPHRAGMS																																											
Work Order	11316553	<table border="1"> <thead> <tr> <th>Recommended Timing</th><th>Maintenance Need</th><th>Deficiencies</th></tr> <tr> <th>Work</th><th>Timing</th><th>Performance</th><th>Material</th></tr> </thead> <tbody> <tr> <td>REPLACE</td><td>1-5 YEAR</td><td>1-Load carrying capacity</td><td>6-Corrosion</td></tr> <tr> <td></td><td></td><td></td><td></td></tr> <tr> <td></td><td></td><td></td><td></td></tr> <tr> <td></td><td></td><td></td><td></td></tr> <tr> <td></td><td></td><td></td><td></td></tr> <tr> <th>Description</th><th>Description</th><th>Description</th></tr> <tr> <td>Replace both abutment cross-frames</td><td></td><td>Both abutment cross-frames have perforations and/or very severe corrosion (75 to 100% section loss) in multiple members. Resistance to lateral forces reduced due to deterioration.</td></tr> </tbody> </table>	Recommended Timing	Maintenance Need	Deficiencies	Work	Timing	Performance	Material	REPLACE	1-5 YEAR	1-Load carrying capacity	6-Corrosion																	Description	Description	Description	Replace both abutment cross-frames		Both abutment cross-frames have perforations and/or very severe corrosion (75 to 100% section loss) in multiple members. Resistance to lateral forces reduced due to deterioration.	Asset Number	4921882	Element Group	BEAMS/MAIN LONGITUDINAL	Element Name	DIAPHRAGMS	Environment	MODERATE
Recommended Timing	Maintenance Need		Deficiencies																																								
Work	Timing		Performance	Material																																							
REPLACE	1-5 YEAR		1-Load carrying capacity	6-Corrosion																																							
Description	Description	Description																																									
Replace both abutment cross-frames		Both abutment cross-frames have perforations and/or very severe corrosion (75 to 100% section loss) in multiple members. Resistance to lateral forces reduced due to deterioration.																																									
Limited Insp.	NO	Protection System	Paint Coating	Units of Measure	Each	Qty. In Excellent Condition		Qty. In Good Condition		Qty. In Fair Condition		Qty. In Poor Condition	2.00	Total Quantity	2.00																												
Comments		Element Specifications		Location	At Abutments	Type	Built-Up Cross-Frames of Angle Sections	Material	STEEL	Length	3.90	Width	0.00	Height	0.00	Count	2																										
Severe to very severe corrosion with rust jacking and perforations on vertical gusset plates and top and bottom horizontal braces. Medium to very severe section loss typical in diagonal braces with localized small perforations.				Please do not change dimensions if the difference is < 2%																																							

Element: 018600, FLOOR BEAM, COATINGS, STRUCTURAL STEEL									
Work Order	11316576	Recommended		Maintenance		Deficiencies			
Asset Number	5033438	Work	REPLACE	Need		Performance		Material	
Element Group	COATINGS	Timing	1-5 YEAR	Timing		16-Other		15-Flaking Paint	
Element Name	STRUCTURAL STEEL							6-Corrosion	
Environment	MODERATE								
Limited Insp.	NO								
Protection System									
Units of Measure	Sq.m.	Description		Description		Description			
Qty. In Excellent Condition									
Qty. In Good Condition									
Qty. In Fair Condition									
Qty. In Poor Condition	122.40								
Total Quantity	122.40								
		Comments			Element Specifications				
		Complete coating failure with peeling, severe surface rust and undercutting.			Location	Intermediate Cross-Frames			
					Type	Alkyd Coating System			
					Material	PAINT_COATING			
					Length	0.00			
					Width	0.00			
					Height	0.00			
					Count	0			
<i>Please do not change dimensions if the difference is < 2%</i>									

Element: 018600, FLOOR BEAM, COATINGS, STRUCTURAL STEEL									
Work Order	11316575	Recommended		Maintenance		Deficiencies			
Asset Number	5033438	Work	REPLACE	Need		Performance		Material	
Element Group	COATINGS	Timing	1-5 YEAR	Timing		16-Other		15-Flaking Paint	
Element Name	STRUCTURAL STEEL							6-Corrosion	
Environment	MODERATE								
Limited Insp.	NO								
Protection System									
Units of Measure	Sq.m.	Description		Description		Description			
Qty. In Excellent Condition									
Qty. In Good Condition									
Qty. In Fair Condition									
Qty. In Poor Condition	48.96								
Total Quantity	48.96								
		Comments			Element Specifications				
		Complete coating failure with peeling, severe surface rust and undercutting.			Location	Abutment and Pier Cross-Frames			
					Type	Alkyd Coating System			
					Material	PAINT_COATING			
					Length	0.00			
					Width	0.00			
					Height	0.00			
					Count	0			
<i>Please do not change dimensions if the difference is < 2%</i>									

Element: 018600, FOUNDATION, FOUNDATIONS, FOUNDATION (BELOW GROUND LEVEL)									
Work Order	11316550	Recommended		Maintenance		Deficiencies			
Asset Number	4920537	Work		Need		Performance		Material	
Element Group	FOUNDATIONS	Timing		Timing					
Element Name	FOUNDATION (BELOW GRO								
Environment	BENIGN								
Limited Insp.	YES								
Protection System	None								
Units of Measure		Description		Description		Description			
Qty. In Excellent Condition									
Qty. In Good Condition									
Qty. In Fair Condition									
Qty. In Poor Condition									
Total Quantity	0.00								
		Comments			Element Specifications				
		No suspected performance deficiencies noted.			Location	Beneath Structure			
					Type				
					Material	STONE			
					Length	0.00			
					Width	0.00			
					Count	0			
<i>Please do not change dimensions if the difference is < 2%</i>									

Element: 018600, LATERAL BRACING, COATINGS, STRUCTURAL STEEL									
Work Order	11316577	Recommended		Maintenance		Deficiencies			
Asset Number	5033440	Work	REPLACE	Need		Performance		Material	
Element Group	COATINGS	Timing	1-5 YEAR	Timing				15-Flaking Paint	
Element Name	STRUCTURAL STEEL							6-Corrosion	
Environment	MODERATE								
Limited Insp.	NO								
Protection System									
Units of Measure	Sq.m.	Description		Description		Description			
Qty. In Excellent Condition									
Qty. In Good Condition									
Qty. In Fair Condition									
Qty. In Poor Condition	195.84								
Total Quantity	195.84								
		Comments			Element Specifications				
		Complete coating failure with peeling, severe surface rust and undercutting.			Location	Lateral Bracing			
					Type	Alkyd Coating System			
					Material	PAINT_COATING			
					Length	0.00			
					Width	0.00			
					Height	0.00			
		Count	0						
<i>Please do not change dimensions if the difference is < 2%</i>									

Element: 018600, PIER, ACCESSORIES (ATTACHMENTS AND SIGNS), PIER-NOSING									
Work Order	11316580	Recommended		Maintenance		Deficiencies			
Asset Number	5077504	Work	MAJOR REHAB	Need		Performance		Material	
Element Group	ACCESSORIES (ATTACHMEN	Timing	6-10 YEAR	Timing				7-Cracks	
Element Name	PIER-NOSING							8-Deformation	
Environment	MODERATE							6-Corrosion	
Limited Insp.	NO								
Protection System	None								
Units of Measure	Each	Description		Description		Description			
Qty. In Excellent Condition									
Qty. In Good Condition	5.00								
Qty. In Fair Condition									
Qty. In Poor Condition	2.00								
Total Quantity	7.00								
		Comments			Element Specifications				
		Steel nosing plate on pier 1 is detached and folded back on the southeast side. Wide vertical crack and separation extending from the top to halfway down the centre of the steel nosing plates on pier 2. No steel nosings on the south end of the footings of piers 1 and 2. Light corrosion is typical throughout.			Location	South ends of piers			
					Type	Angles and Plates			
					Material	STEEL			
					Length	0.00			
					Width	0.00			
					Height	0.00			
		Count	7						
<i>Please do not change dimensions if the difference is < 2%</i>									

Element: 018600, PIER, PIERS, SHAFTS/COLUMNS/PIER BENTS									
Work Order	11316564	Recommended		Maintenance		Deficiencies			
Asset Number	4923168	Work	MAJOR REHAB	Need	2-Bridge Cleaning	Performance		Material	
Element Group	PIERS	Timing	1-5 YEAR	Timing	2-YEAR			12-Disintegration	
Element Name	SHAFTS/COLUMNS/PIER BE							33-Spalling	
Environment	MODERATE							10-Delamination	
Limited Insp.	NO							31-Scour/Erosion	
Protection System	None							30-Scaling	
Units of Measure	Sq.m.	Description		Description		Description		7-Cracks	
Qty. In Excellent Condition									
Qty. In Good Condition	448.70								
Qty. In Fair Condition	220.60								
Qty. In Poor Condition	151.50								
Total Quantity	820.80								
		Comments			Element Specifications				
		Light to very severe spalling (9). Severe to very severe disintegration with exposed rebar (92). Light to very severe delaminations (35). Erosion and undermining of pier footings (4). Medium (9.5) to severe scaling (3.5). (8.24 m2). Narrow, medium (14) and wide (8) isolated cracks and map cracks, some with efflorescence (45). Medium honeycombing (0.6). Suspected disintegration beneath debris on top of piers. Pier footings are included in quantities. There is also non-offensive graffiti on Piers 1, 3 and 7.			Location	Within Rideau River			
					Type	Shafts			
					Material	CONC_CIP			
					Length	3.37			
					Width	8.40			
					Height	4.43			
		Count	7						
<i>Please do not change dimensions if the difference is < 2%</i>									

Element: 018600, RAILING, BARRIERS, HAND RAILINGS			
Work Order	11316565	Recommended	Maintenance
Asset Number	4923169	Work	Need
Element Group	BARRIERS	Timing	Timing
Element Name	HAND RAILINGS		
Environment	SEVERE		
Limited Insp.	NO		
Protection System	Paint Coating		
Units of Measure	m.	Performance	Deficiencies
Qty. In Excellent Condition			Material
Qty. In Good Condition	320.00		6-Corrosion
Qty. In Fair Condition		Description	Description
Qty. In Poor Condition			
Total Quantity	320.00		
Comments		Element Specifications	
Light corrosion throughout the railings and posts.		Location	On Top Flange of Girders
		Type	Double Rails and Pickets
		Material	STEEL
		Length	160.00
		Width	0.00
		Height	0.00
	Count	2	
<i>Please do not change dimensions if the difference is < 2%</i>			

Element: 018600, RAILING, COATINGS, RAILING SYSTEMS / HAND RAILINGS			
Work Order	11316578	Recommended	Maintenance
Asset Number	5077505	Work	Need
Element Group	COATINGS	Timing	Timing
Element Name	RAILING SYSTEMS / HAND R		
Environment	SEVERE		
Limited Insp.	NO		
Protection System	None		
Units of Measure	Sq.m.	Performance	Deficiencies
Qty. In Excellent Condition			Material
Qty. In Good Condition	98.74		16-Other
Qty. In Fair Condition	28.00	Description	Description
Qty. In Poor Condition	14.00		
Total Quantity	140.74		
Comments		Element Specifications	
Medium (28) to severe (14) surface rust and undercutting.		Location	Bridge Railings
		Type	
		Material	PAINT_COATING
		Length	160.00
		Width	0.07
		Height	0.07
	Count	4	
<i>Please do not change dimensions if the difference is < 2%</i>			

Element: 018600, SIDEWALK & BARRIER CURB, SIDEWALKS/CURBS, CURBS			
Work Order	11316552	Recommended	Maintenance
Asset Number	4920539	Work	Need
Element Group	SIDEWALKS/CURBS	Timing	Timing
Element Name	CURBS		
Environment	SEVERE		
Limited Insp.	NO		
Protection System	None		
Units of Measure	Sq.m.	Performance	Deficiencies
Qty. In Excellent Condition			Material
Qty. In Good Condition	209.40		3-Checks, Splits, shakes
Qty. In Fair Condition	4.00	Description	Description
Qty. In Poor Condition	2.00		
Total Quantity	215.40		
Comments		Element Specifications	
Collision damage on both curbs at both ends (2). Light to medium (4) checks and splits throughout. Light weathering and abrasion at asphalt interface.		Location	North and South Sides of Deck
		Type	Timber Curb
		Material	WOOD
		Length	160.00
		Width	0.19
		Height	0.24
	Count	2	
<i>Please do not change dimensions if the difference is < 2%</i>			

Element: 018600, TRUSS SWAY/LATERAL BRACING, BRACING, BRACINGS		
Work Order	11316571	
Asset Number	4925720	
Element Group	BRACINGS	
Element Name	BRACINGS	
Environment	MODERATE	
Limited Insp.	NO	
Protection System	Paint Coating	
Units of Measure	Each	
Qty. In Excellent Condition		
Qty. In Good Condition		
Qty. In Fair Condition		
Qty. In Poor Condition	96.00	
Total Quantity	96.00	
Work	REPLACE	
Recommended Timing	1-5 YEAR	
Maintenance Need		
Maintenance Timing		
Performance		1-Load carrying capacity
Material		6-Corrosion
		5-Connection Deficiencies
Description	Replace all lateral bracing	All lateral braces have perforations and/or very severe corrosion (75 to 100% section loss) in multiple members. Resistance to lateral forces reduced due to deterioration.
Comments	Severe to very severe corrosion typical on horizontal gusset plates. Localized perforations on horizontal gusset plates and some diagonal members. Detachment of diagonal member from gusset plate in multiple locations. Light to medium corrosion typical on diagonal members with localized very severe corrosion and perforations.	
Element Specifications		
Location	Between Girders Below Deck	
Type	Steel Angle	
Material	STEEL	
Length	5.10	
Width	0.00	
Height	0.00	
Count	96	
<i>Please do not change dimensions if the difference is < 2%</i>		

Element: 018600, WALL OR WALL PANEL, RETAINING WALLS, WALLS		
Work Order	11316556	
Asset Number	4921883	
Element Group	RETAINING WALLS	
Element Name	WALLS	
Environment	SEVERE	
Limited Insp.	NO	
Protection System	Galvanized Coating	
Units of Measure	Sq.m.	
Qty. In Excellent Condition		
Qty. In Good Condition		12.00
Qty. In Fair Condition		
Qty. In Poor Condition		
Total Quantity		12.00
Work		
Recommended Timing		
Maintenance Need		
Maintenance Timing		
Performance		
Material		
Description		
Comments	Slight bulging of the end basket at the northeast.	
Element Specifications		
Location	Behind Wingwalls at NW, NE and SE	
Type	Gabion Baskets	
Material	GABION	
Length	2.00	
Width	1.00	
Height	1.00	
Count	3.00	
<i>Please do not change dimensions if the difference is < 2%</i>		

Element: 018600, WATERCOURSE, EMBANKMENTS AND STREAMS, STREAMS AND WATERWAYS		
Work Order	11316551	
Asset Number	4920538	
Element Group	EMBANKMENTS AND STREA	
Element Name	STREAMS AND WATERWAY	
Environment	BENIGN	
Limited Insp.	NO	
Protection System	None	
Units of Measure	All	
Qty. In Excellent Condition		
Qty. In Good Condition		1.00
Qty. In Fair Condition		
Qty. In Poor Condition		
Total Quantity		1.00
Work		
Recommended Timing		
Maintenance Need		
Maintenance Timing		
Performance		
Material		
Description		
Comments	Light aggradation of the streambed at the north (downstream) end of the piers and a few locations of scouring of the streambed at the south (upstream) end. Flow clearance was 4.2 m at the time of inspection. River flow is from south to north.	
Element Specifications		
Location	Rideau River Below Structure	
Type		
Material	UNKNOWN	
Length	0.00	
Width	0.00	
Height	0.00	
Count	1	
<i>Please do not change dimensions if the difference is < 2%</i>		

Element: 018600, WINGWALL, ABUTMENTS, WINGWALLS									
Work Order	11316573	Recommended Work		Maintenance Need		Deficiencies			
Asset Number	4926921	Timing	1-5 YEAR	Timing	2-YEAR	Performance		Material	
Element Group	ABUTMENTS	MAJOR REHAB		2-Bridge Cleaning				12-Disintegration	
Element Name	WINGWALLS							1-Aggregate Alkali Reaction	
Environment	SEVERE							7-Cracks	
Limited Insp.	NO							6-Corrosion	
Protection System	None							30-Scaling	
								10-Delamination	
Units of Measure	Sq.m.	Description		Description		Description			
Qty. In Excellent Condition		Extensive concrete repairs to wingwalls		Remove graffiti at NW, NE and SE					
Qty. In Good Condition	3.50								
Qty. In Fair Condition	34.20								
Qty. In Poor Condition	19.20								
Total Quantity	56.90								
Comments					Element Specifications				
Severe disintegration up to 150 mm deep with exposed corroded rebar on both wingwalls (18). Severe to very severe delaminations on southwest, southeast and northeast wingwalls (1). Medium (0.5) to wide (0.2) horizontal crack with efflorescence on southwest wingwall. Medium AAR on each wingwall (14). Medium scaling on face of northwest wingwall (0.5). Non-offensive graffiti at southeast, northeast, and northwest.					Location	Quadrants			
					Type				
					Material	CONC_CIP			
					Length	5.60			
					Width	0.70			
					Height	1.84			
Count	4.00								
<i>Please do not change dimensions if the difference is < 2%</i>									

APPENDIX B

Selected Inspection Photographs



Photo 1 – North elevation of the Old Railway Rideau River Pedestrian Bridge. Note low-lying island downstream of Pier 5 and University of Ottawa (Lees Campus) located on west side of the river (background).



Photo 2 – South elevation. Note Rideau River Western Pathway (foreground), which passes below Span 8.



Photo 3 – West approach, looking east across top of deck. Impact damage to ends of timber curbs and top flange cover plate of south girder. Note transverse downslope of deck towards north and deck drains along interior of timber curb.



Photo 4 – East approach, looking west across top of deck. Impact damage to ends of timber curbs. Note horizontal curved alignment of the structure towards the north.



Photo 5 –South elevation. Rideau River Western Pathway passing in front of west abutment below Span 8; vertical clearance of 2.5 m. Note Highway 417 (Queensway) Hurdman Bridge pier in background.



Photo 6 – Typical condition of asphalt wearing surface on the deck top, looking east. Note the light to severe isolated unsealed transverse cracks and light raveling throughout, with medium raveling on exterior of timber curbs.



Photo 7 – Light to severe isolated unsealed transverse cracks and asphalt break-up with a pothole at the expansion joint at Pier 6.



Photo 8 – Light to severe unsealed progressive edge cracks and isolated cracks at the expansion joint at Pier 3.



Photo 9 -Light to medium ravelling typical throughout the east approach wearing surface.



Photo 10 - Underside of Span 7, looking east. Areas of wet staining throughout the soffit of the laminated timber deck. Note water was observed penetrating through the laminated timber deck during the inspection, when raining.



Photo 11 – Light to medium checks in the soffit and ledger and a severe split which has splintered a board in the soffit at the curb bolt. There is a piece of splintered curb timber lodged in the rectangular deck drain at the east abutment.



Photo 12 – Very severe impact damage to the west end of the south timber curb. Note the impact damage with cracking and light corrosion in the cover plate of the steel girder.



Photo 13 – Impact damage to the east end of the south timber curb.



Photo 14 – Light to severe longitudinal splits in the curb from the bolts. Typical localized light weathering is also visible in the top and interior face of curb.



Photo 15 – Broken end of compression seal at Pier 2.



Photo 16 – Failed section expansion joint compression seal sagging below deck at Pier 4.



Photo 17 – Significant section of debonded expansion joint compression seal sagging below deck at Pier 4. Light to medium corrosion on expansion joint angle bolts.

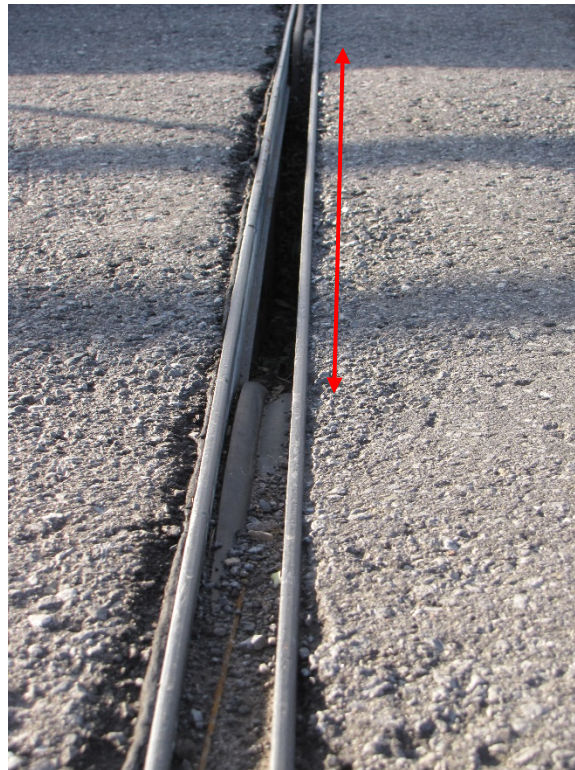

Photo 18 – Failed expansion joint compression seal is sagging below at the west abutment. Also note the asphalt break-up at the expansion joint angles.



Photo 19 – Medium to severe raveling between the exterior face of the timber curb and girder web. Note typical good condition of deck drain gratings.



Photo 20 – Typical good condition of the deck drain downsouts with light corrosion on ends.



Photo 21 – Rectangular deck drainage openings located every 2 m on each side of deck. Note the medium to severe ravelling and wet staining of the asphalt along the girder web.



Photo 22 – Rectangular deck drainage opening with no downspout. Note the corrosion staining on the timber ledger and severe corrosion on shelf angle below caused by deck runoff outlet directly onto structure components below.



Photo 23 – Localized light corrosion throughout both steel rails and steel pickets on the steel pipe railings due to deterioration of the coating system.



Photo 24 – Severe to very severe corrosion at the base of the approach railing posts embedded into the top of the concrete wingwalls.



Photo 25 – Very severe corrosion with approximately 75% section loss at the base of a railing post on the southeast wingwall.



Photo 26 – Localized light corrosion on the exterior girder top of bottom flange and below the top flange.



Photo 27 – Localized light corrosion on the top flange of the girder. Typical light to medium corrosion on the girder web and knee braces (i.e. vertical gusset plates) along the top of the asphalt wearing surface.



Photo 28 – Impact damage to the top of flange and light corrosion at the west end of the south girder.



Photo 29 – Light to medium corrosion with rust jacking between cover plates on the top flange of the north girder.



Photo 30 – Typical condition on the interior of the girder below deck. Medium to severe corrosion on the shelf angle below the ledger and bottom flange. Very severe corrosion and perforations in the vertical gusset plate. Corrosion with up to 100% section loss on rivet heads. Typical coating failure with widespread peeling paint.



Photo 31 - 100% section loss in the top brace and vertical gusset plate of the cross-frame 2 bays east of Pier 1.



Photo 32 - Cross-frame 3 bays east of Pier 2 has 100% section loss in the bottom brace.



Photo 33 – Cross-frame at Pier 4 complete section loss on the top brace and perforation in the vertical gusset plate.



Photo 34 – Cross-frame in the bay just east of Pier 6 has 100% section loss in the top brace.



Photo 35 – Cross-frame 2 bays west of Pier 5. Perforation full width of the vertical gusset plate and severe deformation of the top brace member.



Photo 36 – Severe to very severe corrosion and localized or complete perforations in the diagonal brace, top brace, and vertical gusset plate at the north end of the west abutment cross-frame.



Photo 37 – Severe to very severe corrosion on the rivet heads a diagonal brace and very severe corrosion with perforation in the bottom brace.



Photo 38 – Very severe corrosion with complete perforation across the vertical gusset plate and detachment of the lateral brace from the horizontal gusset plate at the south end of the west abutment cross-frame.



Photo 39 – Complete detachment of the lateral brace from the horizontal gusset plate at the cross-frame in the bay just east of Pier 6.



Photo 40 – Very severe corrosion on the horizontal gusset plate and lateral brace at the cross-frame in the bay just west of Pier 6, resulting in detachment of the lateral brace.



Photo 41 – Typical condition of the lateral bracing. Note the widespread coating failure and light to medium corrosion throughout.



Photo 42 – South elevation of the exterior girders webs; coating in generally good condition.



Photo 43 - Light to severe corrosion on the north expansion bearing of the east abutment. Note the significant accumulation of corroded steel and disintegrated concrete on the bearing and bearing seat.



Photo 44 - Medium to severe corrosion on the north fixed bearing of the west abutment.



Photo 45 – Pier 2 south bearings. Widespread coating failure, medium to severe corrosion and significant accumulation of debris on top of the bearings and bearing seat.



Photo 46 – Southeast bearing on Pier 7 is cracked and was previously temporarily repaired with a clamping device. Note the deformation on the bottom flange of the south girder.



Photo 47 – Northwest bearing anchor bolt on Pier 4 has sheared off. Note the extensive concrete disintegration with exposed corroded reinforcing steel at the top of the pier shaft and bearing seat.



Photo 48 – East abutment. very severe disintegration throughout with spalls, delaminations and exposed corroded rebar on the abutment wall and footing.



Photo 49 – Very severe disintegration at the top of the east abutment wall and bearing seat at the north end.



Photo 50 – Very severe disintegration at the top of the east abutment wall and bearing seat at the south end.



Photo 51 – Very severe disintegration on the ballast wall and adjacent to the south expansion bearing at the east abutment. Note vegetation growth in bearing seat.



Photo 52 – Localized area of very severe disintegration in the west abutment wall and very severe disintegration and delamination with exposed corroded rebar on the north end of the ballast wall.



Photo 53 – Severe to very severe disintegration and delamination with exposed corroded rebar on the north end of the ballast wall.



Photo 54 – Severe to very severe disintegration and delaminations with exposed corroded rebar at the south end of the ballast wall and southwest wingwall.



Photo 55 – Wet and efflorescence stained hairline to narrow map cracking throughout, wet staining and medium honeycombing in the west abutment wall.



Photo 56 – Severe to very disintegration with exposed corroded rebar at the north end of the east ballast wall.



Photo 57 – Hairline to narrow wet and efflorescence stained map cracking in the east ballast wall.



Photo 58 – Extensive areas of medium to very severe disintegration with exposed corroded rebar, delaminations, and hairline to narrow wet and efflorescence stained map cracking on the southeast wingwall.



Photo 59 – Extensive areas of medium to very severe disintegration with exposed corroded rebar and hairline to narrow wet and efflorescence stained map cracking on the northeast wingwall.



Photo 60 – Light to very severe disintegration and spalls with exposed corroded rebar and hairline to narrow wet and efflorescence stained map cracking on the southwest wingwall. Very severe delamination adjacent to the ballast wall.



Photo 61 – Medium to very severe disintegration and delamination with exposed corroded rebar on the northwest wingwall. Localized area of efflorescence stained hairline to narrow map cracking.



Photo 62 – Pier 1 steel nosing plate on southeast face is detached and folded back. Note lack of a steel nosing angle or plate on the upstream nosing of the footing with a very severe spall.



Photo 63 – Pier 2 steel nosing plate is cracked and separated, extending from the top to midway down the center of the plate. Note lack of a steel nosing angle or plate on the upstream nosing of the footing with a very severe spall.



Photo 64 – Pier 3, west elevation. Severe to very severe disintegration with exposed corroded rebar at the bearing seat, isolated cracks and map cracking with wet or efflorescence staining, and wide horizontal construction joints.



Photo 65 – Pier 4, west elevation. Severe to very severe disintegration with exposed corroded rebar throughout the face of the pier, wet and efflorescence staining, and localized rust staining.



Photo 66 – Pier 4, south end. Severe to very severe disintegration and delamination on the bearing seat up to the bearings.



Photo 67 – Pier 5, west elevation. Extensive very severe disintegration with exposed corroded rebar at the bearing seat and wide horizontal construction joint.



Photo 68 – Pier 6, west elevation. Extensive very severe disintegration with exposed corroded rebar, delaminations and efflorescence staining at the bearing seat, and map cracking with efflorescence.



Photo 69 – Pier 6, north end. Very severe disintegration with exposed corroded reinforcing steel on the bearing seat up to the bearings.



Photo 70 – Pier 6. South end of the footing is undermined by approximately 450 mm on each face.



Photo 71 – Pier 7, north elevation. Severe to very severe disintegration below the horizontal construction joint and at the bearing seat.



Photo 72 – Embankment in front of the east abutment in fair condition due to erosion of embankment material. Southeast and northeast embankments well vegetated, but steep.



Photo 73 – Southwest embankment is well vegetated with light erosion due to a foot path leading down from the top of the embankment to the multi-use pathway below.



Photo 74 – Northwest embankment and rip-rap slope protection is in good condition.



Photo 75 – Typical shallow water depth across the waterway between piers. Riverbed consisting of bedrock or with a shallow layer of silt and sand on bedrock.



Photo 76 – Gabion basket retaining wall located at the end of the northwest wingwall is in good condition.



Photo 77 – Gabion basket retaining wall located at the end of the northeast wingwall with slight bulging.

APPENDIX C

Underwater Inspection Memo (ODS Marine)



6866 McKeown Drive, Greely, Ontario, K4P 1A2
Telephone: 613 821-3988 / Fax: 613 821-2766
E-mail <mailto:ods@odsmarine.com>
Web page www.odsmarine.com

COMMERCIAL DIVING • BOAT, BARGE, TUG RENTALS • MARINE CONSTRUCTION & ENGINEERING SERVICES

Date: Sept 28/2018

Parsons Engineering

Attn: Patrick Mergel

Re: Rideau River Pedestrian Bridge In-Water Inspection

Date of Inspection: June 11, 2018

Scope of Work:

ODS Marine to provide support to conduct in-water pier inspections by CCTV underwater camera, light and live voiceover. The UW camera was attached to pole for handheld method with man in drysuit and the support station was set up from the deck of the bridge. This method was utilized due to the shallow water depth around the piers.

Summary of Overall Condition of Bridge Footing's 1-7

Piers 1-7 appear to have some minor issues on the concrete footings (see below observations)
Water level at the time of inspection allowed the surface crew to inspect 2/3's of the footing in the dry, as the top of footing was approx. 300-900mm above the water line.

- Light to heavy marine growth buildup found on all piers
- Bottom substrate surrounding footings was a mix of small stones, sand, and some larger stones. The footings did not appear to have any placed riprap or any natural scour protection along footings.

Note: Footing Inspection(s) start at the Downstream (North) and follow down the west face of the footing to the Upstream.

Observations:

Pier #1

North West Face of Footing:

- Water depth is approx. 500mm
- Doesn't appear to show any signs of undermining.
- Light map cracking along footing, noticeable above waterline. (2:29)
- Heavy marine growth at base of footing, zebra mussels, small clams



6866 McKeown Drive, Greely, Ontario, K4P 1A2
Telephone: 613 821-3988 / Fax: 613 821-2766
E-mail <mailto:ods@odsmarine.com>
Web page www.odsmarine.com

COMMERCIAL DIVING • BOAT, BARGE, TUG RENTALS • MARINE CONSTRUCTION & ENGINEERING SERVICES

West Face of Footing:

- Water depth is approx. 500mm to 1.3m
- West face has a second footing that begins approx. 1m from the north transition. *(3:14)*
- Second footing is approx. 300mm high off bottom, and 150mm wide across the top.
- Transition between second and main footing doesn't show any signs of separation.
- Horizontal crack above waterline runs entire length of footing
- Doesn't appear to show any signs of undermining
- Light to medium spalling begins along both footings approx. 1m north of transition to south (upstream nose)
- Major spalling above water line at transition *(7:09)*

South West Face:

- Water depth is approx. 1.3m
- Horizontal crack runs the entire length above water.
- Minor map cracking visible above water
- Bottom material is comprised of larger stone debris
- Undermining 1m back from nosing, appears to be approx. 200mm wide by 100mm high, estimated depth of undermining to be around 100-200mm. *(9:30)*
- Major spalling at nosing above waterline *(10:13)*
- Undermining at nose approx. 300mm high and 400-600mm wide.

South East Face:

- Water depth is approx. 1.3m sloping north to 300mm
- Appears to have a few small areas of undermining.
- Minor marine growth.
- Steel jacketing on pier is starting to peel off *(10:27)*

East Face of Footing:

- Water Depth is 300mm sloping towards 400-600mm
- Horizontal crack continues from south face
- Footing appears to be in sound condition, little sign of undermining or deterioration.

North East Face:

- Vertical crack 400mm back from the east transition *(15:03)*
- Area of undermining at the transition to the east face *(15:07)*
- Horizontal crack above water line continues for entirety.



6866 McKeown Drive, Greely, Ontario, K4P 1A2
Telephone: 613 821-3988 / Fax: 613 821-2766
E-mail <mailto:ods@odsmarine.com>
Web page www.odsmarine.com

COMMERCIAL DIVING • BOAT, BARGE, TUG RENTALS • MARINE CONSTRUCTION & ENGINEERING SERVICES

Pier #2

North West Face of Footing:

- Water depth is approx.
- Horizontal crack above waterline
- Minor delamination along footing above water line (*1:31*) runs entire length of face.
- Undermining 1.5m long from north west corner towards north, approx. 200mm high and 150mm deep (*2:48*)

West Face of Footing:

- Water depth is 300-500mm
- Undermining continues from north 300mm
- Horizontal crack above waterline continues
- Light map cracking below waterline
- Minor spalling closer towards the upstream nose (*6:24*)

South West Face of Footing:

- Water depth is approx. 300mm
- Horizontal cracking continues along face (*7:30*) (*8:11*)
- Minor spalling below water line
- Major spalling at nose (*8:52*)
- No visible signs of undermining, Bottom material piled against footing on west face.

South East Face of Footing:

- Water depth is approx. 300mm
- Horizontal crack continues
- Major spalling at surface, minor below water line
- Top of footing is approx. 300mm above waterline
- Minor delamination in a few areas above waterline.

East Face:

- Water depth is approx. 300mm
- Horizontal crack continues along entire face
- Minor undermining at transition to north east face. (*16:00*)

North East Face:

- Minor map cracking above water line
- Horizontal crack above waterline (*18:26*)



6866 McKeown Drive, Greely, Ontario, K4P 1A2
Telephone: 613 821-3988 / Fax: 613 821-2766
E-mail <mailto:ods@odsmarine.com>
Web page www.odsmarine.com

COMMERCIAL DIVING • BOAT, BARGE, TUG RENTALS • MARINE CONSTRUCTION & ENGINEERING SERVICES

Pier #3

North West Face of Footing:

- Entire footing is above water line (*0:18*)

West Face:

- Water depth is approx. 50mm at the north end sloping towards 200mm at south end
- Doesn't appear to be any signs of undermining
- Minor map cracking below waterline
- Light spalling above waterline

South West Face of Footing:

- Extensive damage to steel nosing plate, major spalling above waterline (*3:14*)
- Undermining along entire face approx. 50mm high (*5:11*)
- Steel nosing appears to be in good conditions below waterline

South East Face:

- Water depth is approx. 300mm
- Steel nosing plate stops 150mm past nose, transition between steel and concrete appears to be in good condition (*6:50*)
- Light spalling at waterline

East Face:

- Water depth approx. 300mm sloping to above water
- Minor undermining along face
- Approx. $\frac{3}{4}$ of the footing is above waterline (*9:05*)

North East:

- Above waterline

Pier #4

North West Face of Footing:

- Water depth approx. 150mm-200mm
- Section appears to be in good condition with no visible signs of undermining



6866 McKeown Drive, Greely, Ontario, K4P 1A2
Telephone: 613 821-3988 / Fax: 613 821-2766
E-mail <mailto:ods@odsmarine.com>
Web page www.odsmarine.com

COMMERCIAL DIVING • BOAT, BARGE, TUG RENTALS • MARINE CONSTRUCTION & ENGINEERING SERVICES

West Face:

- Minor map cracking above waterline
- Interface between bedrock and footing appears to have small amounts of undermining (**4:05**)
- Minor spalling above waterline

South West Face:

- Major spalling at the waterline, behind the steel nosing and beside the transition to the west face (**5:43**)
- Steel plating extends approx. 200mm below waterline and doesn't show to have good bonding to the pier.

South East Face:

- Steel nosing appears to be in good condition with only minor spalling at the nose (**8:32**)
- Steel interface with concrete appears to have good bonding (**9:13**)
- Horizontal crack above waterline

East Face:

- Water depth is approx. 200-300mm
- Undermining at transition to south east face extends approx. 3m (**10:49**)
- Horizontal crack 100mm above waterline
- Minor delamination above waterline

North East Face:

- Water depth is approx. 150-250mm
- Footing on this face appears to be in good condition with little signs of undermining or abnormalities to the concrete surface.

Pier # 5

North West Face of Footing:

- Water depth is approx. 150mm
- Section of footing appears to be in good condition with little sign of undermining or concrete damage.



6866 McKeown Drive, Greely, Ontario, K4P 1A2
Telephone: 613 821-3988 / Fax: 613 821-2766
E-mail <mailto:ods@odsmarine.com>
Web page www.odsmarine.com

COMMERCIAL DIVING • BOAT, BARGE, TUG RENTALS • MARINE CONSTRUCTION & ENGINEERING SERVICES

West Face:

- Water depth at north corner is 150mm – sloping towards South
- Small area of undermining approx. 3m from north transition (*4:18*)
- Undermining along footing at south end (*6:19*)

South West Face of Footing:

- Water Depth is approx. 750mm-1m
- Steel nosing plate along footing has heavy spalling underneath at the west face transition (*6:40*)
- Undermining continues towards the south nose (*7:28*)
- Steel nosing extends approx. 200mm below water line (*9:55*)

South East Face:

- Undermining approx. 1m back from nosing (*11:32*)
- Minor marine growth covering footing

East Face:

- Water depth is aprons 250mm
- Map cracking above water line
- Vertical crack (*15:32*) which joins a horizontal crack (*15:40*) along footing approx. 300mm above waterline and 3m from the south transition, extending approx. 1m
- Minor cracking towards north end above waterline

North East Face:

- Water depth is approx. 150mm at east face sloping to 50mm at north.
- Concrete appears to be in good condition

Pier # 6

North West Face of Footing:

- Approx. water depth is 150mm
- Doesn't appear to show any signs of undermining
- Concrete doesn't appear to show any major damage

West Face:

- Water depth is approx. 300mm
- Horizontal crack above waterline



6866 McKeown Drive, Greely, Ontario, K4P 1A2
Telephone: 613 821-3988 / Fax: 613 821-2766
E-mail <mailto:ods@odsmarine.com>
Web page www.odsmarine.com

COMMERCIAL DIVING • BOAT, BARGE, TUG RENTALS • MARINE CONSTRUCTION & ENGINEERING SERVICES

- Transition between footing and bedrock appears to be in good condition

South West face:

- Minor cracking above waterline (*7:54*)
- Nosing plate has a steel angle for scour protection 150mm x 150mm

South East Face:

- Concrete to steel interface at nosing appears to be in good condition with little sign of separation
- Horizontal crack above waterline (*12:53*)
- Undermining approx. 1m from nosing extends towards east face. 100mm high and 100-175mm deep (*14:51*)
- Footing is sitting on larger stone, material at transition (*16:01*)

East Face:

- Approx. water depth is 750mm- 1m sloping towards the north down to 300mm
- Continuation of undermining extends approx. 2m
- Minor segregation of aggregate 1.5m from south corner top of footing (*19:44*) and along face (*20:22*)
- Horizontal crack extends approx. half the length of footing (*21:08*)

North East Face:

- Entire section of footing is above waterline

Pier #7

North West Face of Footing:

- Water depth is approx. 250mm
- Horizontal crack begins 600mm back from west face at waterline (*2:41*)
- No signs of undermining

West Face:

- Horizontal crack continues just below waterline and extends approx. 2.5m, doesn't appear to show any separation after 2.5m, light spalling continues for the remainder of the footing (*4:54*)
- Map cracking above waterline
- Approx. water depth is 300mm



6866 McKeown Drive, Greely, Ontario, K4P 1A2
Telephone: 613 821-3988 / Fax: 613 821-2766
E-mail <mailto:ods@odsmarine.com>
Web page www.odsmarine.com

COMMERCIAL DIVING • BOAT, BARGE, TUG RENTALS • MARINE CONSTRUCTION & ENGINEERING SERVICES

South West Face:

- Water depth is 50mm
- Horizontal crack continues for entirety of face
- Steel nosing approx. 150mm x 150mm
- No signs of undermining
- Heavy spalling on top of footing (*10:01*)

South East Face:

- Map cracking above waterline
- Light spalling above waterline (*10:49*)
- Horizontal crack above waterline approx. 1m from nose (*12:12*)

East Face:

- Water depth 500-750mm
- Horizontal crack above waterline continues down east face, ties into vertical crack approx. 3m from north (*15:31*)
- Water depth 3m from north is 150mm

North East:

- Water depth is 200mm
- Doesn't appear to show any signs of undermining
- Horizontal crack along waterline continues down length 2m (*18:40*)

Please refer to video time stamps for images

Mike Fleming
ODS Marine
mike@odsmarine.com
613-715-2721

APPENDIX D

Deterioration Drawings

Drawing Frame: 790mm x 540mm City of Ottawa, 2008 (Rev. 0)
 Plot Date: Monday, November 19, 2018 11:22:00 AM
 Consultant's Information: H:\ISO\762601\000 - Old Railway Rideau River Ped Bridge\DKGS01 Working Drawings\ISO18600-Condition Assessment And Renewal Options\Drawings\General Arrangement.dwg
 Plot Date: Monday, November 19, 2018 9:11:19 AM

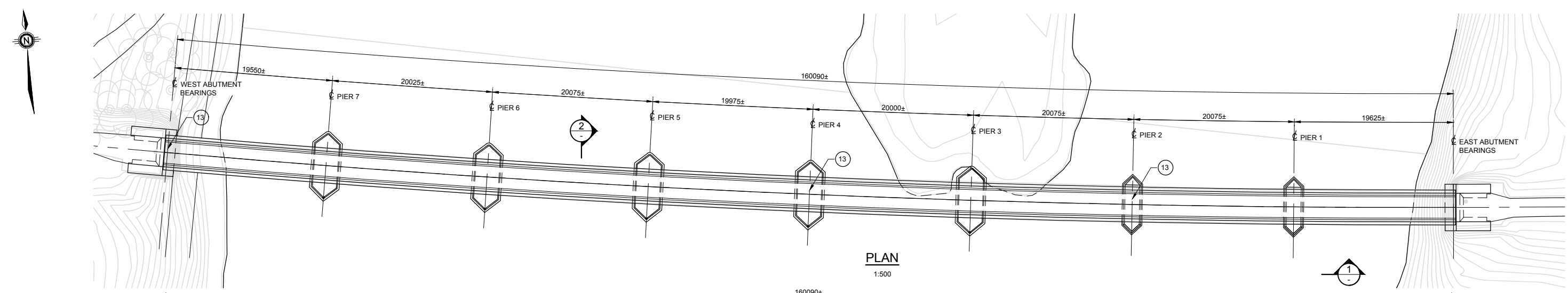

PLAN
1:500

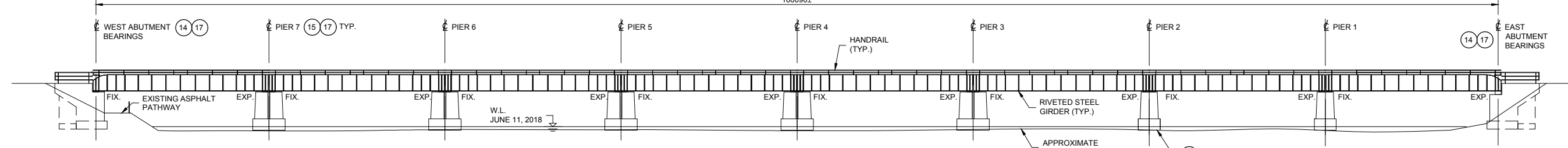

ELEVATION 1
1:500

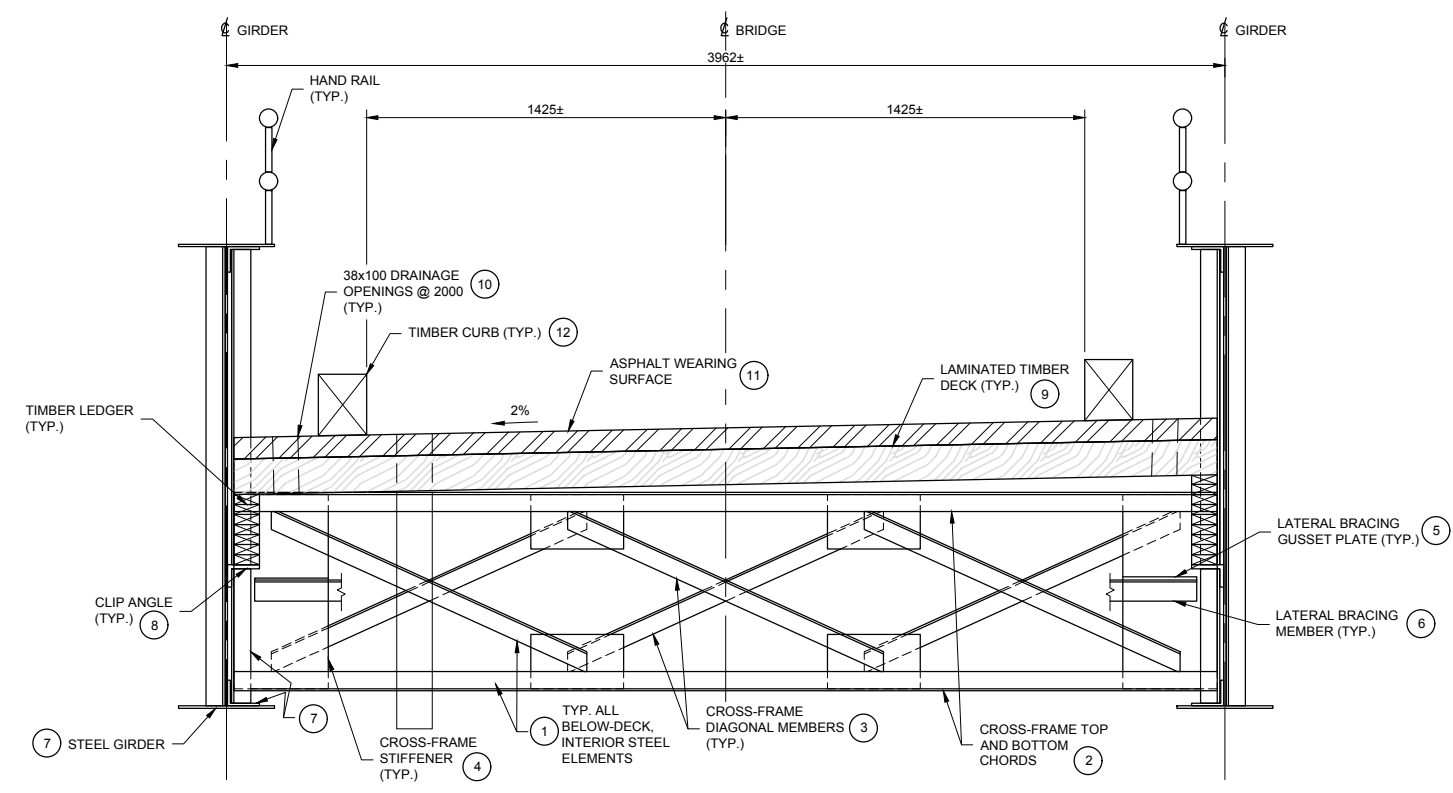

SECTION 2
1:30

TYPICAL DETERIORATION/DEFICIENCIES

1. TYPICAL COATING FAILURE THROUGHOUT ALL INTERIOR, BELOW DECK STEEL ELEMENTS
2. VERY SEVERE CORROSION WITH PERFORATIONS UP TO THE FULL SECTION THICKNESS IN THE TOP AND BOTTOM CHORDS
3. VERY SEVERE CORROSION WITH PERFORATIONS IN DIAGONAL MEMBERS
4. VERY SEVERE CORROSION WITH PERFORATIONS UP TO THE FULL WIDTH OF THE CROSS-FRAME STIFFENERS
5. EXTENSIVE VERY SEVERE CORROSION AND PERFORATIONS IN THE HORIZONTAL GUSSET PLATE CAUSING COMPLETE DETACHMENT OF THE LATERAL BRACING MEMBERS AT 3 LOCATIONS
6. MEDIUM TO VERY SEVERE CORROSION WITH PERFORATIONS IN THE LATERAL BRACING MEMBERS
7. MEDIUM TO SEVERE CORROSION TYPICAL THROUGHOUT BOTTOM OF BOTTOM FLANGES AND INTERIOR, BELOW DECK AREAS OF STEEL GIRDERS' WEBS AND FLANGES. VERY SEVERE CORROSION AND PERFORATIONS ON STIFFENERS, BOTTOM ANGLES AND RIVETS
8. SEVERE TO VERY SEVERE CORROSION WITH SEVERE PERFORATIONS IN CLIP ANGLES
9. WATER STAINING IN LAMINATED TIMBER DECK
10. MISSING DOWNSPOUT ON RECTANGULAR DECK DRAINS
11. ASPHALT BREAK-UP, RAVELLING, WIDE TRANSVERSE CRACKS AND WIDE PROGRESSIVE EDGE CRACKING IN ASPHALT. SUSPECTED FAILURE OF WATERPROOFING
12. IMPACT DAMAGE TO ENDS OF TIMBER CURBS
13. STRIP SEAL EXPANSION JOINT HAS FAILED AT 3 LOCATIONS
14. EXTENSIVE VERY SEVERE DISINTEGRATION WITH EXPOSED CORRODED REBAR ON ABUTMENT WALLS, WINGWALLS AND BEARING SEATS. AAR ON BALLAST WALLS
15. TYPICAL EXTENSIVE VERY SEVERE DISINTEGRATION, SPALLING AND DELAMINATION WITH EXPOSED CORRODED REBAR ON BEARING SEATS, AND PIER FACES AT EACH PIER
16. LIGHT TO SEVERE AREAS OF UNDERMINING BETWEEN CONCRETE PIER FOOTINGS AND BEDROCK
17. MEDIUM TO VERY SEVERE CORROSION ON ALL BEARINGS



NOTE:



OLD RAILWAY RIDEAU RIVER PEDESTRIAN BRIDGE STRUCTURE No. 018600 DETAILED CONDITION ASSESSMENT

GENERAL ARRANGEMENT EXISTING STRUCTURE TYPICAL DETERIORATION/DEFICIENCIES

476506	NOVEMBER 2018	Sheet No. 01
--------	---------------	--------------

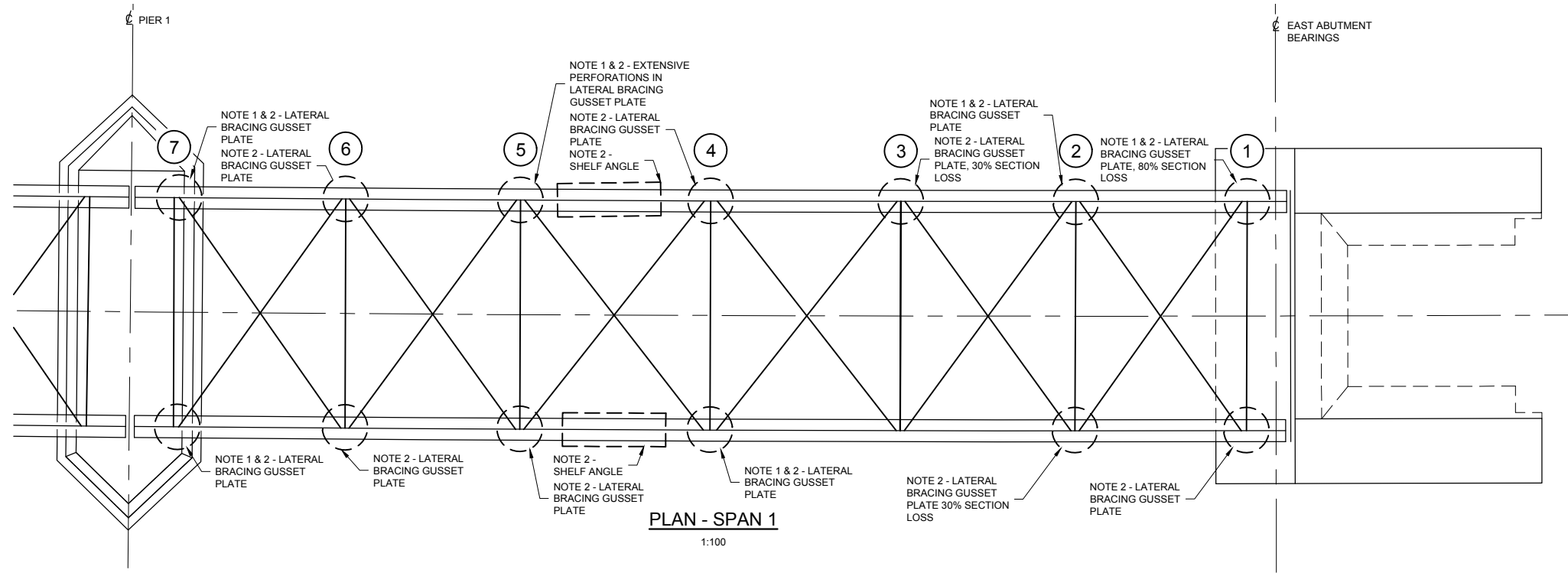

LEGEND:
 CROSS-FRAME 2-3 - CROSS-FRAME (SPAN)-(FRAME NO.)
 NOTE 1 - STRUCTURAL STEEL PERFORATIONS
 NOTE 2 - SEVERE TO VERY SEVERE CORROSION

-NORTH-

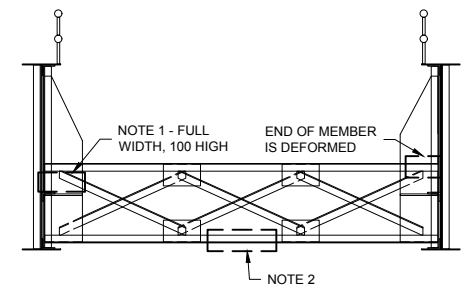

CROSS-FRAME 1-1
1:75

-SOUTH-

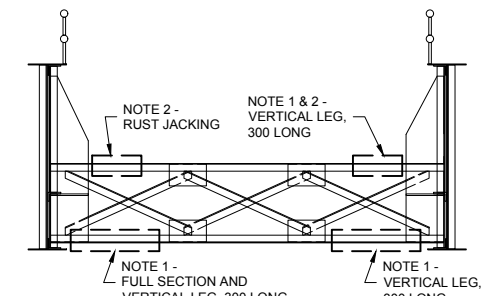

CROSS-FRAME 1-2
1:75

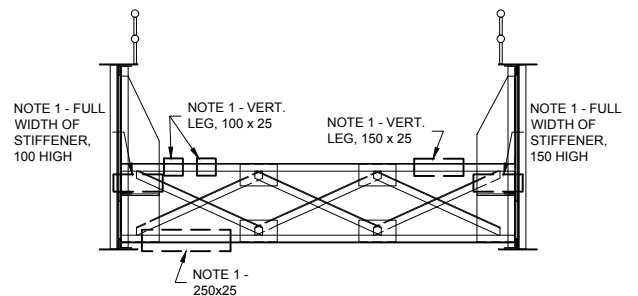

CROSS-FRAME 1-3
1:75

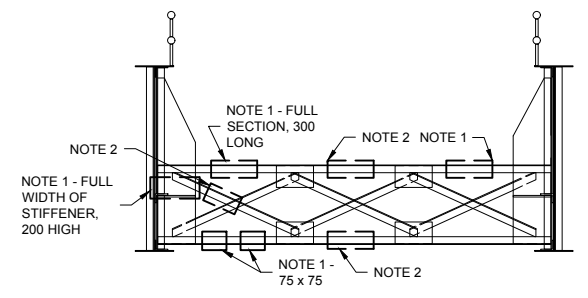

CROSS-FRAME 1-4
1:75

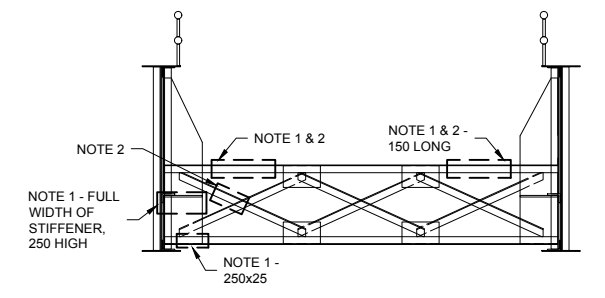

CROSS-FRAME 1-5
1:75

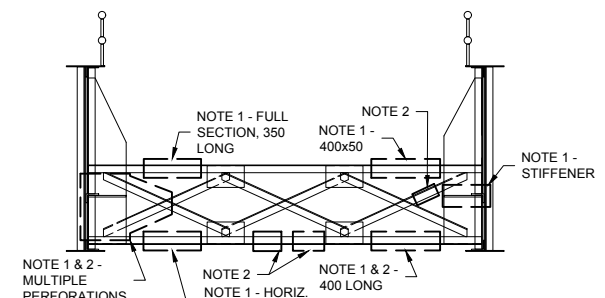

CROSS-FRAME 1-6
1:75

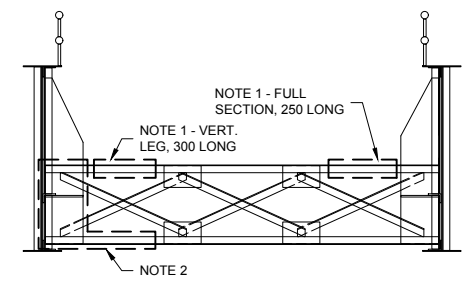

CROSS-FRAME 1-7
1:75

NOTE:
 CROSS-FRAME ELEMENTS BELOW THE TIMBER DECK ARE IN POOR CONDITION ON ACCOUNT OF SEVERE TO VERY SEVERE CORROSION THROUGHOUT.



Contract #: ISD17-7087

**OLD RAILWAY RIDEAU
 RIVER PEDESTRIAN BRIDGE
 STRUCTURE No. 018600
 DETAILED CONDITION ASSESSMENT**

SPAN 1 DETERIORATION

Drawing Frame: 790mm x 540mm City of Ottawa, 2008 (Rev.0)
 Plot Date: Monday, November 19, 2018 11:22:33 AM
 Thursday, October 25, 2018 1:01:15 PM
 Consultant's Information: H:\BO\762600\1000 - Old Railway Rideau River Ped Bridge\DKGS01 Working Drawings\SN018600-Condition Assessment\02-09-Structural Steel\Detail Saved



LEGEND:
 CROSS-FRAME 2-3 - CROSS-FRAME (SPAN)-(FRAME NO.)
 NOTE 1 - STRUCTURAL STEEL PERFORATIONS
 NOTE 2 - SEVERE TO VERY SEVERE CORROSION

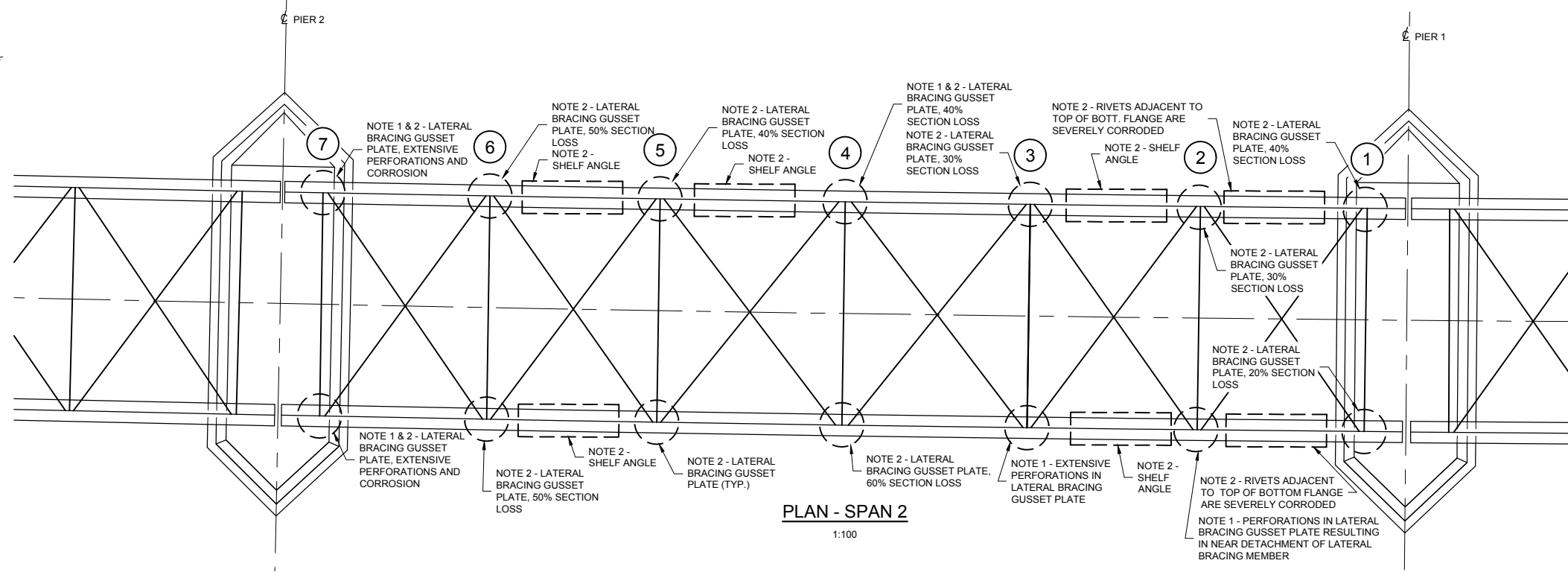

PLAN - SPAN 2
1:100

-NORTH-

-SOUTH-

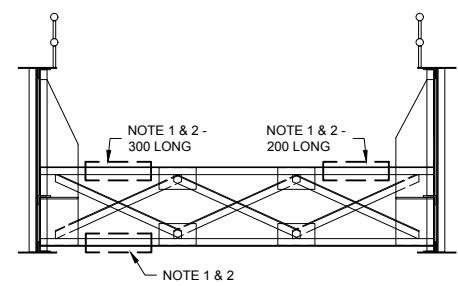

CROSS-FRAME 2-1
1:75

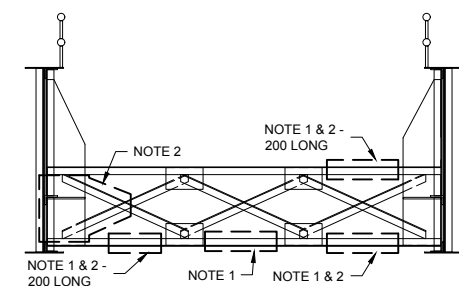

CROSS-FRAME 2-2
1:75

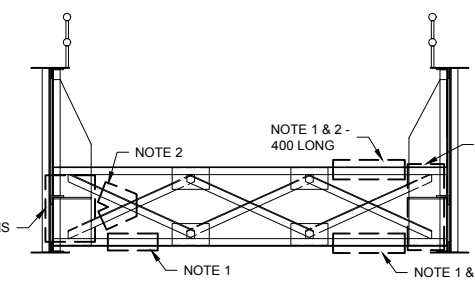

CROSS-FRAME 2-3
1:75

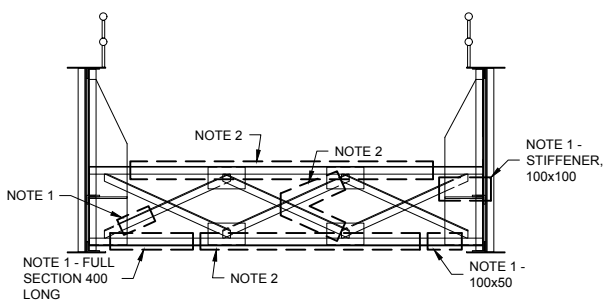

CROSS-FRAME 2-4
1:75

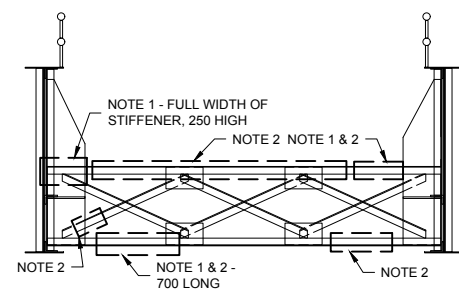

CROSS-FRAME 2-5
1:75

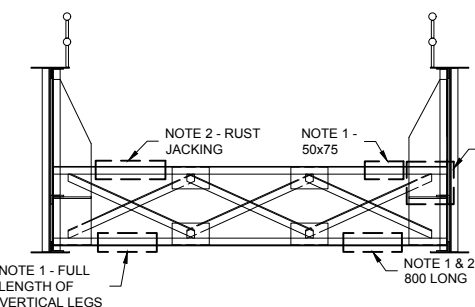

CROSS-FRAME 2-6
1:75

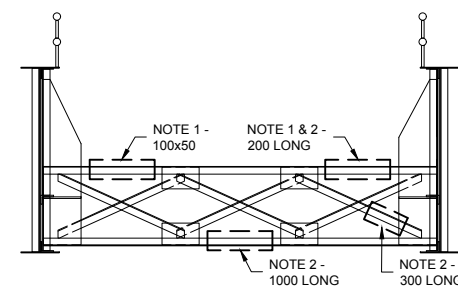

CROSS-FRAME 2-7
1:75

NOTE:
CROSS-FRAME ELEMENTS BELOW THE TIMBER DECK ARE IN POOR CONDITION ON ACCOUNT OF SEVERE TO VERY SEVERE CORROSION THROUGHOUT.



Contract #: ISD17-7087

**OLD RAILWAY RIDEAU
 RIVER PEDESTRIAN BRIDGE
 STRUCTURE No. 018600
 DETAILED CONDITION ASSESSMENT**

SPAN 2 DETERIORATION

Drawing Frame: 790mm x 540mm City of Ottawa, 2008 (Rev.0)
 Plot Date: Monday, November 19, 2018 11:22:36 AM
 Thursday, October 25, 2018 1:50:15 PM
 Consultant's Information: H:\B0762600\1000 - Old Railway Rideau River Ped Bridge\Drawings\SN018600-Condition Assessment\02-09-Structural Steel\ldgfl Saved

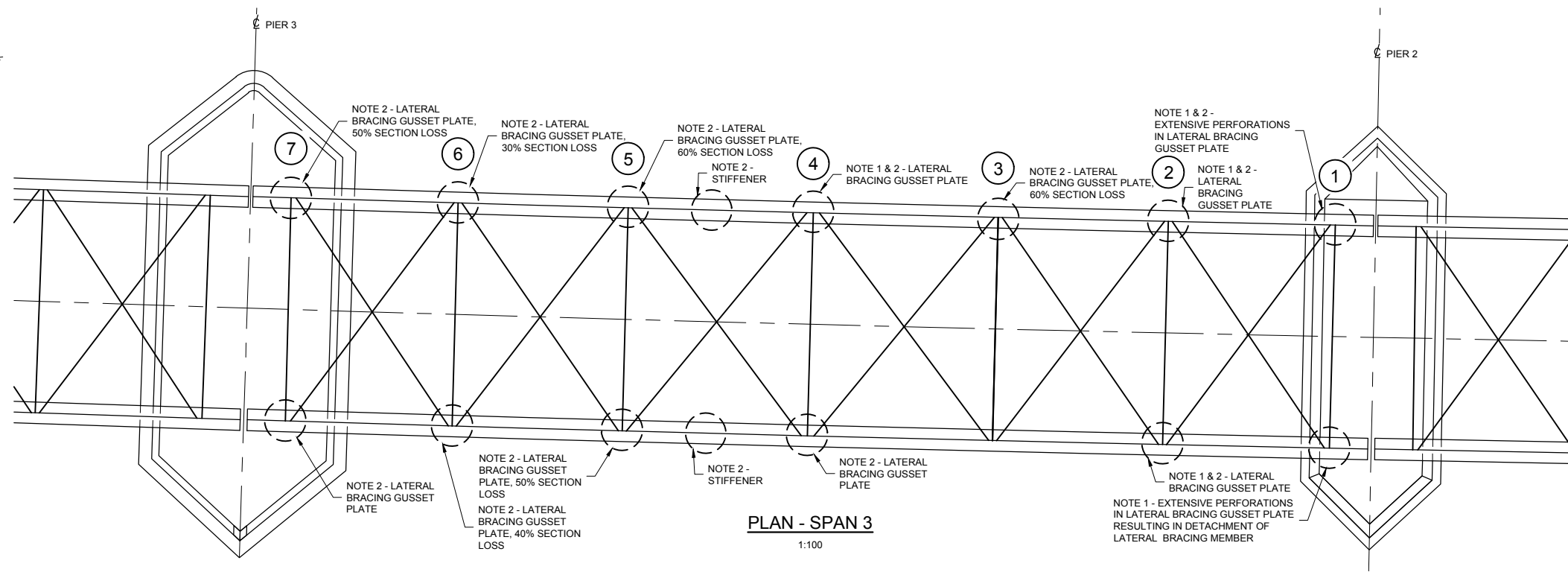

LEGEND:
 CROSS-FRAME 2-3 - CROSS-FRAME (SPAN)-(FRAME NO.)
 NOTE 1 - STRUCTURAL STEEL PERFORATIONS
 NOTE 2 - SEVERE TO VERY SEVERE CORROSION

-NORTH-

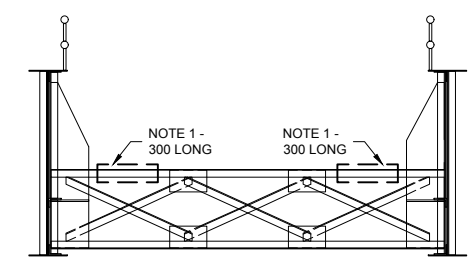

CROSS-FRAME 3-1
1:75

-SOUTH-

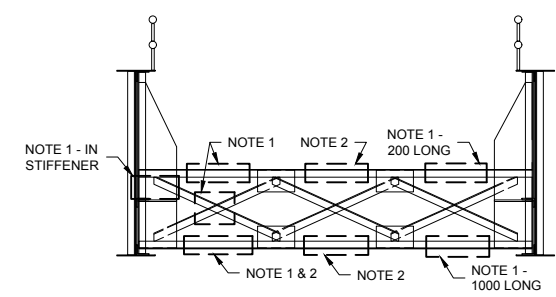

CROSS-FRAME 3-2
1:75

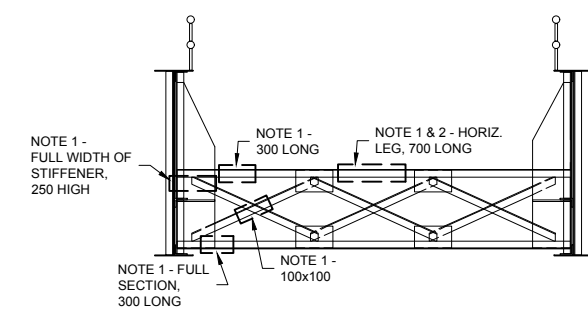

CROSS-FRAME 3-3
1:75

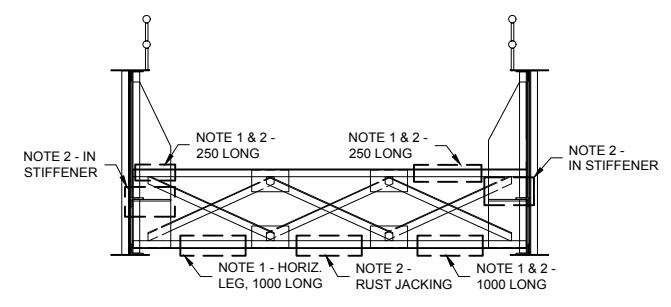

CROSS-FRAME 3-4
1:75

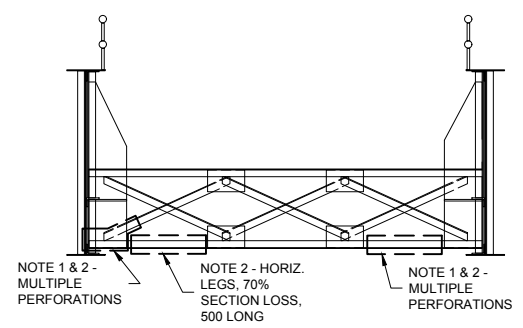

CROSS-FRAME 3-5
1:75

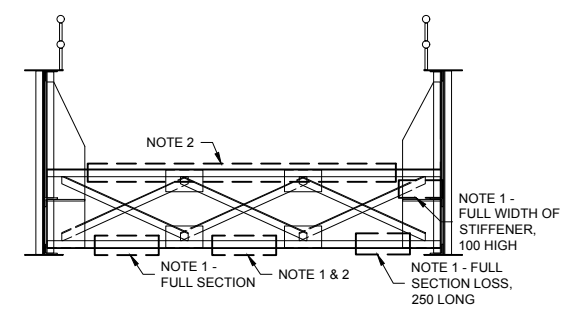

CROSS-FRAME 3-6
1:75

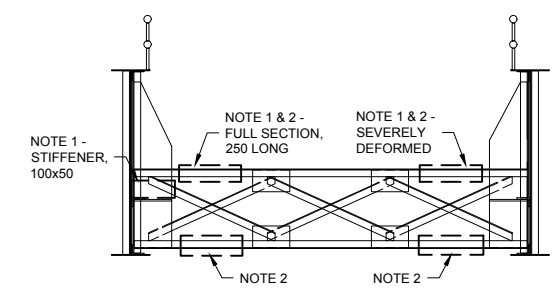

CROSS-FRAME 3-7
1:75

NOTE:
 CROSS-FRAME ELEMENTS BELOW THE TIMBER DECK ARE IN POOR CONDITION ON ACCOUNT OF SEVERE TO VERY SEVERE CORROSION THROUGHOUT.



Contract #: ISD17-7087

**OLD RAILWAY RIDEAU
 RIVER PEDESTRIAN BRIDGE
 STRUCTURE No. 018600
 DETAILED CONDITION ASSESSMENT**

SPAN 3 DETERIORATION

Drawing Frame: 730mm x 54mm City of Ottawa, 2008 (Rev.0)
 Plot Date: Monday, November 19, 2018 11:22:39 AM
 Thursday, October 25, 2018 1:01:15 PM
 Consultant's Information: H:\CO-762600\1000 - Old Railway Rideau River Ped Bridge\Drawings\SN018600-Condition Assessment\02-09-Structural Steel\dwg\Save.dwg



LEGEND:
 CROSS-FRAME 2-3 - CROSS-FRAME (SPAN)-(FRAME NO.)
 NOTE 1 - STRUCTURAL STEEL PERFORATIONS
 NOTE 2 - SEVERE TO VERY SEVERE CORROSION

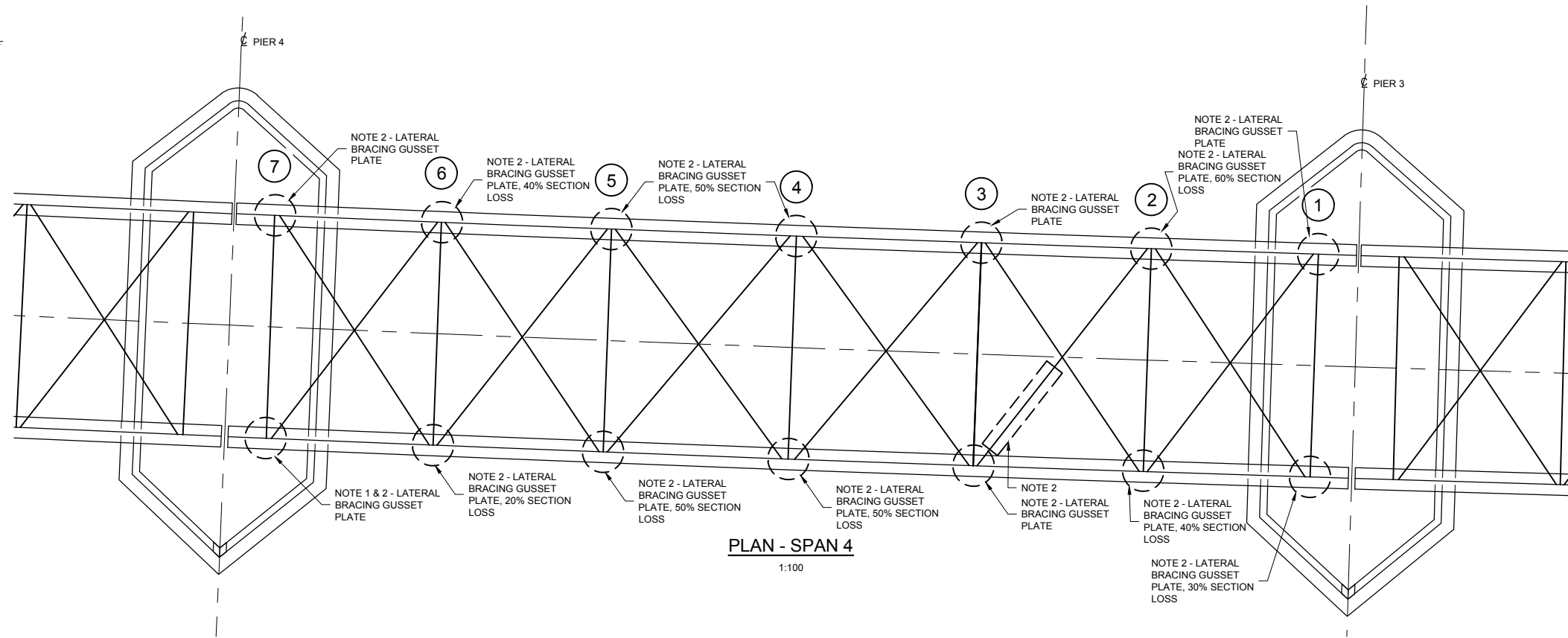

-NORTH-

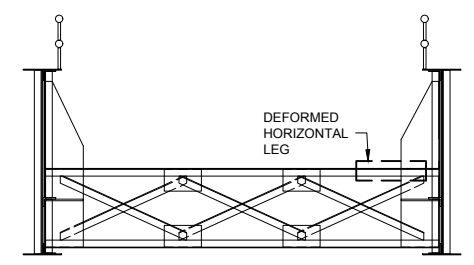

CROSS-FRAME 4-1
1:75

-SOUTH-

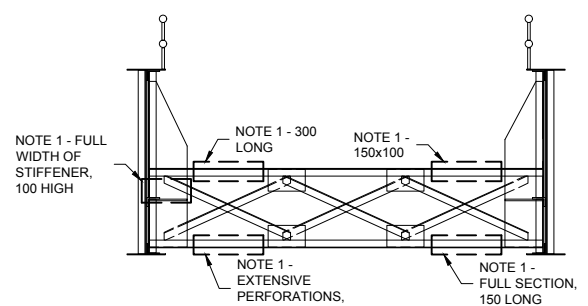

CROSS-FRAME 4-2
1:75

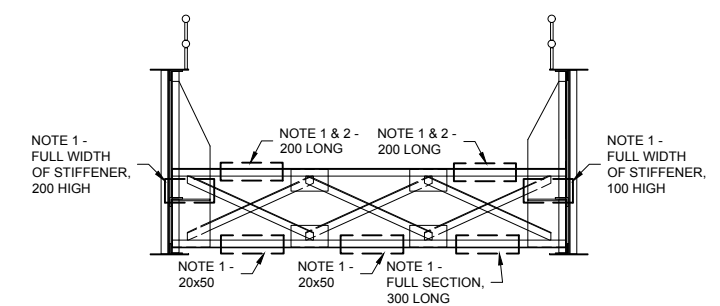

CROSS-FRAME 4-3
1:75

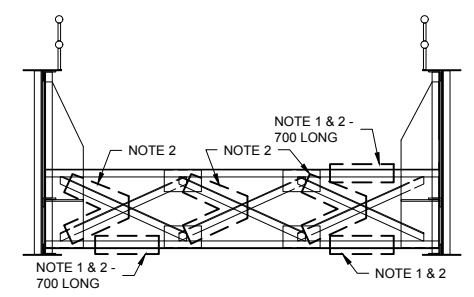

CROSS-FRAME 4-4
1:75

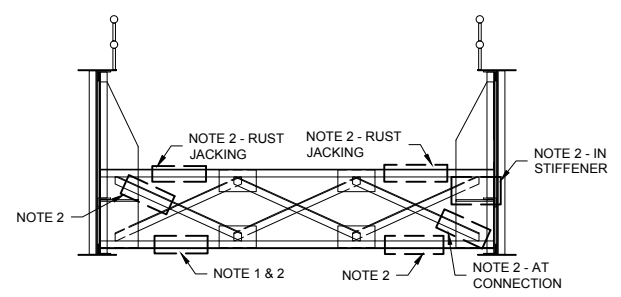

CROSS-FRAME 4-5
1:75

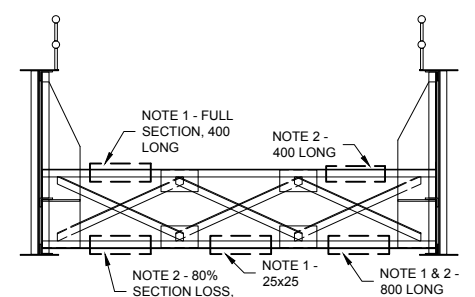

CROSS-FRAME 4-6
1:75

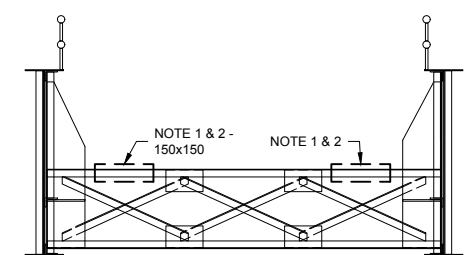

CROSS-FRAME 4-7
1:75

NOTE:
CROSS-FRAME ELEMENTS BELOW THE TIMBER DECK ARE IN POOR CONDITION ON ACCOUNT OF SEVERE TO VERY SEVERE CORROSION THROUGHOUT.



Contract #: ISD17-7087

**OLD RAILWAY RIDEAU
 RIVER PEDESTRIAN BRIDGE
 STRUCTURE No. 018600
 DETAILED CONDITION ASSESSMENT**

SPAN 4 DETERIORATION



LEGEND:
 CROSS-FRAME 2-3 - CROSS-FRAME (SPAN)-(FRAME NO.)
 NOTE 1 - STRUCTURAL STEEL PERFORATIONS
 NOTE 2 - SEVERE TO VERY SEVERE CORROSION

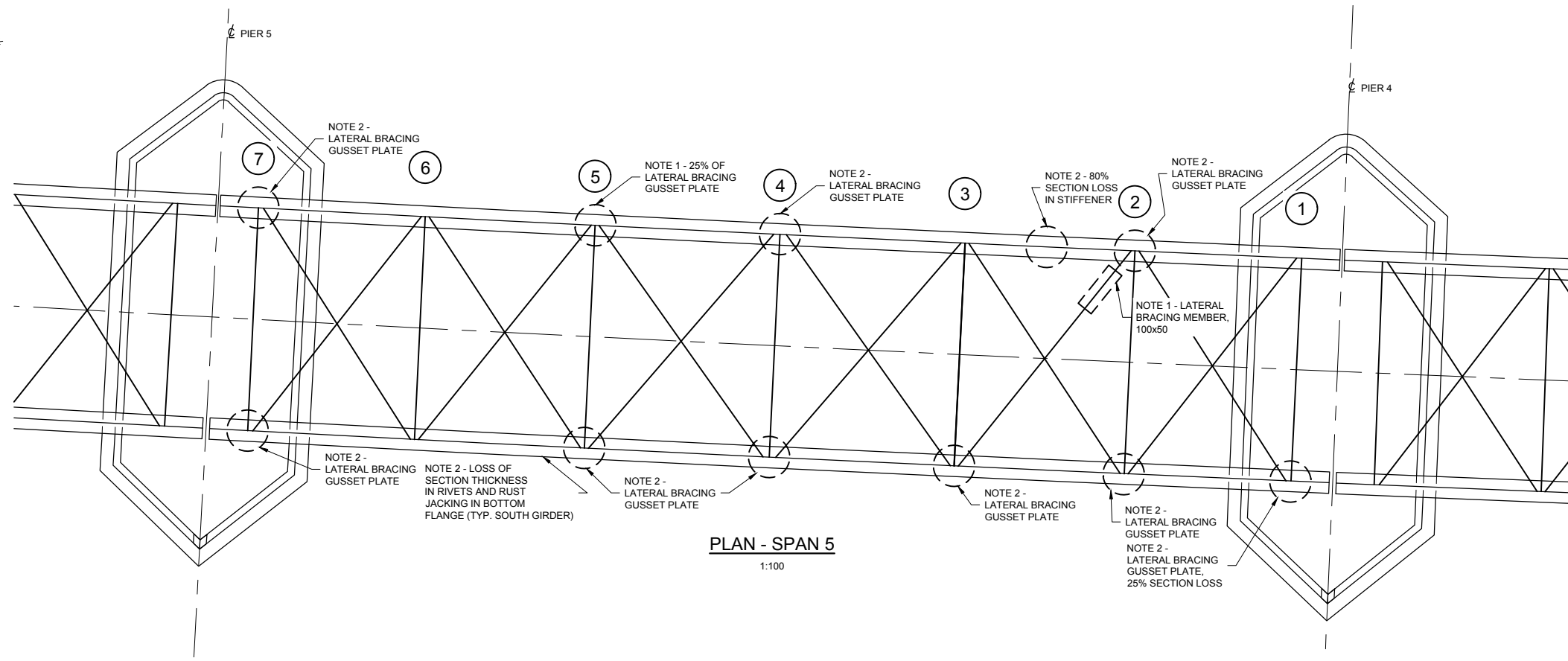

-NORTH-

-SOUTH-

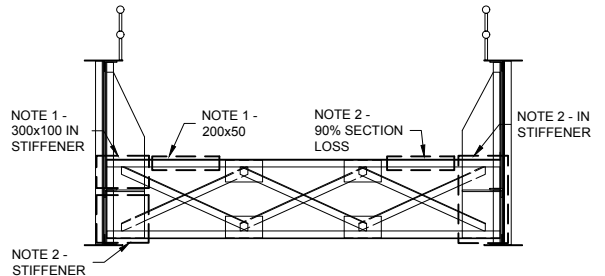
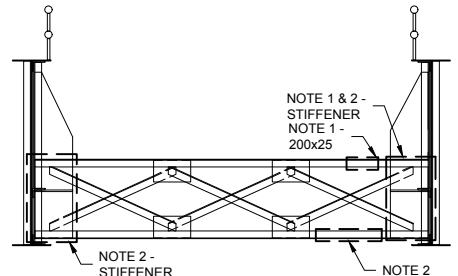
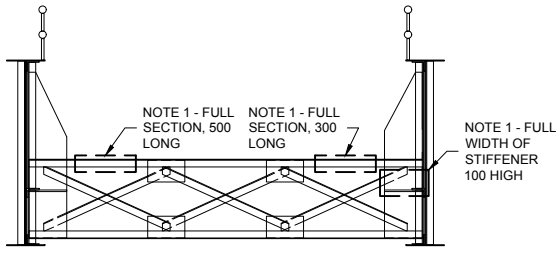
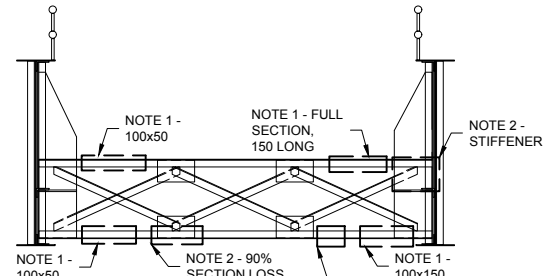
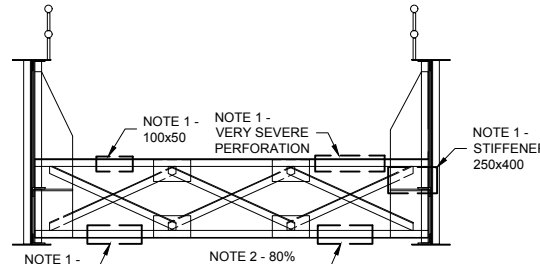
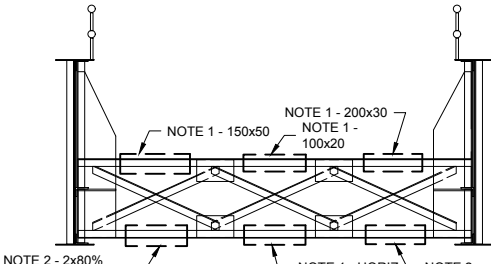
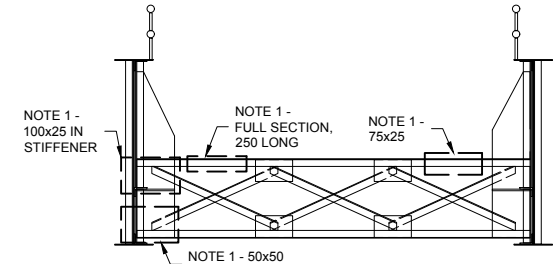

PARSONS

NOTE: CROSS-FRAME ELEMENTS BELOW THE TIMBER DECK ARE IN POOR CONDITION ON ACCOUNT OF SEVERE TO VERY SEVERE CORROSION THROUGHOUT.



Contract #: ISD17-7087

**OLD RAILWAY RIDEAU
 RIVER PEDESTRIAN BRIDGE
 STRUCTURE No. 018600
 DETAILED CONDITION ASSESSMENT**

SPAN 5 DETERIORATION

476506

NOVEMBER 2018

Sheet No. 06

Drawing Frame: 790mm x 54mm City of Ottawa, 2008 (Rev.0)
 Plot Date: Monday, November 19, 2018 11:22:45 AM
 Thursday, October 25, 2018 1:01:15 PM
 Consultant's Information: H:\BO\762600\1000 - Old Railway Rideau River Ped Bridge\Drawings\SN018600-Condition Assessment\02-09-Structural Steel\Drawings\Save



LEGEND:
 CROSS-FRAME 2-3 - CROSS-FRAME (SPAN)-(FRAME NO.)
 NOTE 1 - STRUCTURAL STEEL PERFORATIONS
 NOTE 2 - SEVERE TO VERY SEVERE CORROSION

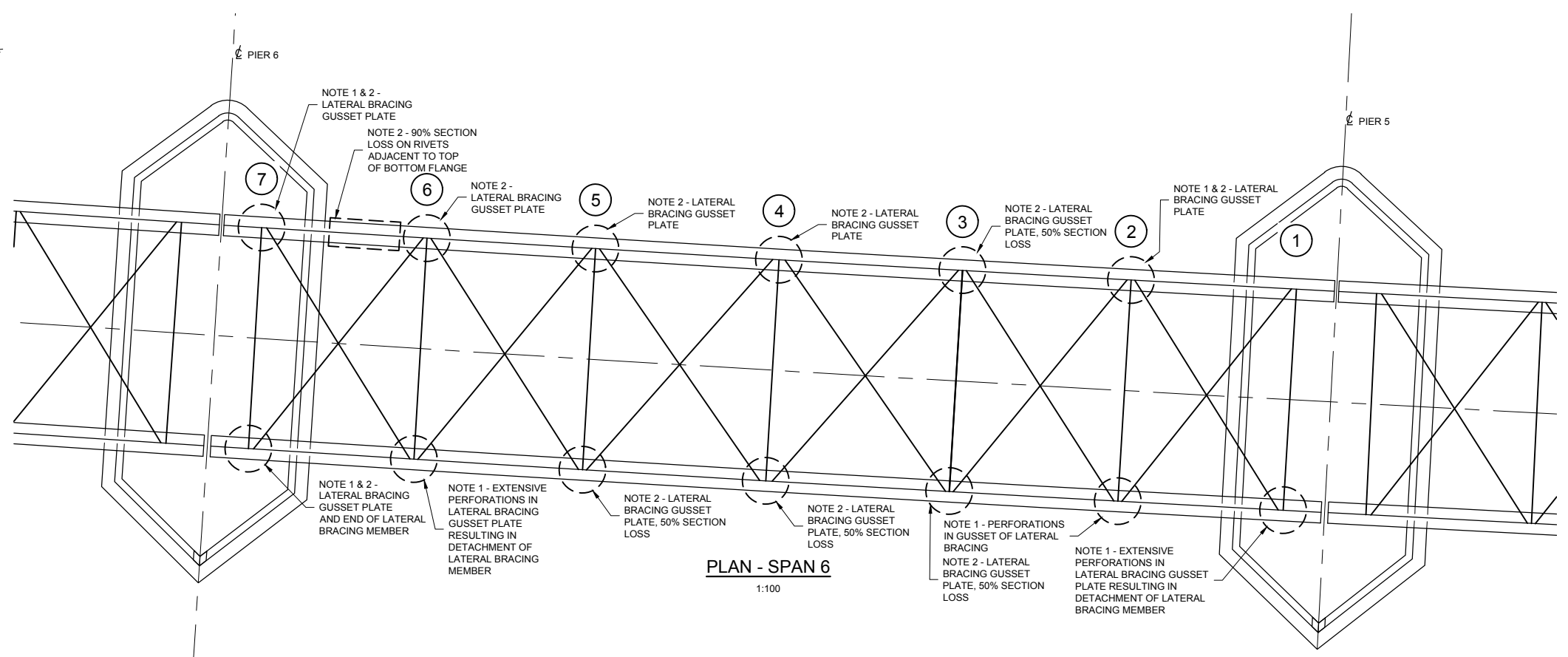

-NORTH-

-SOUTH-

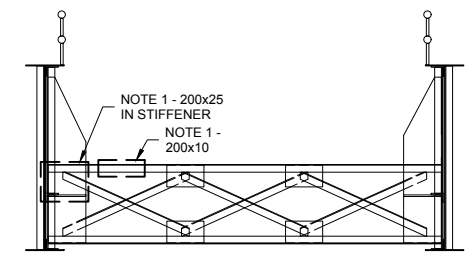

CROSS-FRAME 6-1
1:75

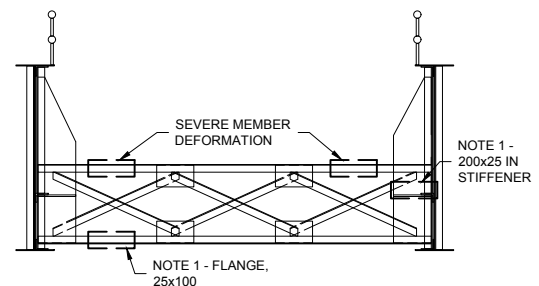

CROSS-FRAME 6-2
1:75

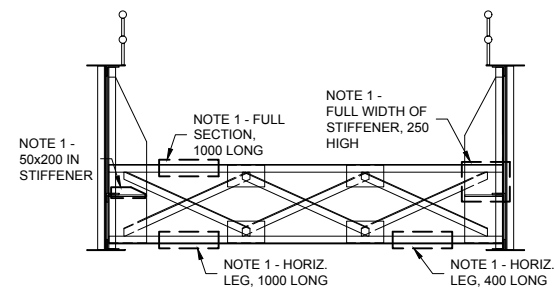

CROSS-FRAME 6-3
1:75

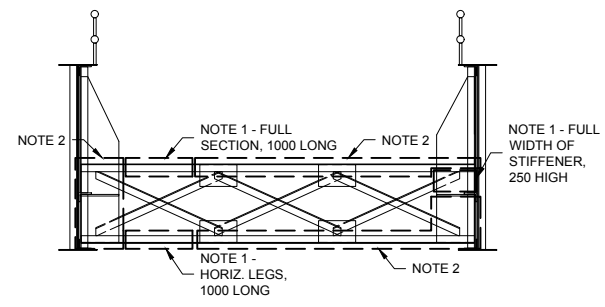

CROSS-FRAME 6-4
1:75

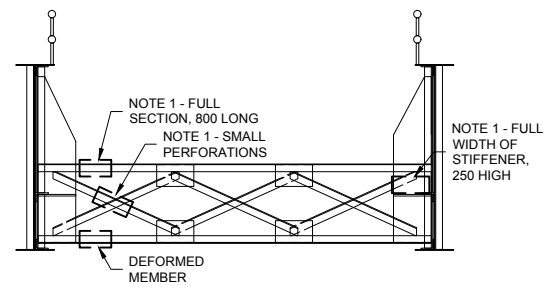

CROSS-FRAME 6-5
1:75

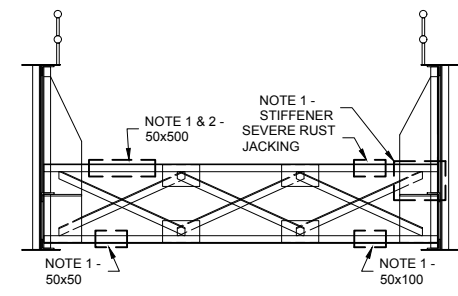

CROSS-FRAME 6-6
1:75

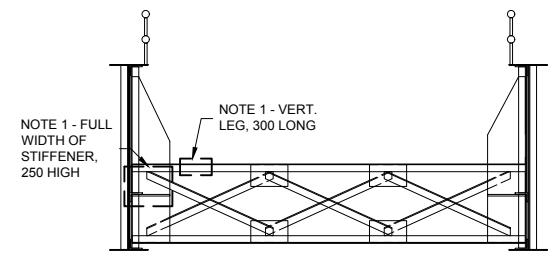

CROSS-FRAME 6-7
1:75

NOTE:
CROSS-FRAME ELEMENTS BELOW THE TIMBER DECK ARE IN POOR CONDITION ON ACCOUNT OF SEVERE TO VERY SEVERE CORROSION THROUGHOUT.



Contract #: ISD17-7087

**OLD RAILWAY RIDEAU
 RIVER PEDESTRIAN BRIDGE
 STRUCTURE No. 018600
 DETAILED CONDITION ASSESSMENT**

SPAN 6 DETERIORATION

Drawing Frame: 790mm x 54mm City of Ottawa, 2008 (Rev.0)
 Plot Date: Monday, November 19, 2018 11:22:47 AM
 Thursday, October 25, 2018 1:01:15 PM
 Consultant's Information: H:\BO\762601\000 - Old Railway Rideau River Ped Bridge\Drawings\SN018600-Condition Assessment\02-09-Structural Steel\Detail Saved



LEGEND:
 CROSS-FRAME 2-3 - CROSS-FRAME (SPAN)-(FRAME NO.)
 NOTE 1 - STRUCTURAL STEEL PERFORATIONS
 NOTE 2 - SEVERE TO VERY SEVERE CORROSION

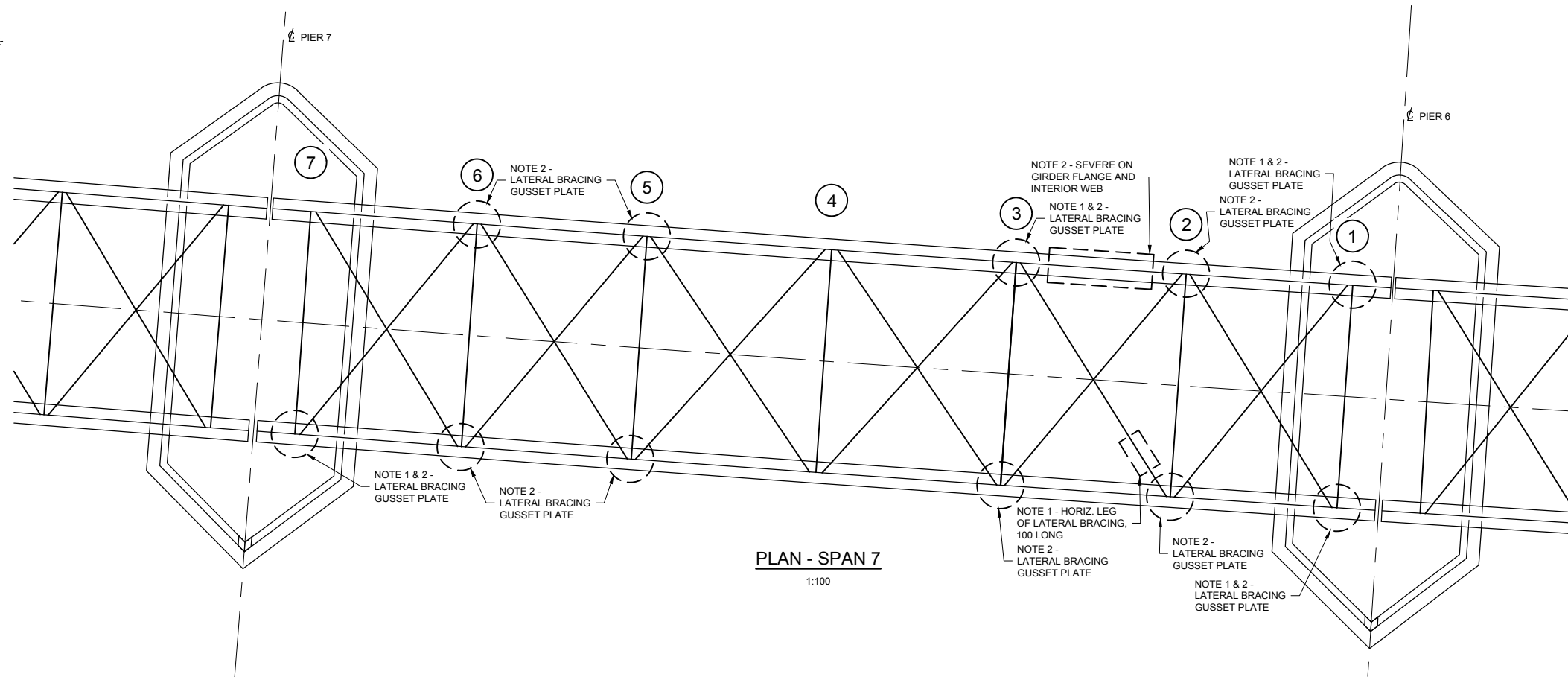

NORTH-

SOUTH-

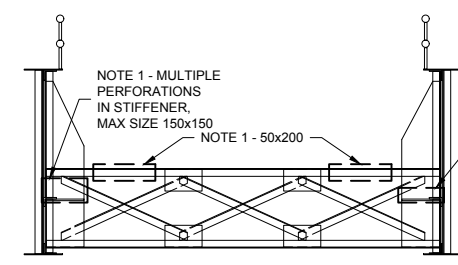

CROSS-FRAME 7-1
1:75

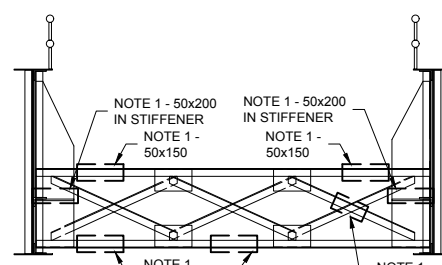

CROSS-FRAME 7-2
1:75

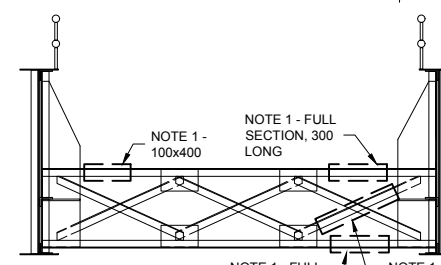

CROSS-FRAME 7-3
1:75

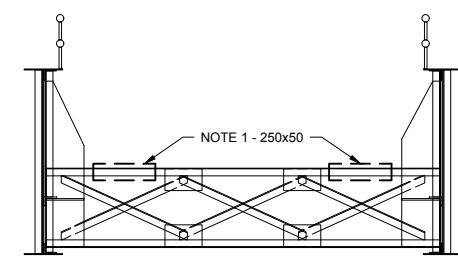

CROSS-FRAME 7-4
1:75

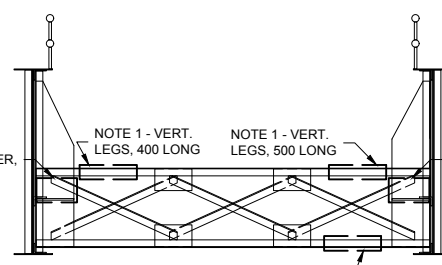

CROSS-FRAME 7-5
1:75

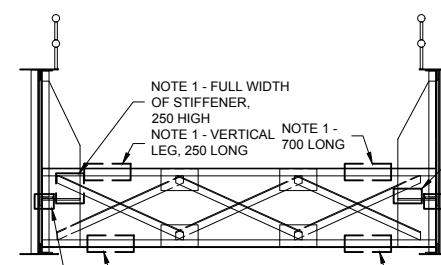

CROSS-FRAME 7-6
1:75

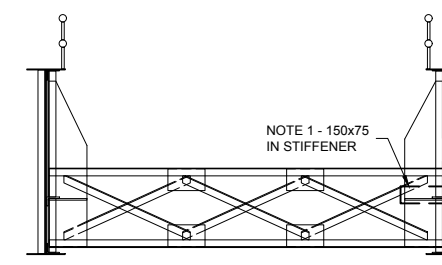

CROSS-FRAME 7-7
1:75

NOTE:
CROSS-FRAME ELEMENTS BELOW THE TIMBER DECK ARE IN POOR CONDITION ON ACCOUNT OF SEVERE TO VERY SEVERE CORROSION THROUGHOUT.



Contract #: ISD17-7087

**OLD RAILWAY RIDEAU
 RIVER PEDESTRIAN BRIDGE
 STRUCTURE No. 018600
 DETAILED CONDITION ASSESSMENT**

SPAN 7 DETERIORATION

476506 NOVEMBER 2018 Sheet No. 08



LEGEND:
 CROSS-FRAME 2-3 - CROSS-FRAME (SPAN)-(FRAME NO.)
 NOTE 1 - STRUCTURAL STEEL PERFORATIONS
 NOTE 2 - SEVERE TO VERY SEVERE CORROSION

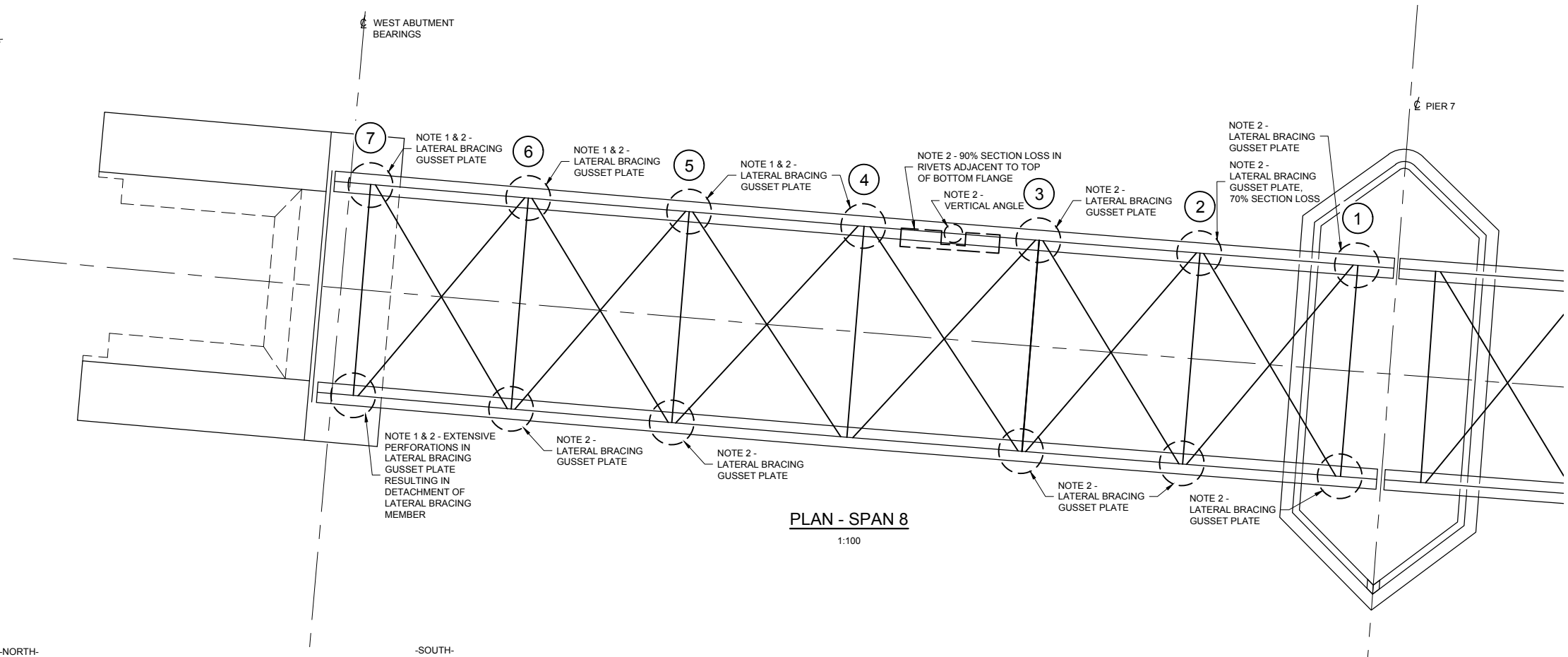

-NORTH-

-SOUTH-

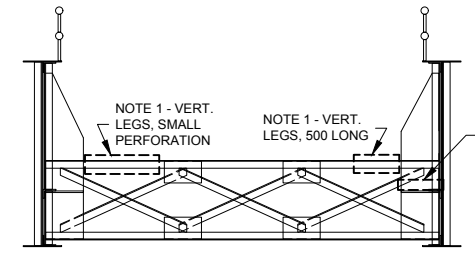

CROSS-FRAME 8-1
1:75

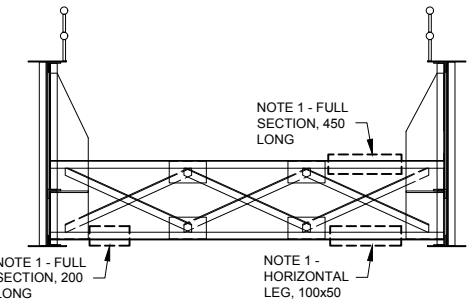

CROSS-FRAME 8-2
1:75

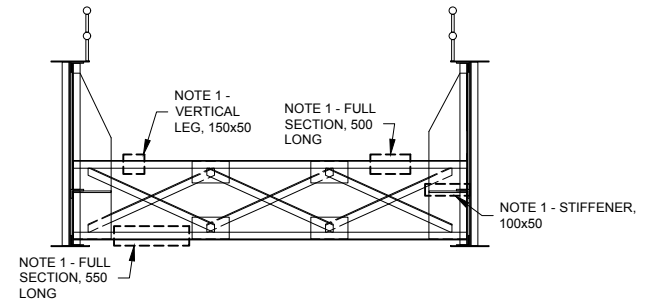

CROSS-FRAME 8-3
1:75

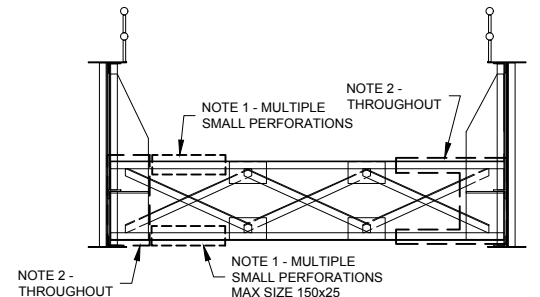

CROSS-FRAME 8-4
1:75

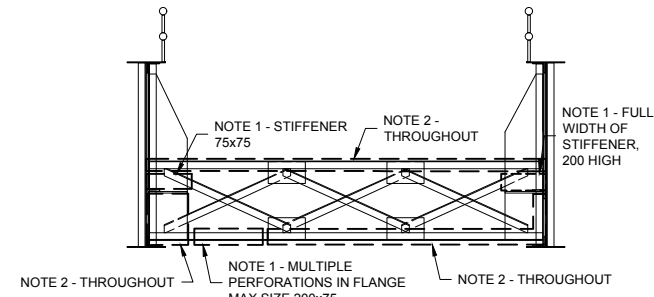

CROSS-FRAME 8-5
1:75

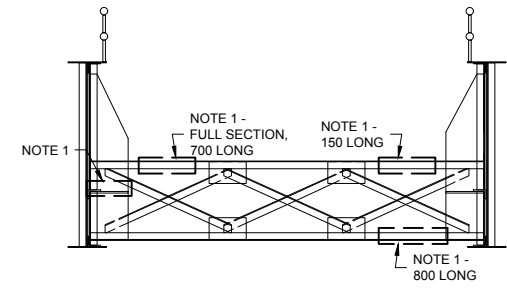

CROSS-FRAME 8-6
1:75

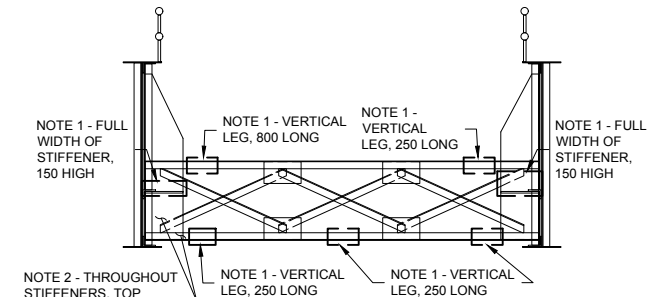

CROSS-FRAME 8-7
1:75

NOTE:
 CROSS-FRAME ELEMENTS BELOW THE TIMBER DECK ARE IN POOR CONDITION ON ACCOUNT OF SEVERE TO VERY SEVERE CORROSION THROUGHOUT.



Contract #: ISD17-7087

**OLD RAILWAY RIDEAU
 RIVER PEDESTRIAN BRIDGE
 STRUCTURE No. 018600
 DETAILED CONDITION ASSESSMENT**

SPAN 8 DETERIORATION

- LEGEND:**
- H- HAIRLINE CRACKS
 - N- NARROW CRACKS
 - M- MEDIUM CRACKS
 - W- WIDE CRACKS
 - STAINED CRACKS
 - EXPOSED REINFORCING STEEL
 - PATTERN CRACKING
 - DELAMINATIONS
 - SPALLS
 - MS MEDIUM SCALING
 - SS SEVERE SCALING
 - EROSION
 - DISINTEGRATION
 - HONEYCOMBED AREAS
 - ACCUMULATION OF DEBRIS
 - LIMITING INSPECTION

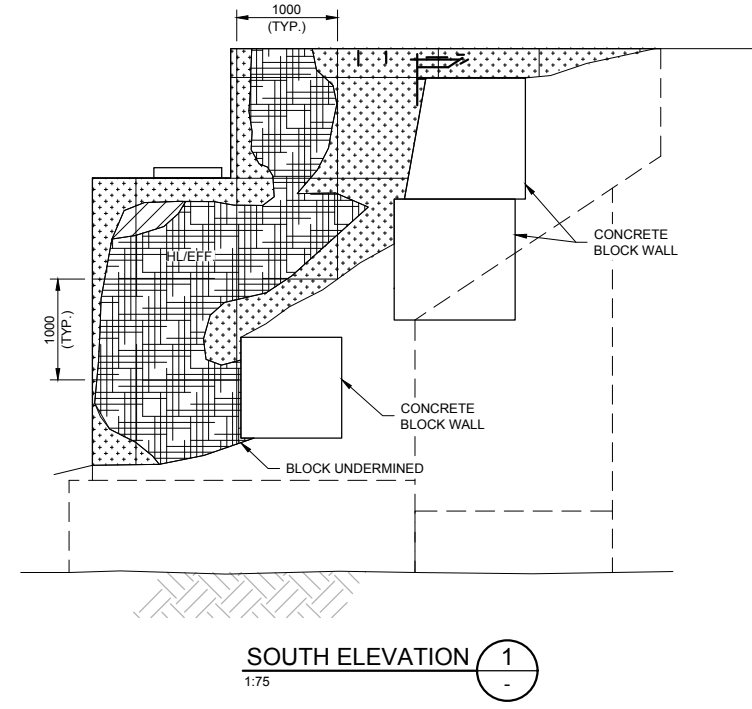
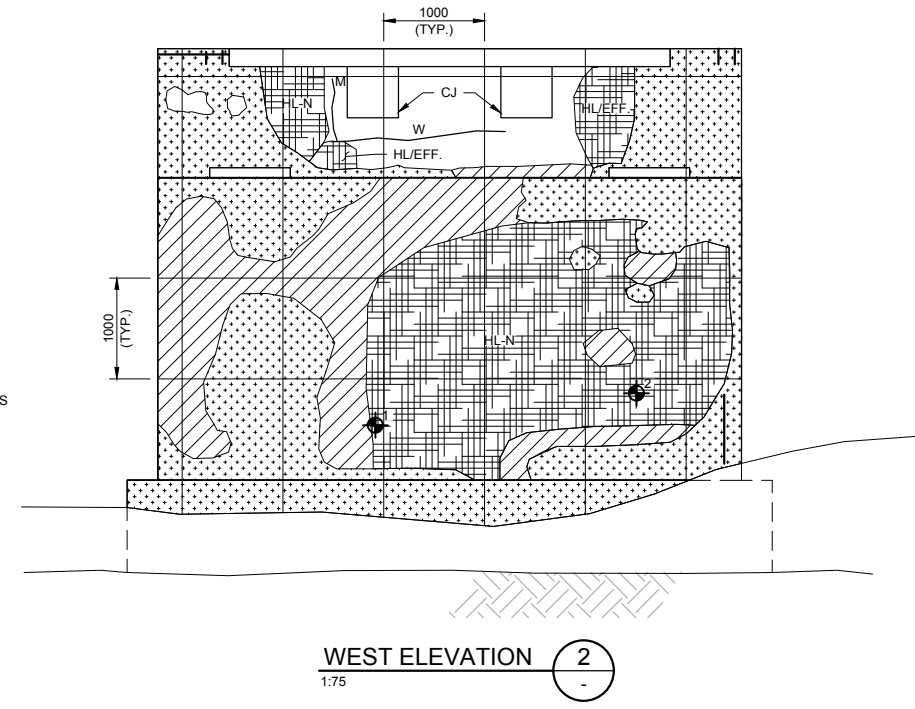
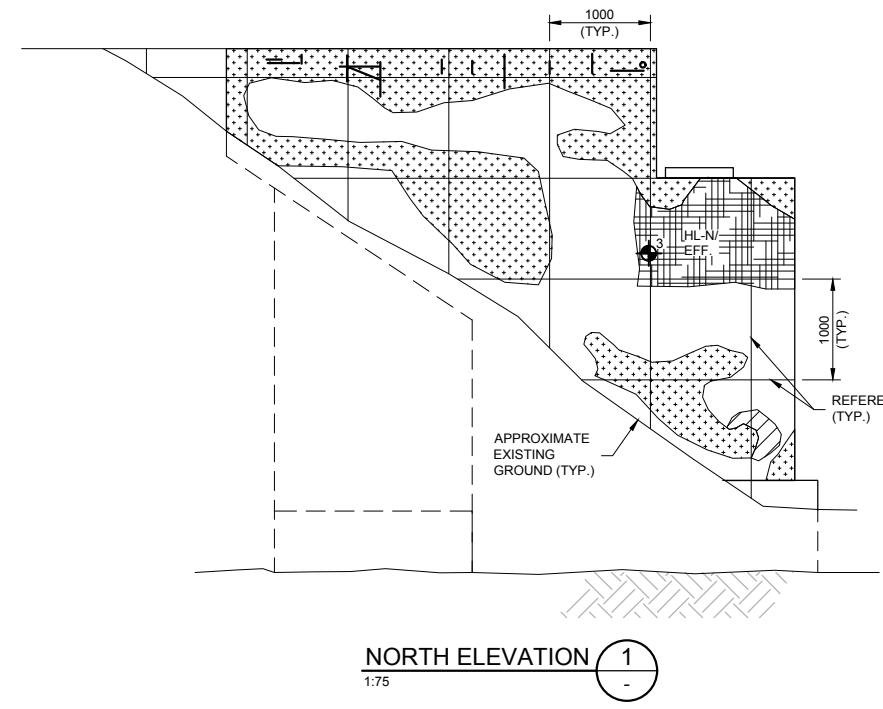
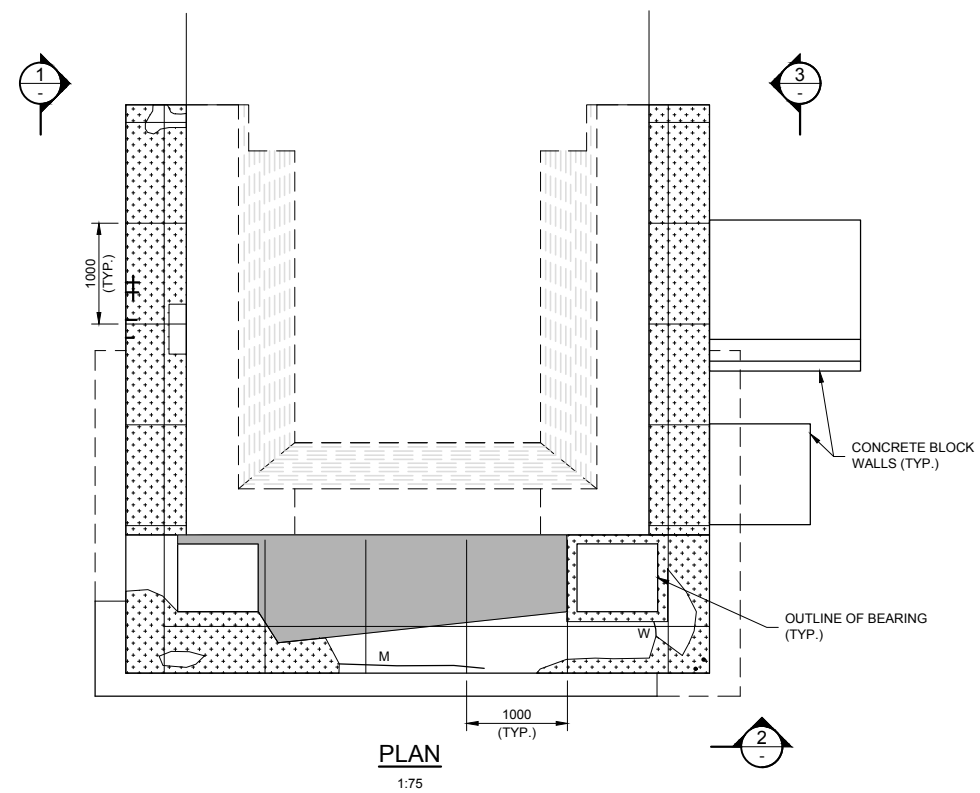

NOTE:



Contract #: ISD17-7087

**OLD RAILWAY RIDEAU
RIVER PEDESTRIAN BRIDGE
STRUCTURE No. 018600
DETAILED CONDITION ASSESSMENT**

EAST ABUTMENT DETERIORATION

476506 NOVEMBER 2018 Sheet No. 10

Drawing Frame: 790mm x 540mm x 54mm City of Ottawa, 2008 (Rev. 0)
 Plot Date: Monday, November 19, 2018 11:23:15 AM
 Tuesday, October 09, 2018 9:11:23 AM
 Consultant's Information: H:\BCO\7626001\000 - Old Railway Rideau River Ped Bridge\DKGS01 Working Drawings\SN018600-Condition Assessment\10-15-Piers & Abutments\DWG.dwg

- LEGEND:**
- H — HAIRLINE CRACKS
 - N — NARROW CRACKS
 - M — MEDIUM CRACKS
 - W — WIDE CRACKS
 - /// STAINED CRACKS
 - EXPOSED REINFORCING STEEL
 - ▧ PATTERN CRACKING
 - ▨ DELAMINATIONS
 - ⊗ SPALLS
 - MS MEDIUM SCALING
 - SS SEVERE SCALING
 - EROSION
 - DISINTEGRATION
 - HONEYCOMBED AREAS
 - ACCUMULATION OF DEBRIS
 - LIMITING INSPECTION

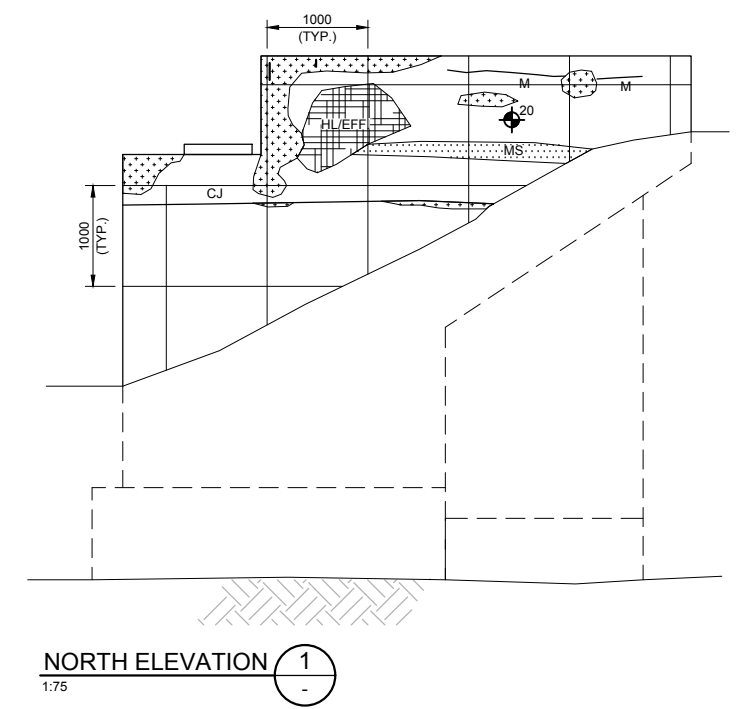
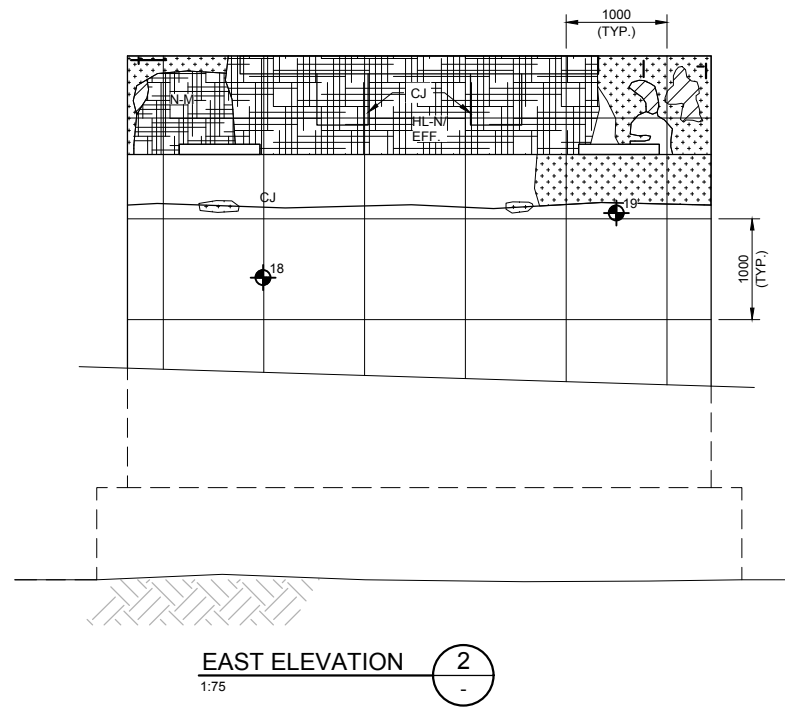
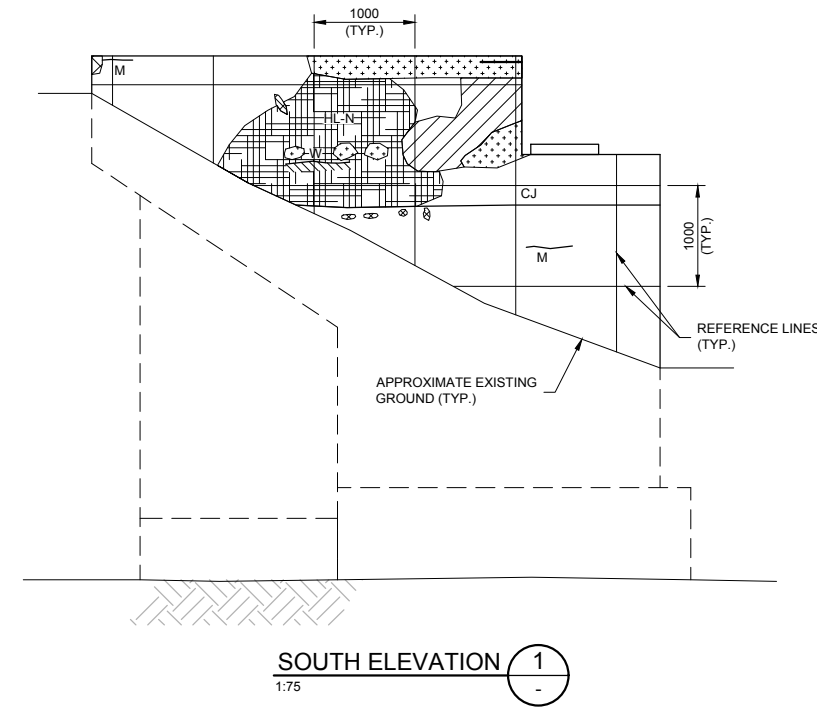
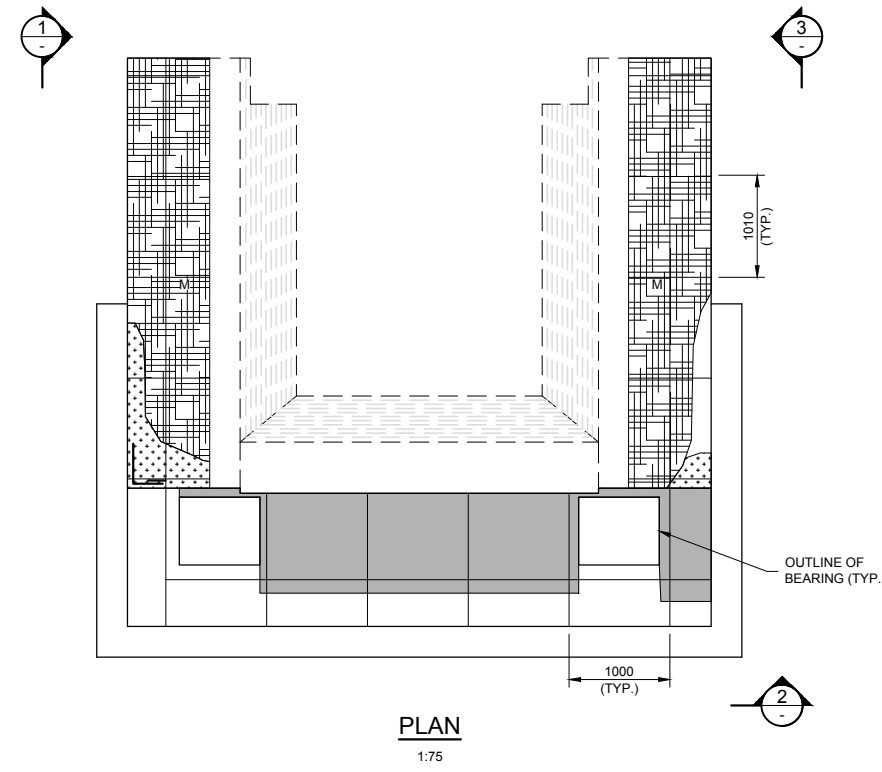

NOTE:



**OLD RAILWAY RIDEAU
 RIVER PEDESTRIAN BRIDGE
 STRUCTURE No. 018600
 DETAILED CONDITION ASSESSMENT**

WEST ABUTMENT DETERIORATION

476506	NOVEMBER 2018	Sheet No. 11
--------	---------------	--------------

Drawing Frame: 790mm x 54mm City of Ottawa, 2008 (Rev.0)
 Monday, November 19, 2018 11:23:19 AM
 Tuesday, October 09, 2018 9:11:23 AM
 Consultant's Information: H:\CO\762601\000 - Old Railway Rideau River Ped Bridge\DKGS01 Working Drawings\SN018600-Condition Assessment\10-15-Piers & Abutments\DWG.dwg
 File Date:

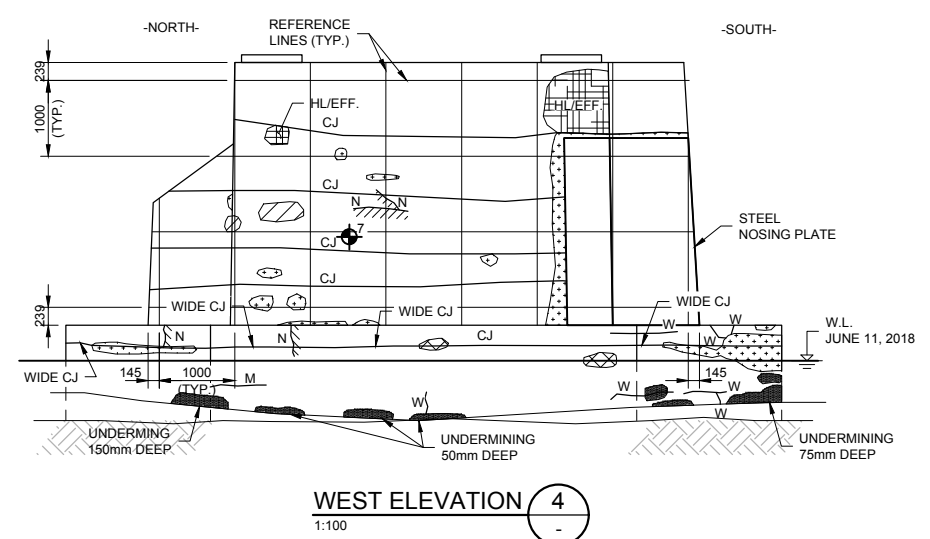
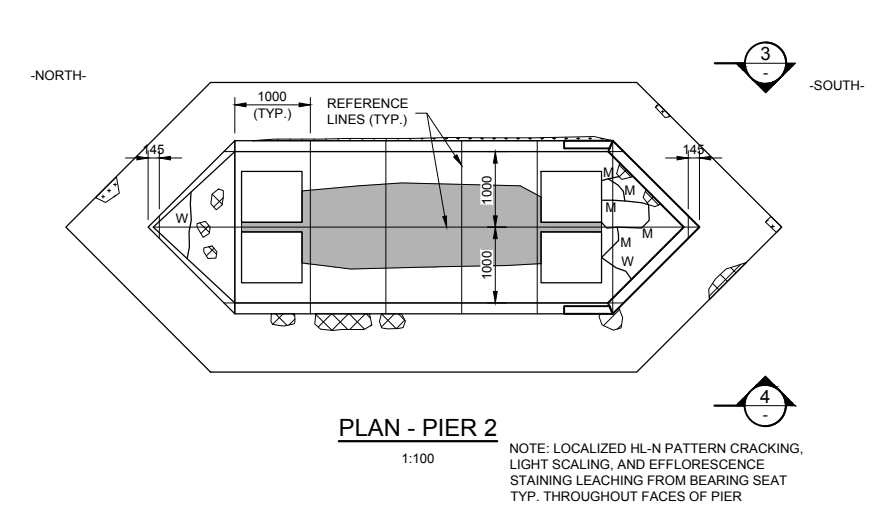
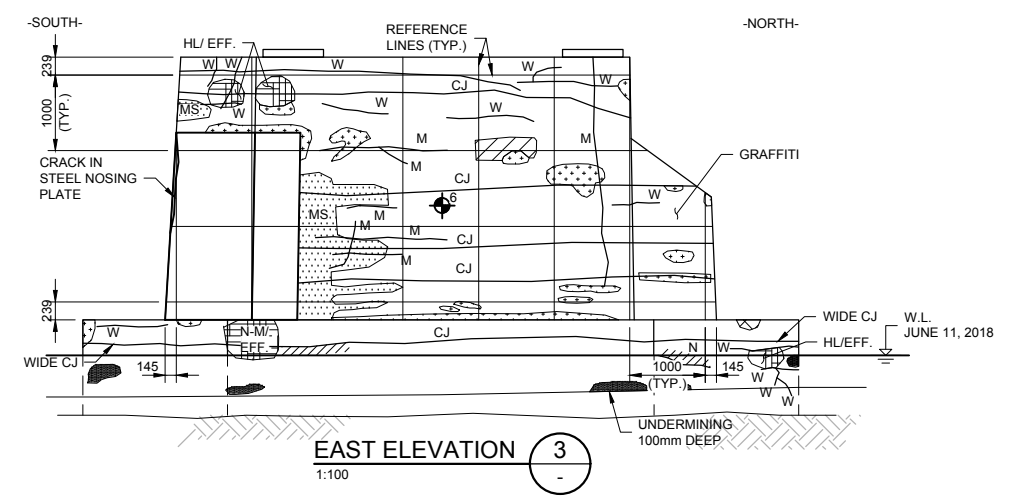
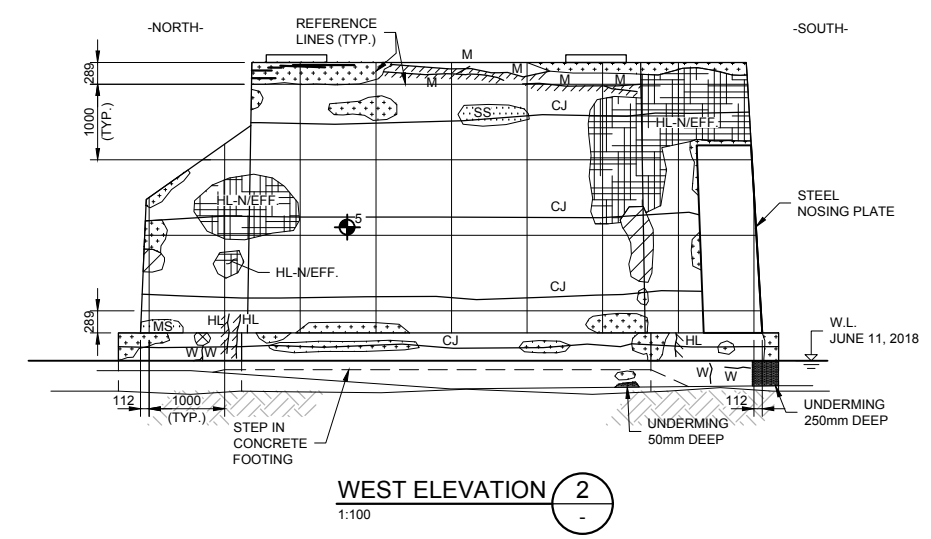
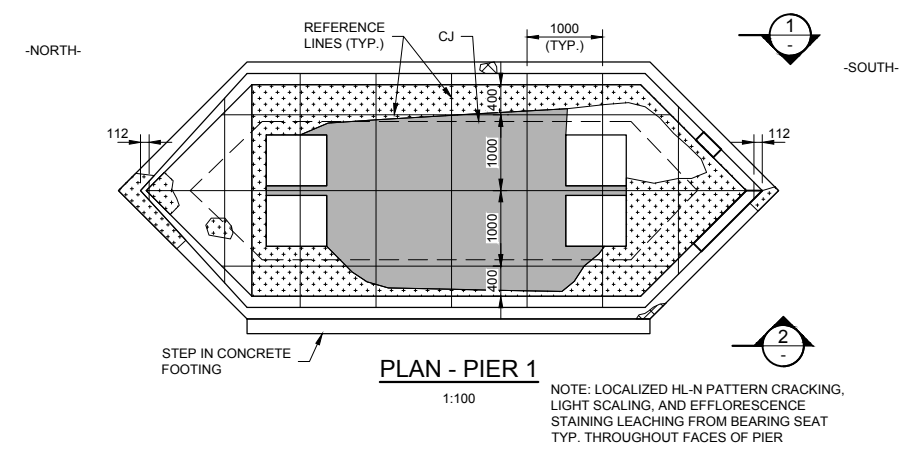
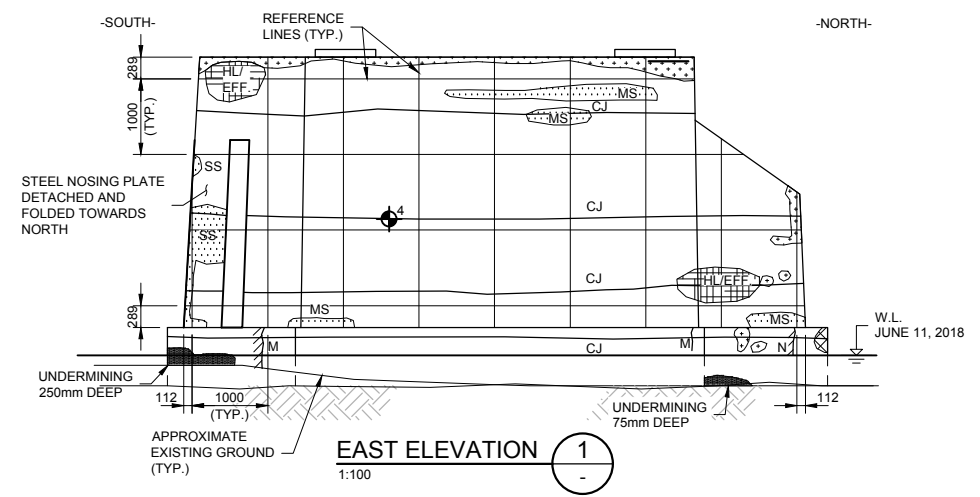

- LEGEND:**
- H — HAIRLINE CRACKS
 - N — NARROW CRACKS
 - M — MEDIUM CRACKS
 - W — WIDE CRACKS
 - /// STAINED CRACKS
 - EXPOSED REINFORCING STEEL
 - ▨ PATTERN CRACKING
 - ▧ DELAMINATIONS
 - ▩ SPALLS
 - MS MEDIUM SCALING
 - SS SEVERE SCALING
 - EROSION
 - DISINTEGRATION
 - HONEYCOMBED AREAS
 - ACCUMULATION OF DEBRIS LIMITING INSPECTION

PARSONS

NOTE:



Contract #: ISD17-7087

**OLD RAILWAY RIDEAU
 RIVER PEDESTRIAN BRIDGE
 STRUCTURE No. 018600
 DETAILED CONDITION ASSESSMENT**

PIERS 1 & 2 DETERIORATION

476506 NOVEMBER 2018 Sheet No. 12

Drawing Frame: 790mm x 540mm City of Ottawa, 2008 (Rev.0)
 Monday, November 19, 2018 11:23:22 AM
 Tuesday, October 09, 2018 9:11:23 AM
 Consultant's Information: H:\BO\762601\000 - Old Railway Rideau River Ped Bridge\DWGS\01 Working Drawings\SN018600-Condition Assessment\10-15-Piers & Abutments\DWG.dwg
 Plot Date:

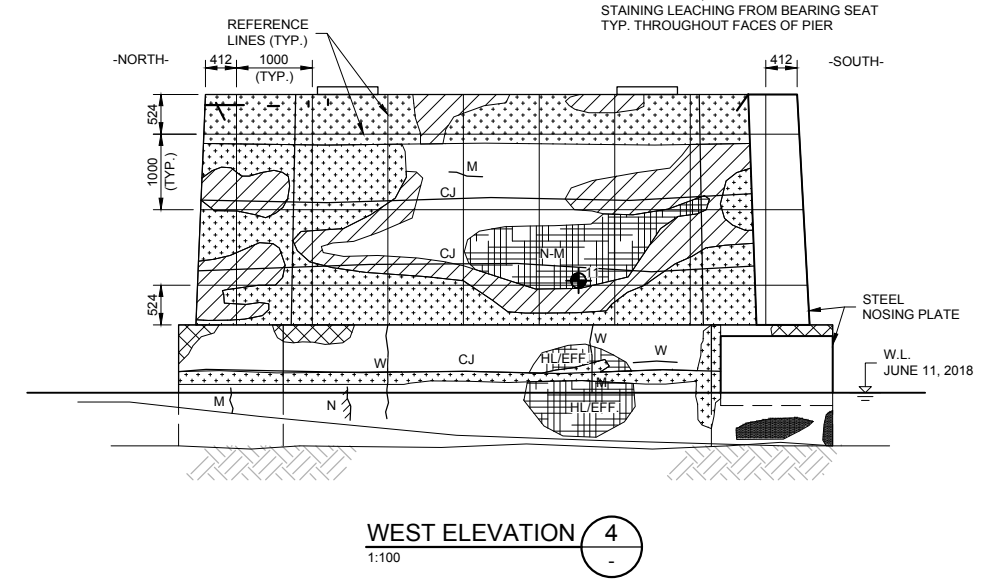
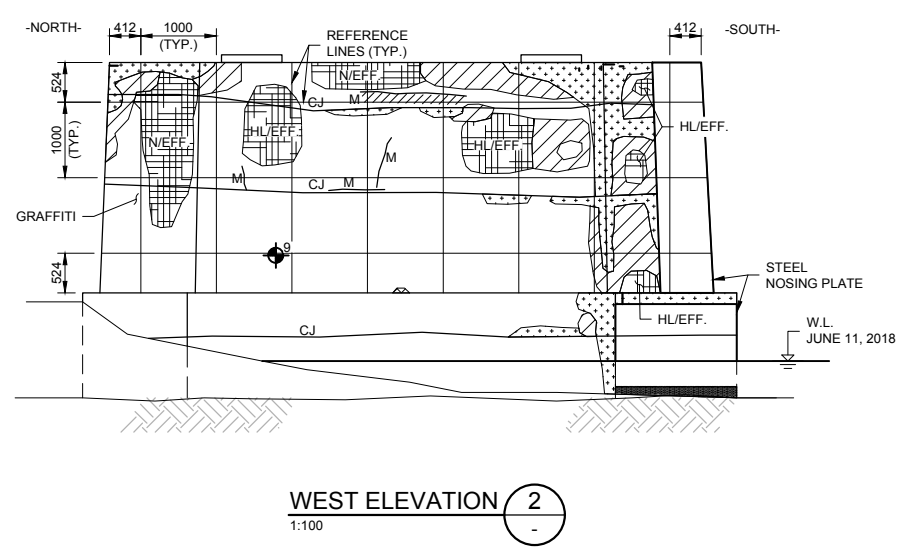
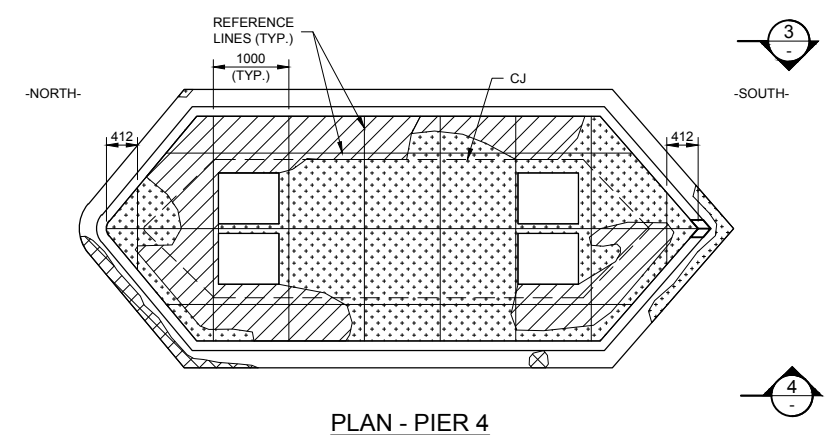
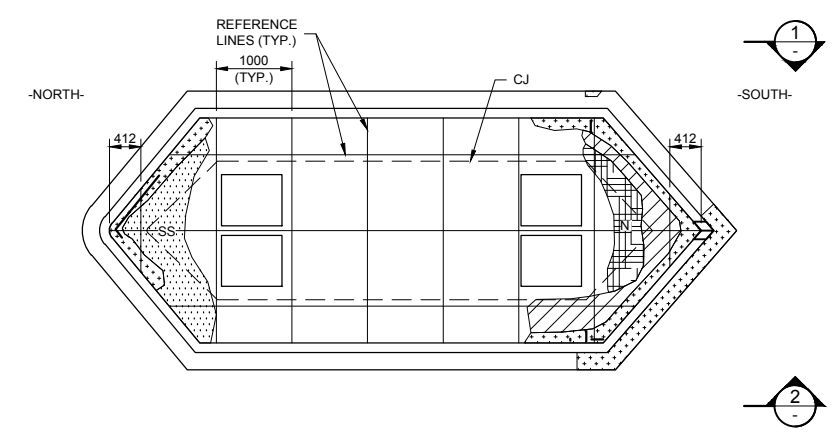
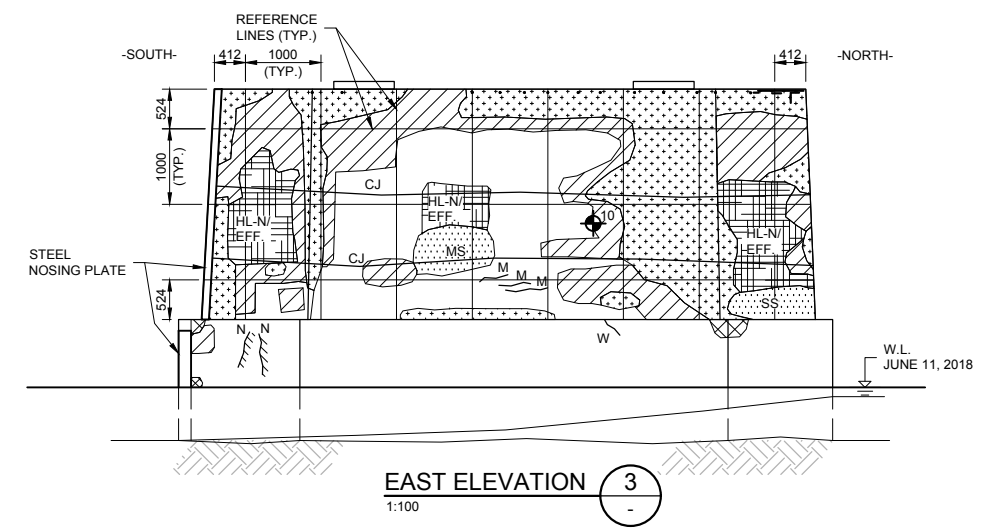
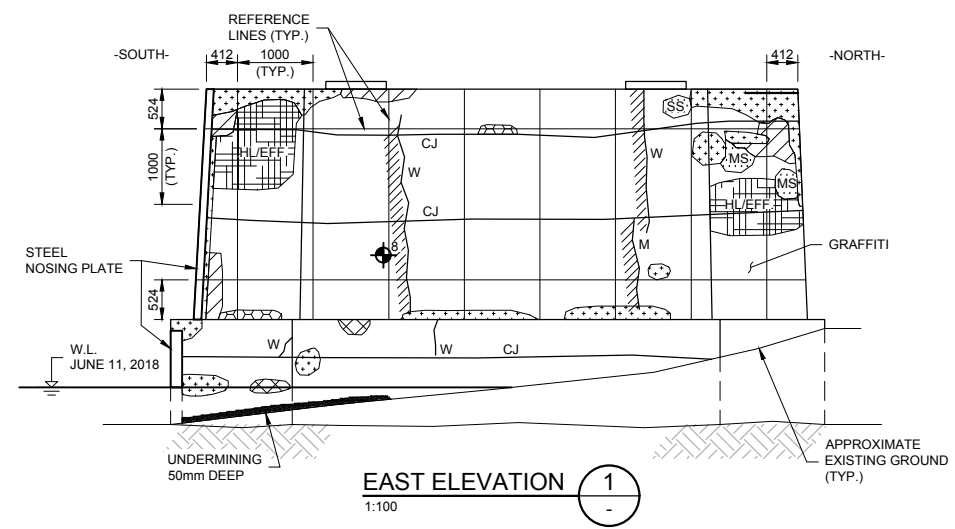

- LEGEND:**
- H HAIRLINE CRACKS
 - N NARROW CRACKS
 - M MEDIUM CRACKS
 - W WIDE CRACKS
 - /// STAINED CRACKS
 - EXPOSED REINFORCING STEEL
 - ▨ PATTERN CRACKING
 - ▧ DELAMINATIONS
 - ⊗ SPALLS
 - MS MEDIUM SCALING
 - SS SEVERE SCALING
 - EROSION
 - ◻ DISINTEGRATION
 - ◻ HONEYCOMBED AREAS
 - ◻ ACCUMULATION OF DEBRIS
 - ◻ LIMITING INSPECTION

NOTE: LOCALIZED HL-N PATTERN CRACKING, LIGHT SCALING, AND EFFLORESCENCE STAINING LEACHING FROM BEARING SEAT TYP. THROUGHOUT FACES OF PIER

NOTE: LOCALIZED HL-N PATTERN CRACKING, LIGHT SCALING, AND EFFLORESCENCE STAINING LEACHING FROM BEARING SEAT TYP. THROUGHOUT FACES OF PIER

NOTE:

PARSONS



Contract #: ISD17-7087

**OLD RAILWAY RIDEAU
 RIVER PEDESTRIAN BRIDGE
 STRUCTURE No. 018600
 DETAILED CONDITION ASSESSMENT**

PIERS 3 & 4 DETERIORATION

476506 NOVEMBER 2018 Sheet No. 13

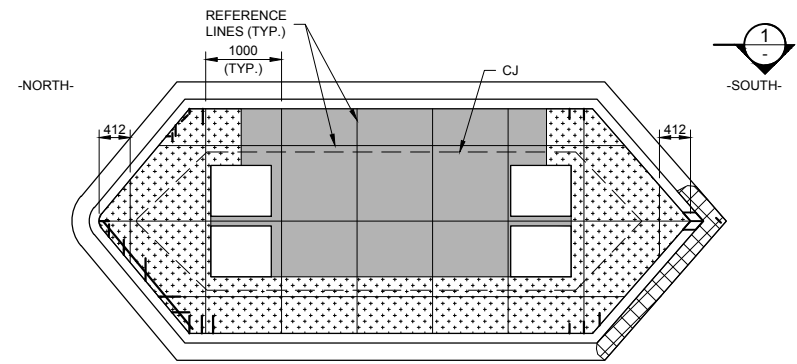
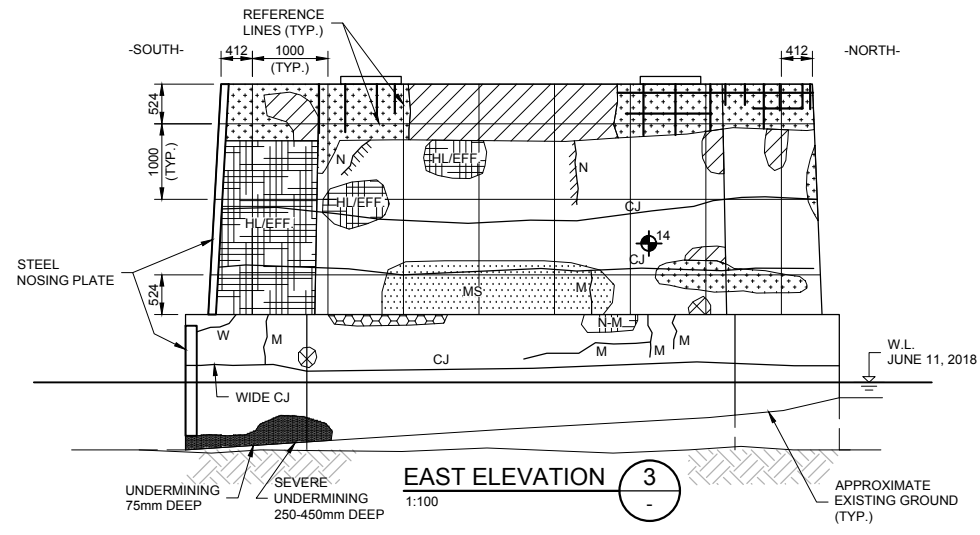
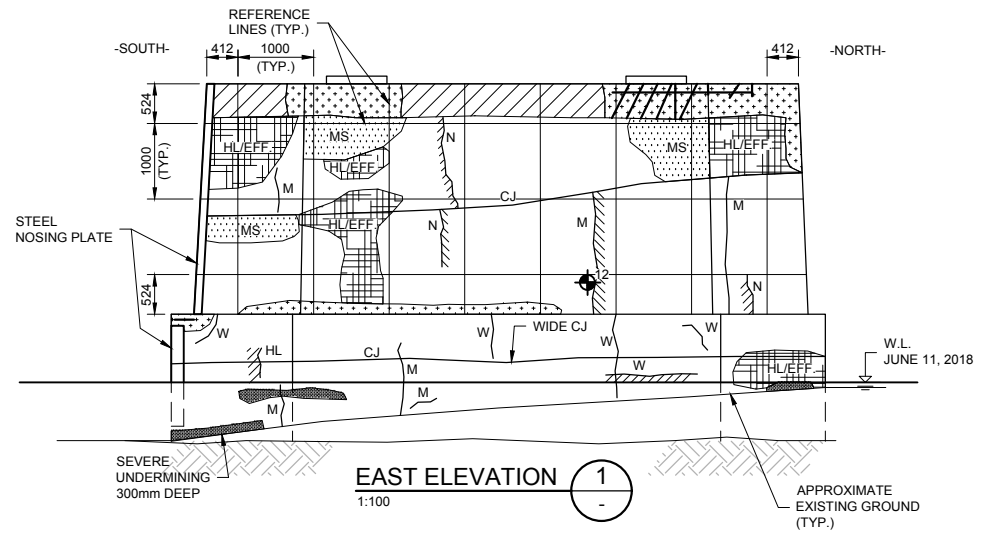

NOTE: LOCALIZED HL-N PATTERN CRACKING, LIGHT SCALING, AND EFFLORESCENCE STAINING LEACHING FROM BEARING SEAT TYP. THROUGHOUT FACES OF PIER

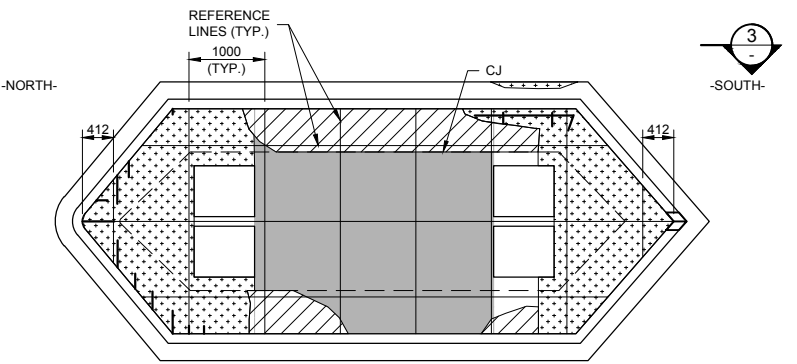

NOTE: LOCALIZED HL-N PATTERN CRACKING, LIGHT SCALING, AND EFFLORESCENCE STAINING LEACHING FROM BEARING SEAT TYP. THROUGHOUT FACES OF PIER

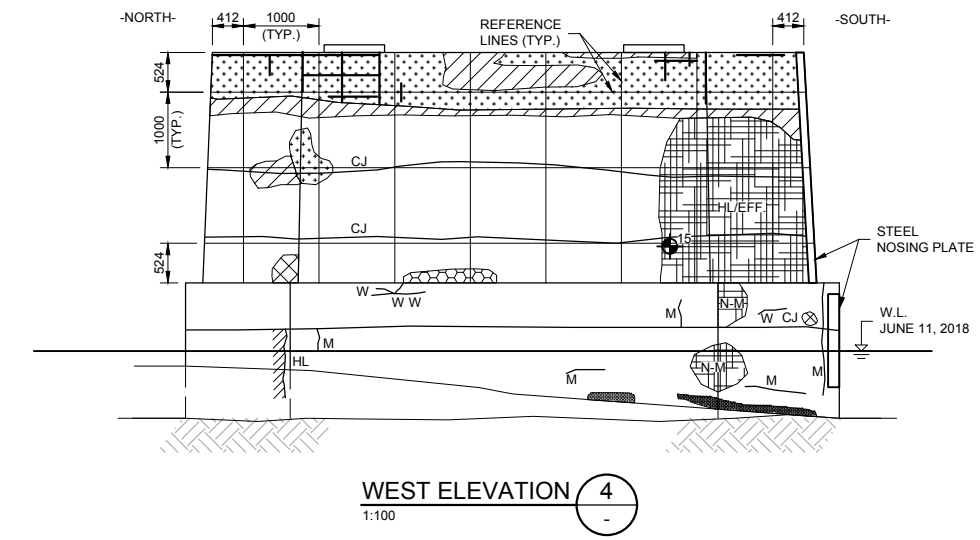
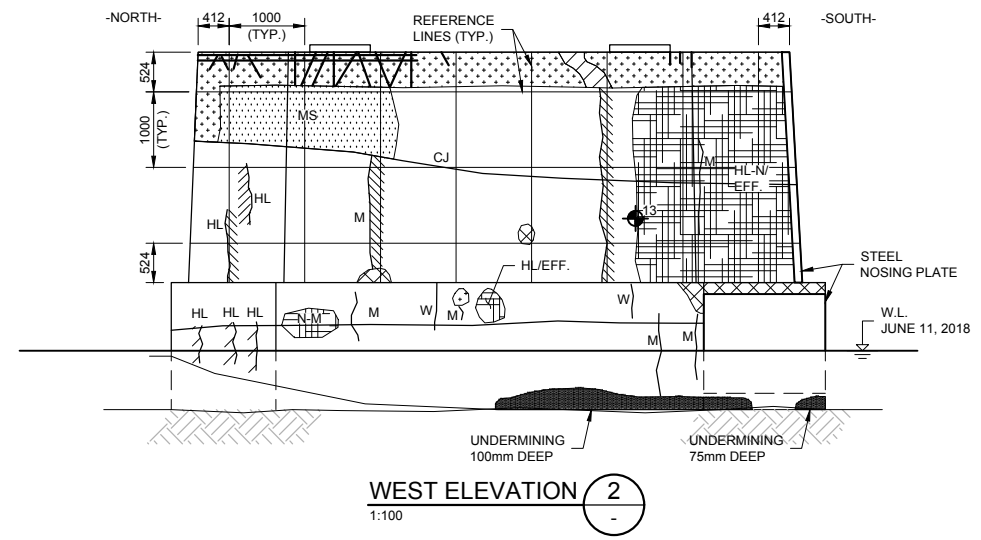

- LEGEND:**
- H — HAIRLINE CRACKS
 - N — NARROW CRACKS
 - M — MEDIUM CRACKS
 - W — WIDE CRACKS
 - STAINED CRACKS
 - EXPOSED REINFORCING STEEL
 - PATTERN CRACKING
 - DELAMINATIONS
 - SPALLS
 - MS — MEDIUM SCALING
 - SS — SEVERE SCALING
 - EROSION
 - DISINTEGRATION
 - HONEYCOMBED AREAS
 - ACCUMULATION OF DEBRIS
 - LIMITING INSPECTION

- LEGEND:**
- H — HAIRLINE CRACKS
 - N — NARROW CRACKS
 - M — MEDIUM CRACKS
 - W — WIDE CRACKS
 - /// STAINED CRACKS
 - EXPOSED REINFORCING STEEL
 - ▧ PATTERN CRACKING
 - ▨ DELAMINATIONS
 - ▩ SPALLS
 - MS MEDIUM SCALING
 - SS SEVERE SCALING
 - ER EROSION
 - DI DISINTEGRATION
 - HA HONEYCOMBED AREAS
 - AD ACCUMULATION OF DEBRIS
 - LI LIMITING INSPECTION

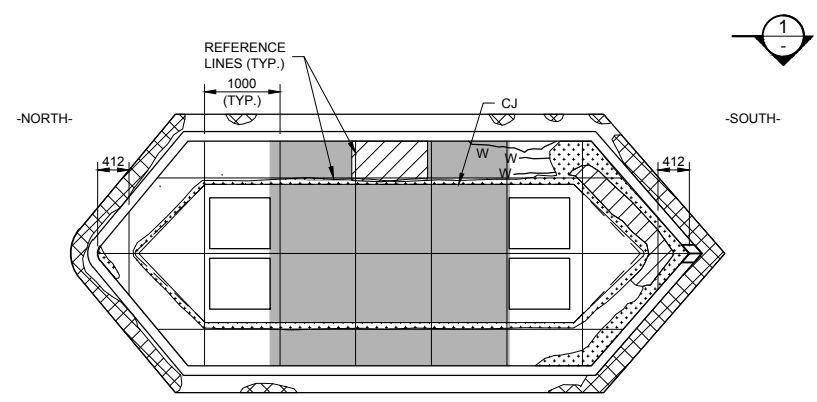
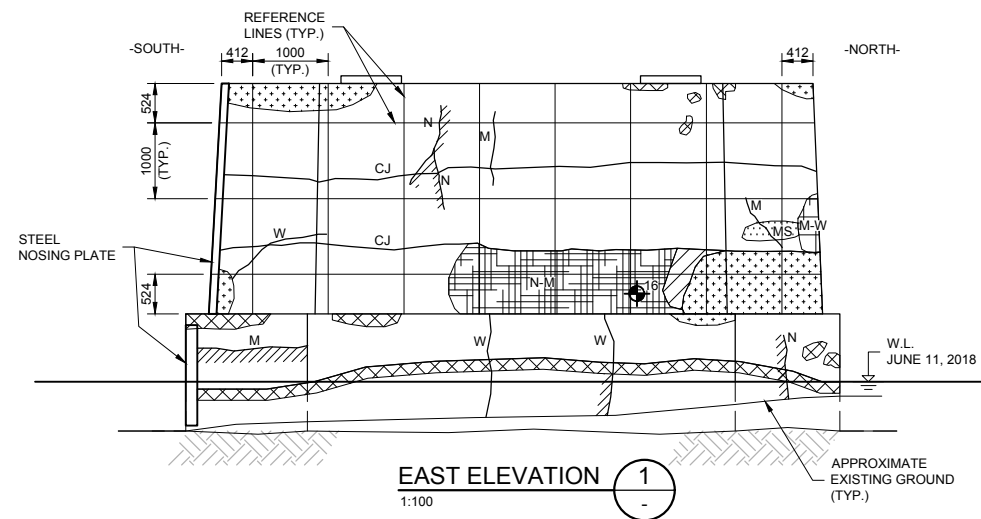

NOTE: LOCALIZED HL-N PATTERN CRACKING, LIGHT SCALING, AND EFFLORESCENCE STAINING LEACHING FROM BEARING SEAT TYP. THROUGHOUT FACES OF PIER

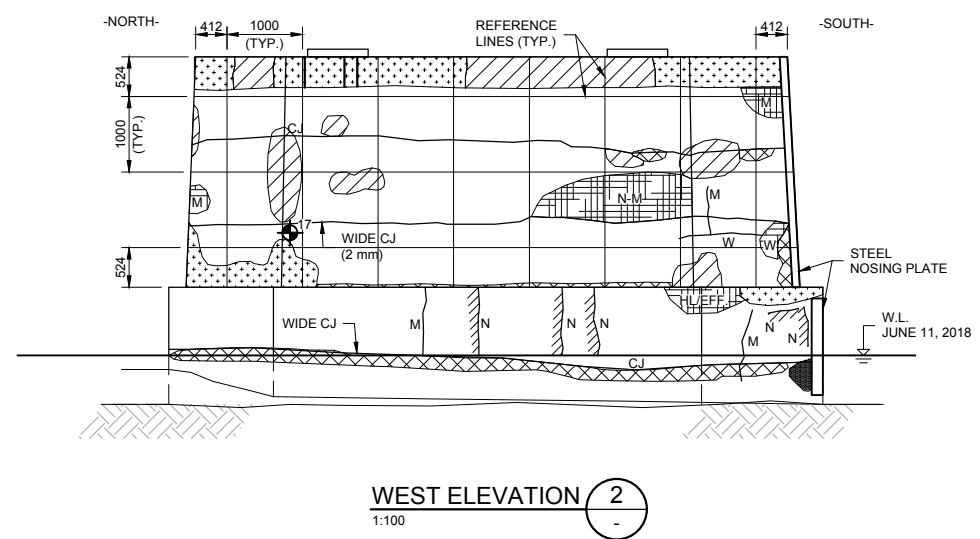

NOTE:



Contract #: ISD17-7087

**OLD RAILWAY RIDEAU
RIVER PEDESTRIAN BRIDGE
STRUCTURE No. 018600
DETAILED CONDITION ASSESSMENT**

PIER 7 DETERIORATION

APPENDIX E

Substructure Condition Survey Material Sampling and Testing Results (Gemtec)

August 28, 2018

File: 63333.36 – R2

Parsons Corporation
1223 Michael Street, Suite 100
Ottawa, Ontario
K1J 7T2

Attention: Patrick Mergel, M.Eng., P.Eng. – Senior Structural Engineer

**Re: Concrete Core Logging and Test Results
Old Railway Rideau River Bridge (SN 018600), Ottawa, Ontario**

As outlined in Houle Chevrier Engineering Ltd. (now GEMTEC Consulting Engineers and Scientists Limited) Proposal 63333.36 dated September 26, 2017, GEMTEC was retained by Parsons Corporation (Parsons) to carry out logging and materials testing of extracted concrete cores at the above noted site.

SCOPE OF SERVICES

Please find attached the following results of our scope of services:

- Digital photos of extracted core specimens (in PDF attached and JPEG format separately) in accordance with Part 1, Section 5 of the MTO Structure Rehabilitation Manual;
- Compressive strength test results from eighteen (18) prepared core specimens (detailed GEMTEC format);
- Chloride content test results from two (2) prepared core specimens (Certificate of Analysis from RPC Science and Engineering format);
- MTO Core Logs for Exposed Concrete for twenty (20) extracted core specimens in accordance with Part 1, Section 5 of the MTO Structure Rehabilitation Manual; and

A Summary of Findings of the above services is now provided.

SUMMARY OF FINDINGS

General

A total of 20 cores were extracted, with the general locations noted in Table 1. In general, the piers, abutments and wingwalls are primarily comprised of Portland Cement Concrete (PCC), although it appears that different mixes have been applied over time through rehabilitative efforts. A central mass of stone was observed in Piers 1, 2, 4, 6 and 7 as well as the West Abutment.

Table 1. Summary of Coring Effort and Test Results

Location	Core No.	Compressive Strength, MPa (approx. Depth)	Chloride Content, Corrected Percent (Depth)
East Abutment	1	24.8 (200 to 400mm)	n/a
	2	13.6 (0 to 140mm)	n/a
E. Abutment WW	3	n/a	0.111 @ 0-10mm 0.045 @ 80-90mm
Pier 1 East	4	n/a	n/a
Pier 1 West	5	39.1 (0 to 400mm)	n/a
		91.4 (400 to 635mm)	
Pier 2 East	6	21.8 (300 to 610mm)	n/a
Pier 2 West	7	23.3 (0 to 130mm)	n/a
Pier 3 East	8	41.9 (0 to 138mm)	n/a
Pier 3 West	9	34.8 (330 to 622mm)	n/a
Pier 4 East	10	18.9 (280 to 483mm)	n/a
Pier 4 West	11	14.0 (0 to 115mm)	n/a
Pier 5 East	12	38.8 (0 to 162mm)	n/a
Pier 5 West	13	38.0 (200 to 390mm)	n/a
Pier 6 East	14	48.0 (0 to 194mm)	n/a
Pier 6 West	15	41.3 (130 to 320mm)	n/a
Pier 7 East	16	15.2 (150 to 345mm)	n/a
Pier 7 West	17	26.9 (0 to 195mm)	n/a
West Abutment	18	29.0 (180 to 380mm)	n/a
	19	53.2 (0 to 190mm)	n/a
W. Abutment WW	20	n/a	0.153 @ 0-10mm 0.000 @ 60-70mm

Compressive Strength Results

Compressive strength results are also summarized in Table 1. As the core specimens comprised different types of materials from previous construction/rehabilitation efforts, compressive strength specimens were selected in an effort to provide the representative strength of each constituent material.

Overall, compressive strength test results ranged from a low of 13.6 MPa to a high of 91.4 MPa, although the greatest value was achieved from a portion of a core that visually resembles stone as opposed to concrete. Removing this result as an outlier, the compressive strength results ranged from 13.6 to 53.2 MPa with an arithmetic average of 30.7 MPa.

As shown, relatively low compressive strength results were observed for the East Abutment (13.6 to 24.8 MPa), Pier 2 (21.8 to 23.3 MPa), Pier 4 (14.0 to 18.9 MPa), and Pier 7 East (15.2 MPa).

Chloride Content Results

At the direction of Parsons, chloride content testing was completed on Cores 3 and 20 representing the East and West Abutment Wingwalls, respectively. The results are also summarized in Table 1 (high and low values only – see attached core logs for detailed results).

As per Section 5.4.3 of the MTO Structural Rehabilitation Manual (SRM), the background chloride content was selected as the lowest value for all cores tested from that component. Visual inspection of the core log for Core 3 suggests that chlorides have penetrated the cover concrete and started to corrode the reinforcing steel. The use of the lowest chloride value from Core 3 as the background value is therefore not appropriate. As such, the lowest chloride value from Core 20 (0.027 percent) has been used as the background value for both Cores 3 and 20.

Corrected chloride content results ranged between 0.111 and 0.045 percent for Core 3 (East Abutment Wingwall) and between 0.153 to 0.000 percent for Core 20 (West Abutment Wingwall).

Using the chloride content provided in the MTO SRM of 0.025 percent as a conservative lower bound for corrosion potential:

- Significant corrosion of reinforcing steel is likely in the East Abutment Wingwall since elevated chloride content results were observed immediately above the rebar. The log for Core 3 supports this result.
- Significant corrosion of reinforcing steel is unlikely in the West Abutment Wingwall if located deeper than 30 millimetres from the exposed surface. The log for Core 20 supports this result.

Visual Condition of Concrete

Surface Condition and Weathering

The surface condition of most cores displayed minor scaling. Weathering (i.e. visual deterioration of the PCC) and a pinkish hue was observed to various depths in many core locations.

Delamination and Breaks

Delamination and/or breaks were observed at the interface between differing materials or at rebar locations in Cores 1, 2, 3, 5, 10, 11, 14, 15, 17, and 18.

Breaks within (apparently) the same PCC material were observed in Core 8 (Pier 3 East) at a depth of 175 millimetres from surface, Core 9 (Pier 3 West) at a depth of 330 millimetres from surface, and Core 16 (Pier 7 East) at a depth of 95 millimetres from surface.

Cracking

Cracking transversely across the core was observed in Cores 2 (East Abutment), 3 (East Abutment Wingwall) and 4 (Pier 1 East). Vertical cracking along the core was observed in Cores 4 (Pier 1 East) and 18 (West Abutment).

Core 4 (Pier 1 East) displayed transverse and vertical cracking along its entire length.

Condition of Rebar

Rebar was observed in Cores 3 and 11 through 20. The approximate diameter of the rebar was 21 to 22 millimetres, suggesting a #22 metric or #7 Imperial bar size.

Severe Rust (SR) was observed on the rebar at Core 3 (East Abutment Wingwall) and Core 15 (Pier 6 West), while Light Rust (LR) was observed on the rebar at Cores 8 (Pier 3 East), 11 (Pier 4 West), and 12 through 20.

It is noteworthy that some of the LR may have resulted from the wet coring operation as opposed to chlorides within the PCC, particularly for Core 8.

Other

Mesh was observed in Core 17 (Pier 7 West) at the interface between stone and PCC at a depth of 508 millimetres from surface.

CLOSURE

We trust that this information is sufficient for your purposes. If you have any questions or require additional information, please contact the undersigned.



Stephen Goodman, Ph.D., P.Eng.
Manager, Pavements and Materials

P:\0. Files\63300\63333.36\Final Report\63333.36_LTR01_V03_2018-08-28.docx



ATTACHMENTS

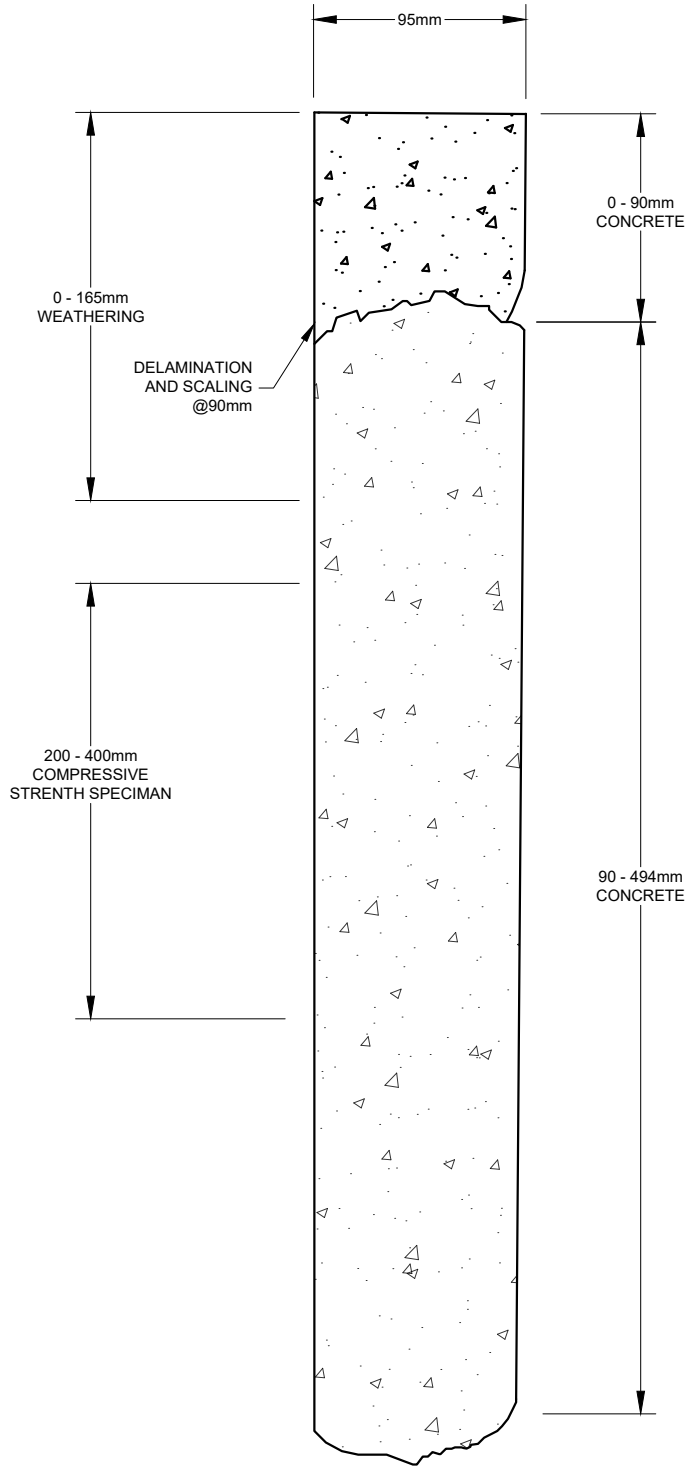

32 Steacie Drive, Ottawa, ON K2K 2A9
 T: (613) 836-1422 | www.gemtec.ca | ottawa@gemtec.ca

CORE 1

Project CONCRETE CORE LOGGING & TEST RESULTS
 OLD RAILWAY RIDEAU RIVER BRIDGE (SN 018600)
 OTTAWA, ONTARIO

Project No.
 63333.36

FIGURE 1

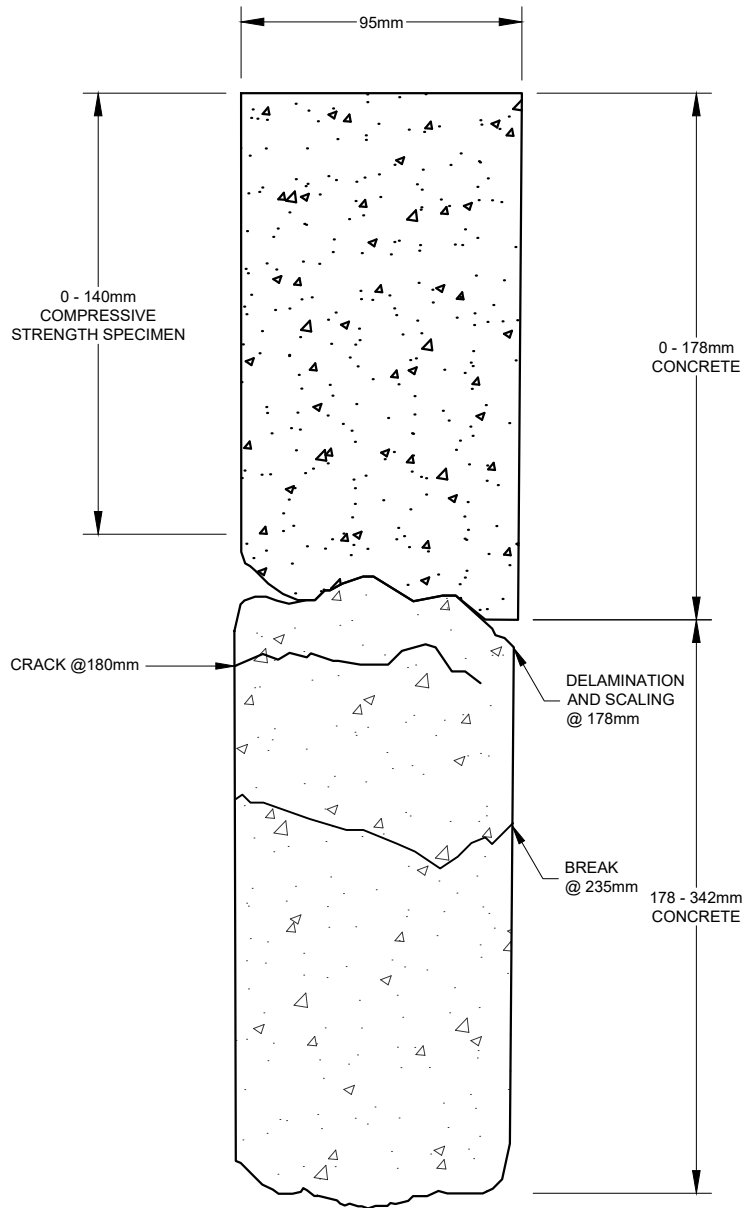

32 Steacie Drive, Ottawa, ON K2K 2A9
T: (613) 836-1422 | www.gemtec.ca | ottawa@gemtec.ca

CORE 2

Project CONCRETE CORE LOGGING & TEST RESULTS
OLD RAILWAY RIDEAU RIVER BRIDGE (SN 018600)
OTTAWA, ONTARIO

Project No.
63333.36

FIGURE 2

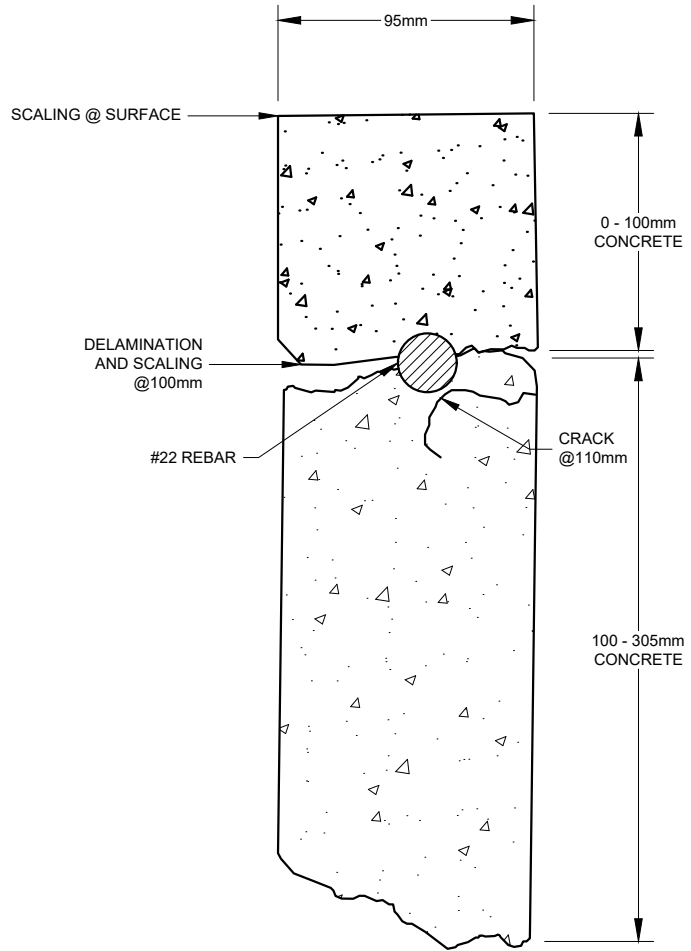

CORE 3



32 Steacie Drive, Ottawa, ON K2K 2A9
 T: (613) 836-1422 | www.gemtec.ca | ottawa@gemtec.ca

Project CONCRETE CORE LOGGING & TEST RESULTS
 OLD RAILWAY RIDEAU RIVER BRIDGE (SN 018600)
 OTTAWA, ONTARIO

Project No.
 63333.36

FIGURE 3

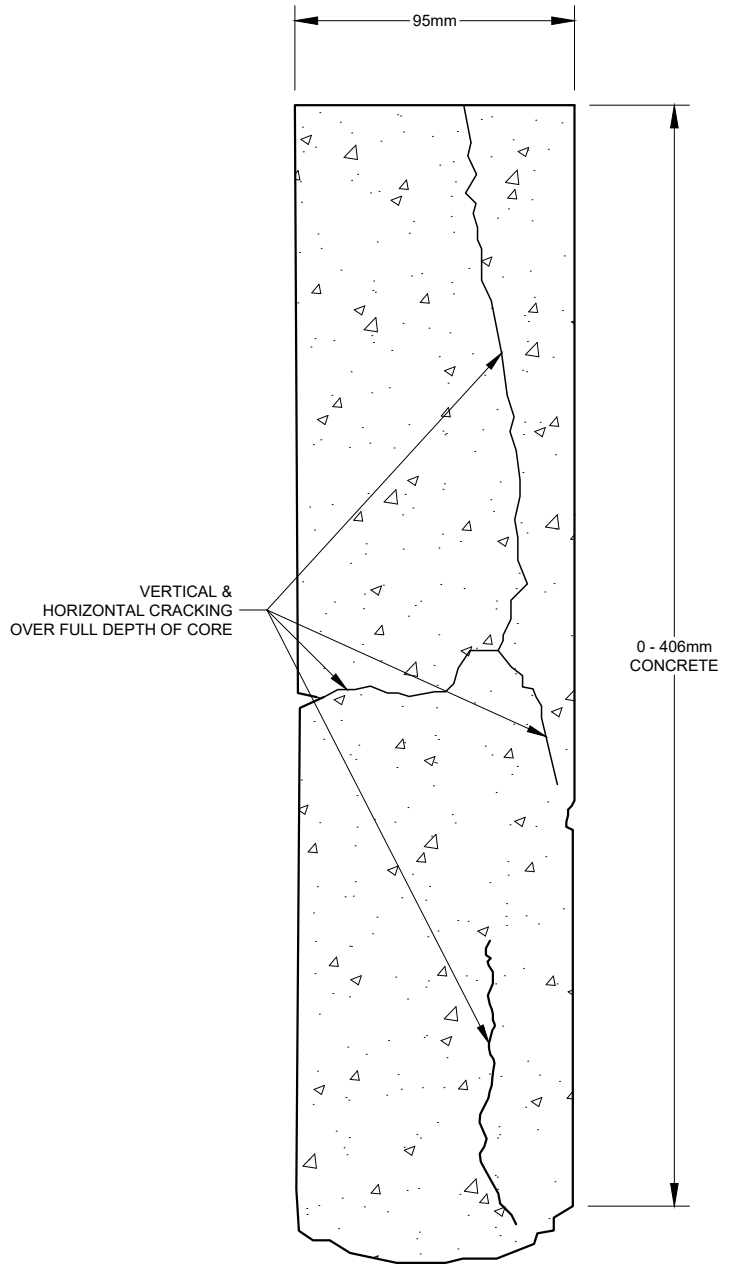
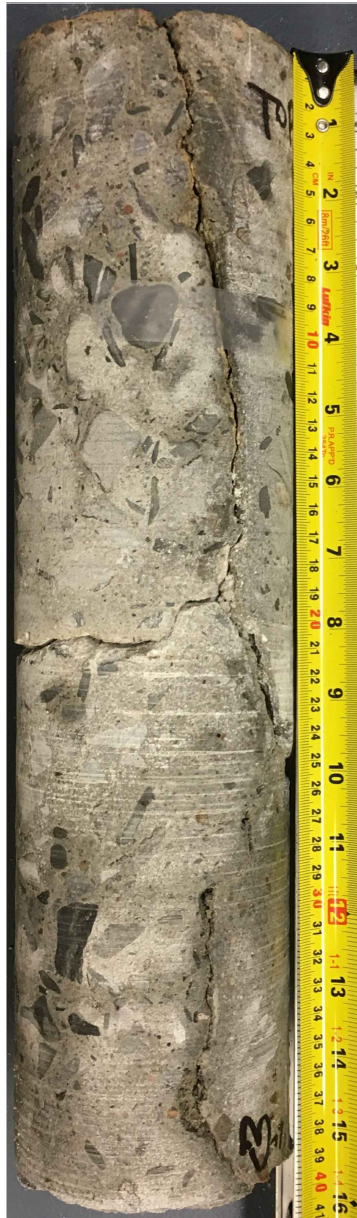

GEMTEC
CONSULTING ENGINEERS
AND SCIENTISTS

32 Steacie Drive, Ottawa, ON K2K 2A9
T: (613) 836-1422 | www.gemtec.ca | ottawa@gemtec.ca

CORE 4		
Project	CONCRETE CORE LOGGING & TEST RESULTS OLD RAILWAY RIDEAU RIVER BRIDGE (SN 018600) OTTAWA, ONTARIO	Project No. 63333.36
		FIGURE 4

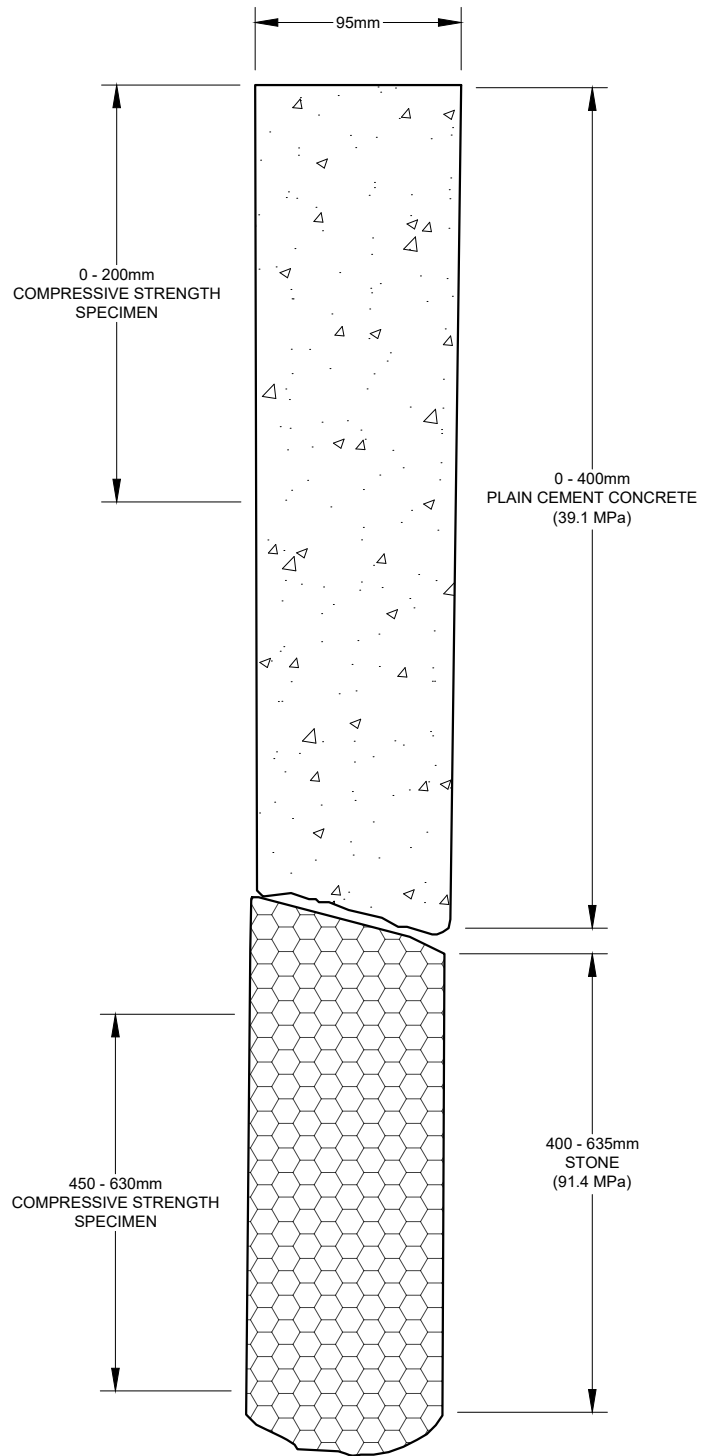

CORE 5



32 Steacie Drive, Ottawa, ON K2K 2A9
T: (613) 836-1422 | www.gemtec.ca | ottawa@gemtec.ca

Project CONCRETE CORE LOGGING & TEST RESULTS
OLD RAILWAY RIDEAU RIVER BRIDGE (SN 018600)
OTTAWA, ONTARIO

Project No.
63333.36

FIGURE 5

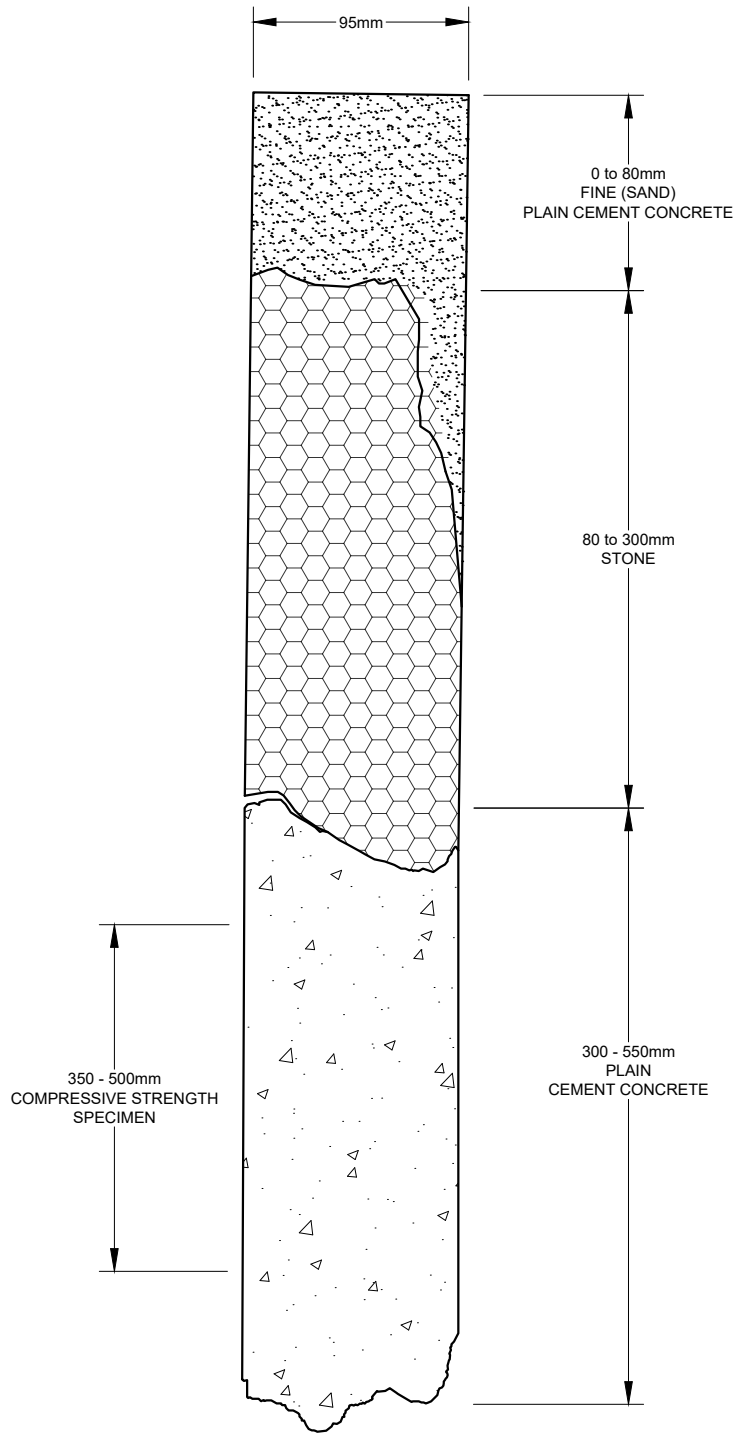

32 Steacie Drive, Ottawa, ON K2K 2A9
 T: (613) 836-1422 | www.gemtec.ca | ottawa@gemtec.ca

CORE 6

Project CONCRETE CORE LOGGING & TEST RESULTS
 OLD RAILWAY RIDEAU RIVER BRIDGE (SN 018600)
 OTTAWA, ONTARIO

Project No.
 63333.36

FIGURE 6

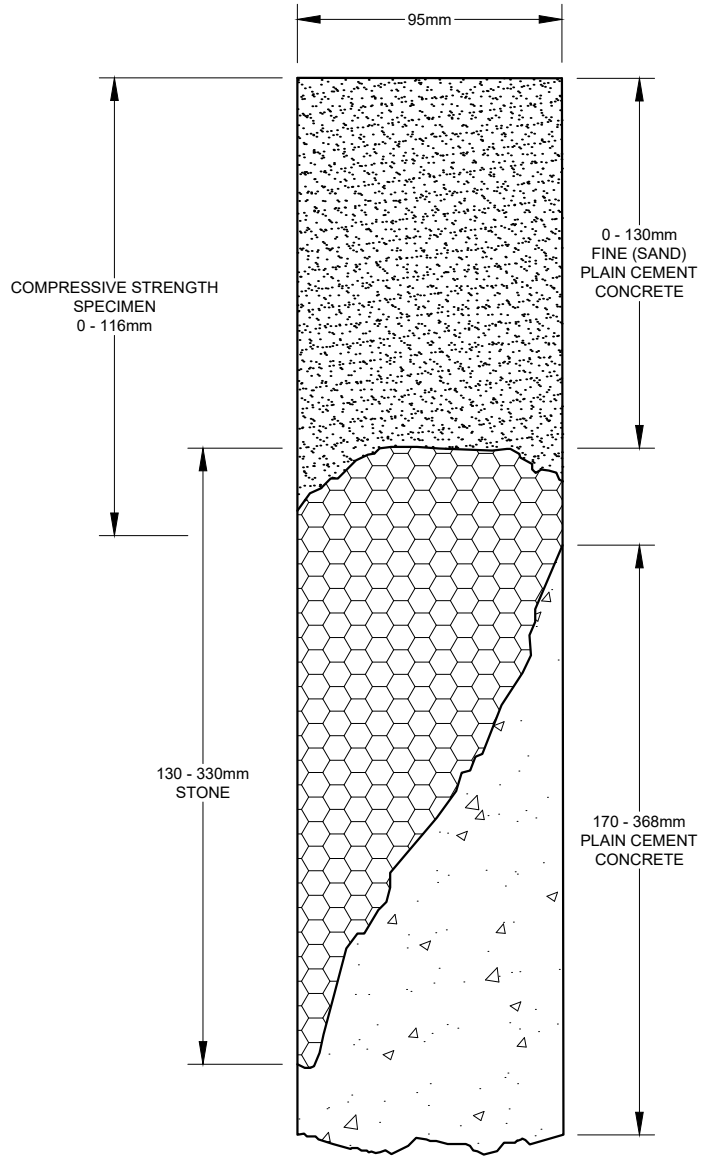

32 Steacie Drive, Ottawa, ON K2K 2A9
T: (613) 836-1422 | www.gemtec.ca | ottawa@gemtec.ca

CORE 7

Project CONCRETE CORE LOGGING & TEST RESULTS
OLD RAILWAY RIDEAU RIVER BRIDGE (SN 018600)
OTTAWA, ONTARIO

Project No.
63333.36

FIGURE 7

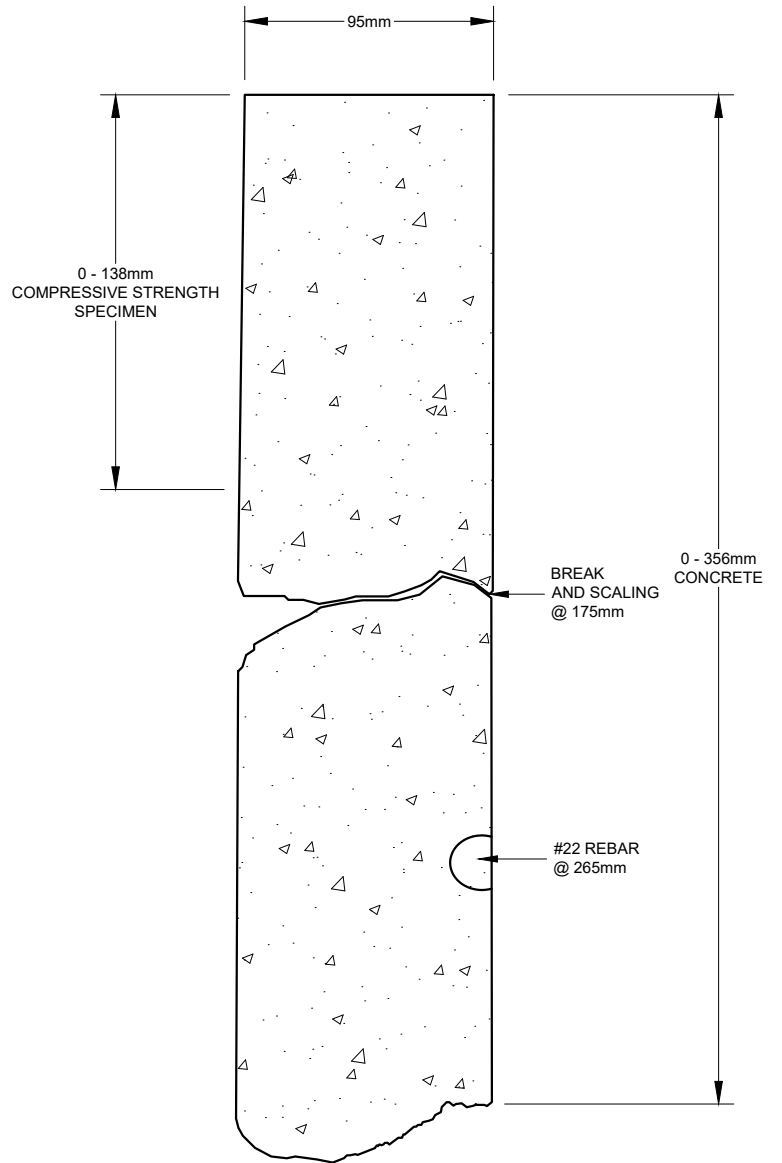

32 Steacie Drive, Ottawa, ON K2K 2A9
T: (613) 836-1422 | www.gemtec.ca | ottawa@gemtec.ca

CORE 8

Project CONCRETE CORE LOGGING & TEST RESULTS
OLD RAILWAY RIDEAU RIVER BRIDGE (SN 018600)
OTTAWA, ONTARIO

Project No.
63333.36

FIGURE 8

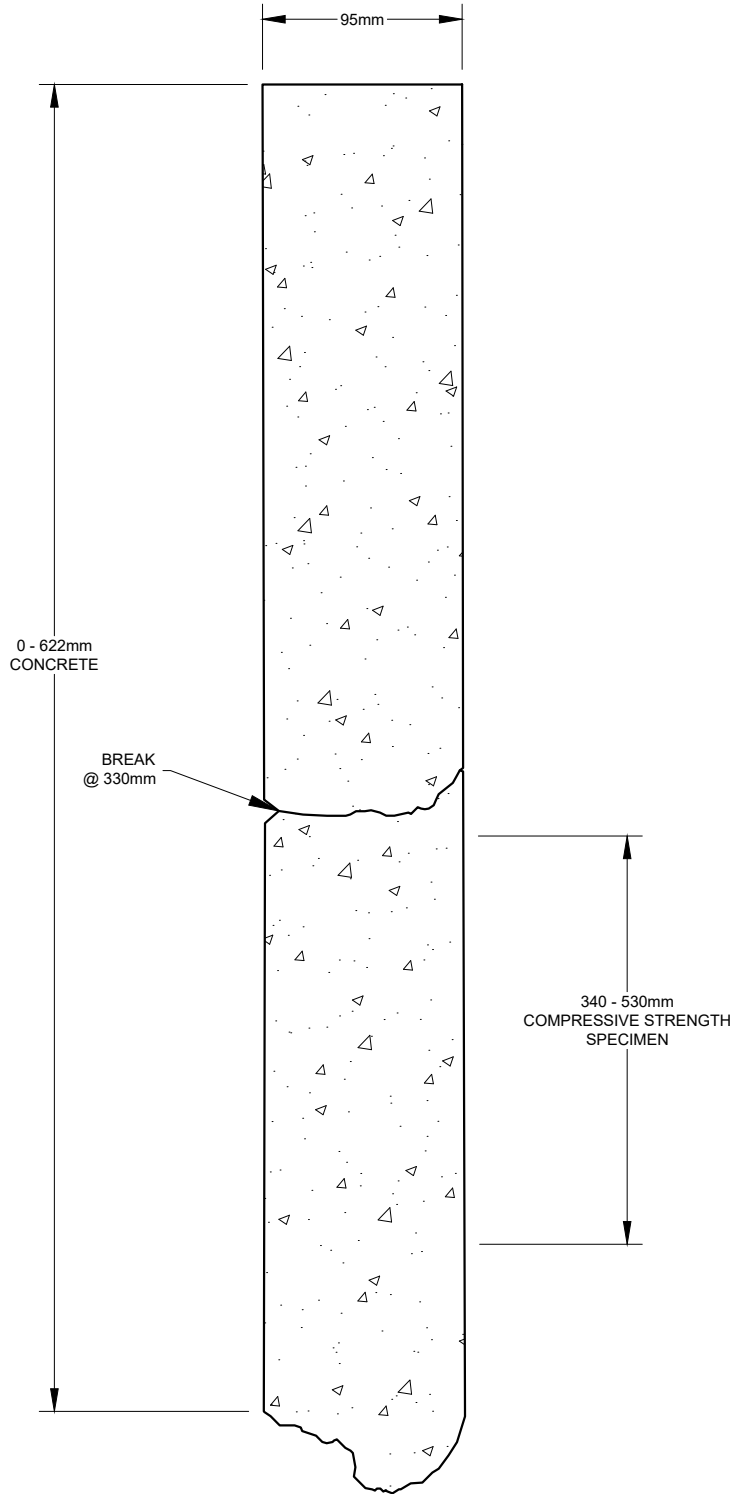

32 Steacie Drive, Ottawa, ON K2K 2A9
T: (613) 836-1422 | www.gemtec.ca | ottawa@gemtec.ca

CORE 9

Project CONCRETE CORE LOGGING & TEST RESULTS
OLD RAILWAY RIDEAU RIVER BRIDGE (SN 018600)
OTTAWA, ONTARIO

Project No.
63333.36

FIGURE 9

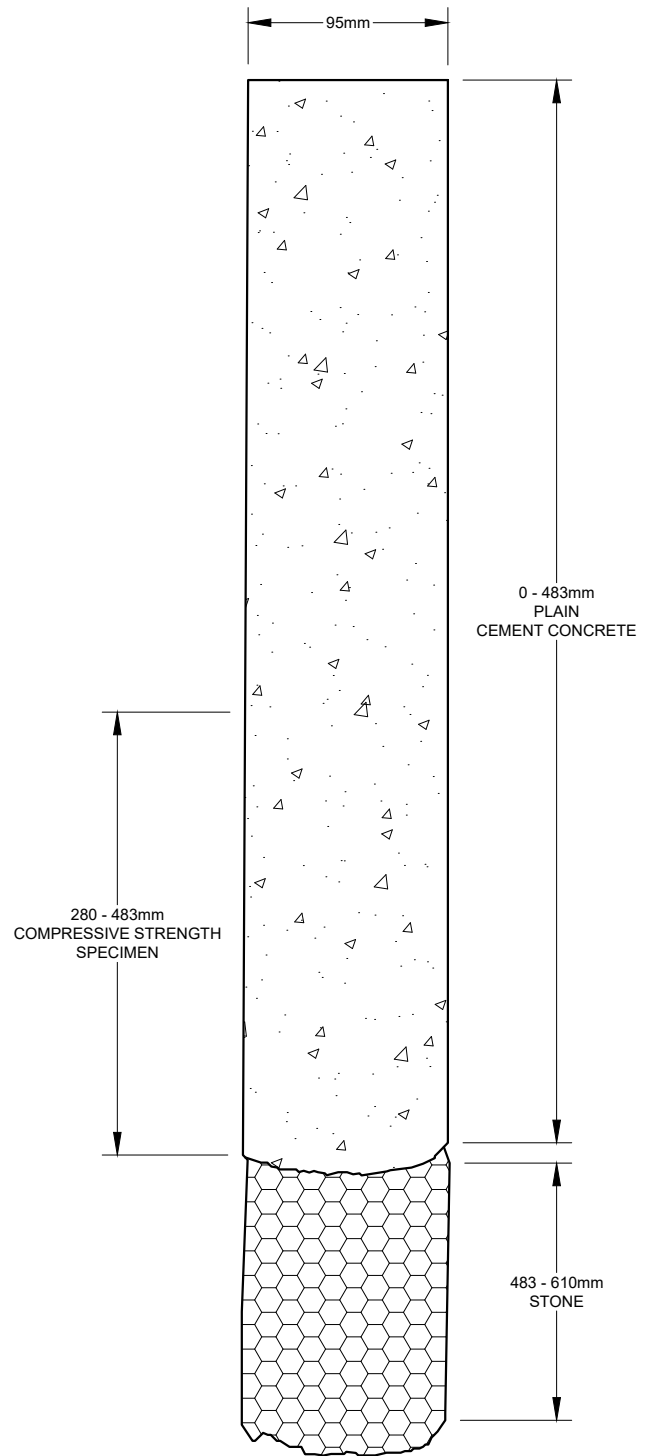

32 Steacie Drive, Ottawa, ON K2K 2A9
T: (613) 836-1422 | www.gemtec.ca | ottawa@gemtec.ca

CORE 10

Project CONCRETE CORE LOGGING & TEST RESULTS
OLD RAILWAY RIDEAU RIVER BRIDGE (SN 018600)
OTTAWA, ONTARIO

Project No.
63333.36

FIGURE 10

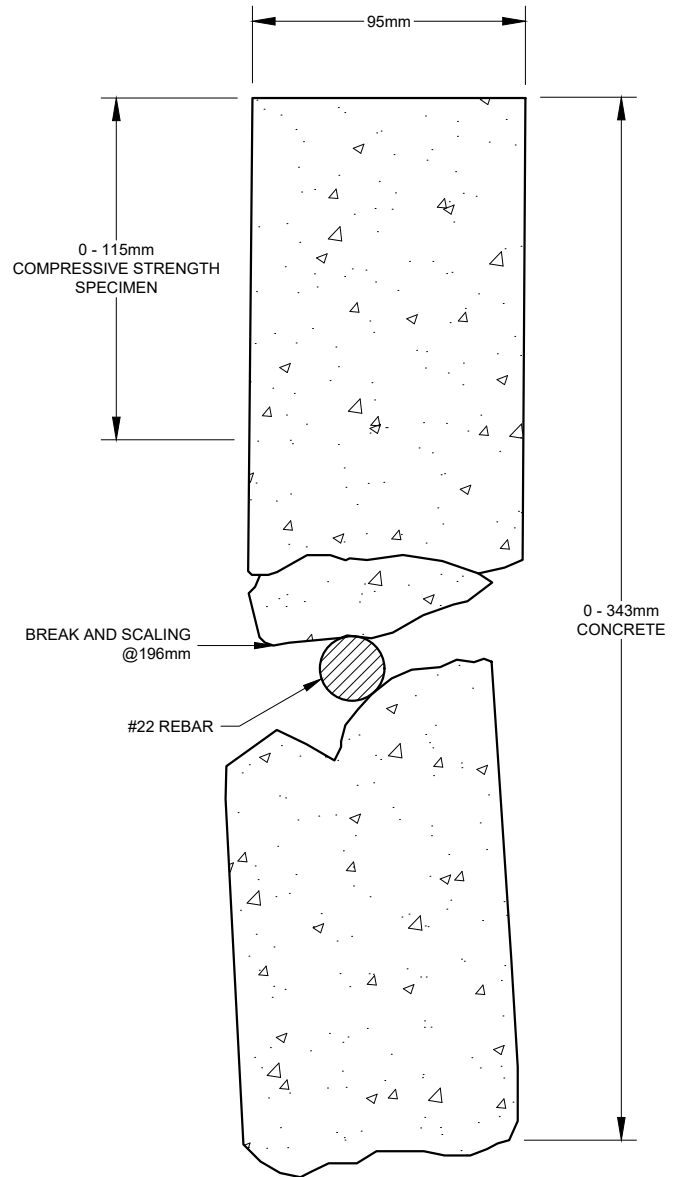

32 Steacie Drive, Ottawa, ON K2K 2A9
T: (613) 836-1422 | www.gemtec.ca | ottawa@gemtec.ca

CORE 11

Project CONCRETE CORE LOGGING & TEST RESULTS
OLD RAILWAY RIDEAU RIVER BRIDGE (SN 018600)
OTTAWA, ONTARIO

Project No.
63333.36

FIGURE 11

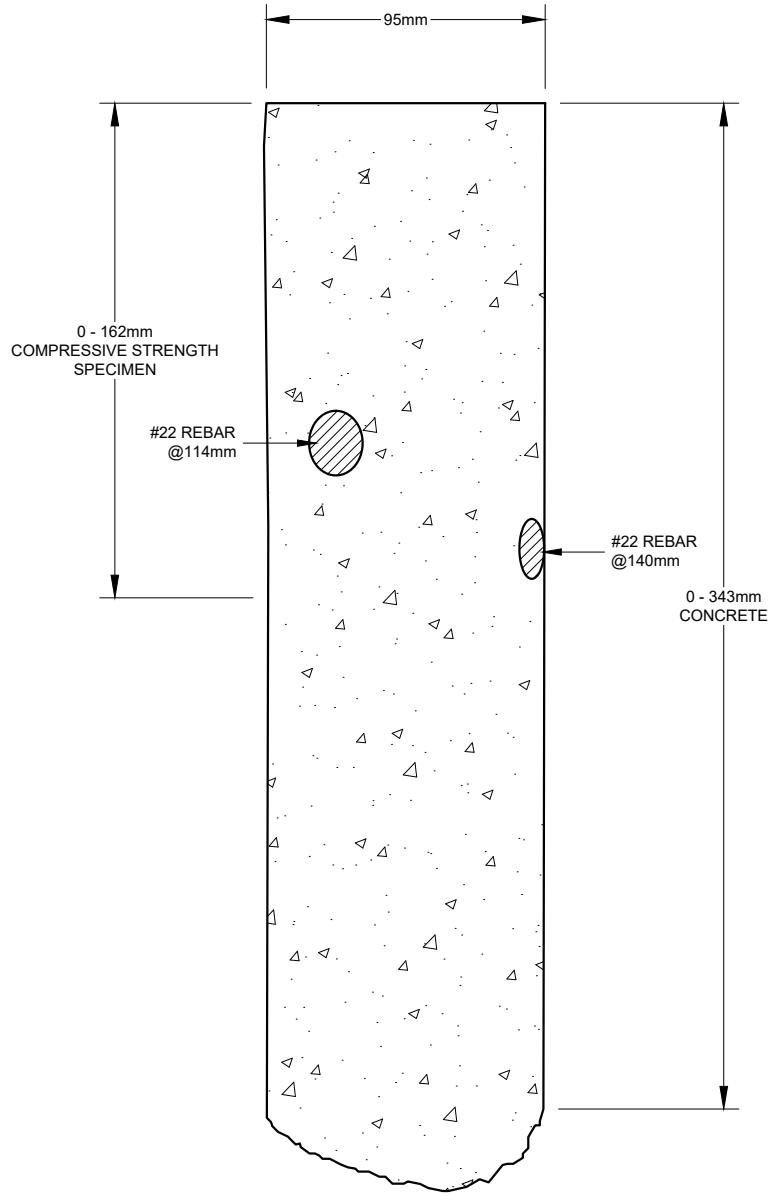

32 Steacie Drive, Ottawa, ON K2K 2A9
 T: (613) 836-1422 | www.gemtec.ca | ottawa@gemtec.ca

CORE 12

Project CONCRETE CORE LOGGING & TEST RESULTS
 OLD RAILWAY RIDEAU RIVER BRIDGE (SN 018600)
 OTTAWA, ONTARIO

Project No.
 63333.36

FIGURE 12

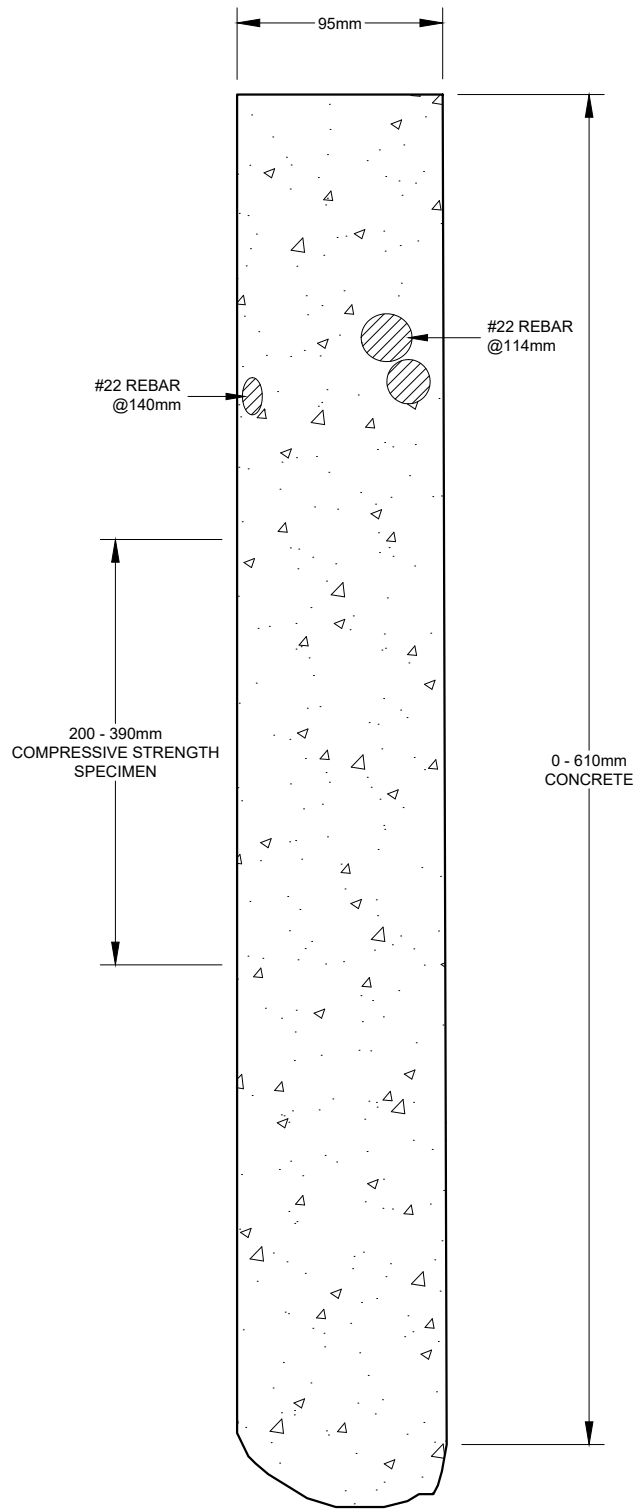

32 Steacie Drive, Ottawa, ON K2K 2A9
 T: (613) 836-1422 | www.gemtec.ca | ottawa@gemtec.ca

CORE 13

Project CONCRETE CORE LOGGING & TEST RESULTS
 OLD RAILWAY RIDEAU RIVER BRIDGE (SN 018600)
 OTTAWA, ONTARIO

Project No.
 63333.36

FIGURE 13

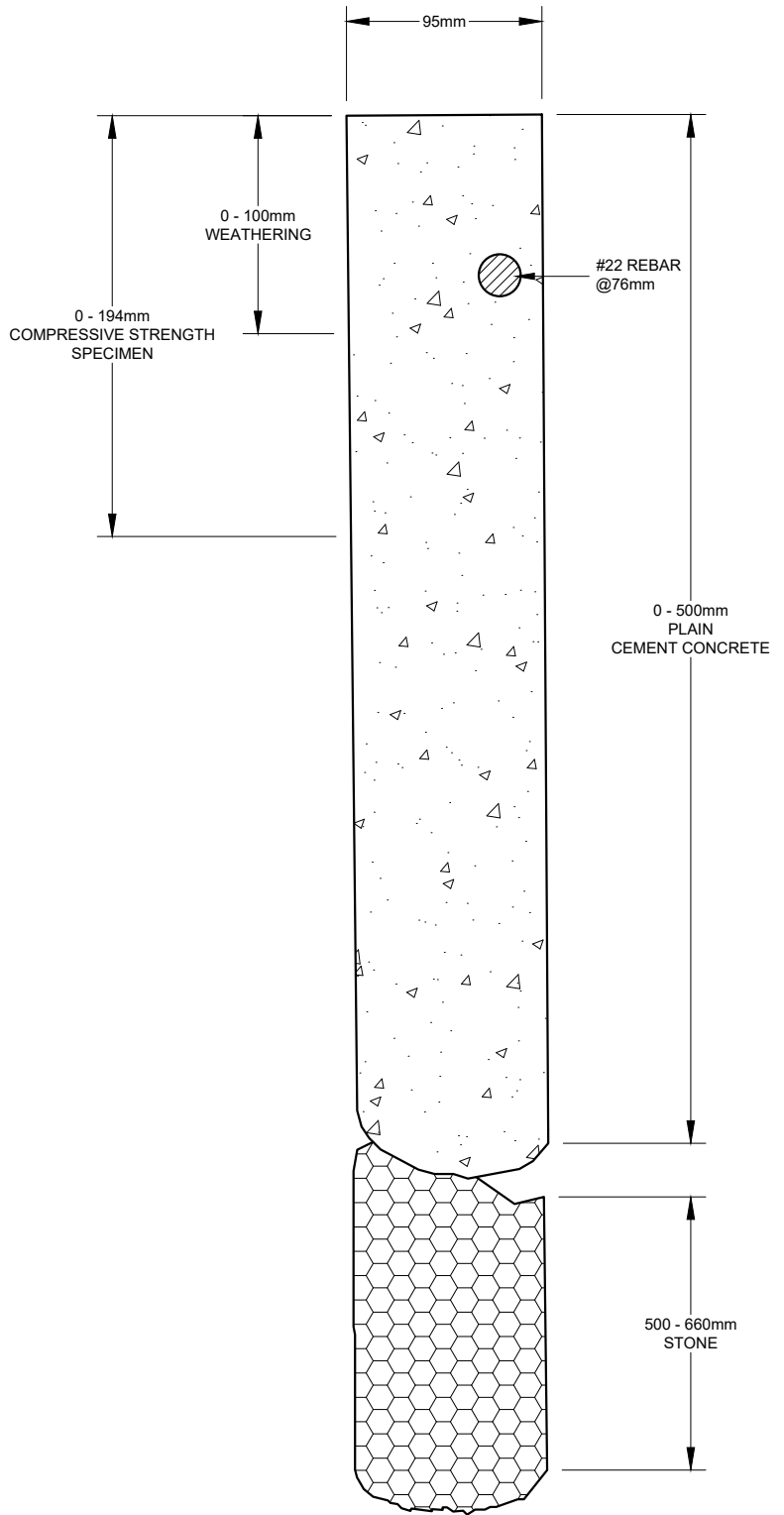

GEMTEC

CONSULTING ENGINEERS
AND SCIENTISTS

32 Steacie Drive, Ottawa, ON K2K 2A9
T: (613) 836-1422 | www.gemtec.ca | ottawa@gemtec.ca

CORE 14

Project CONCRETE CORE LOGGING & TEST RESULTS
OLD RAILWAY RIDEAU RIVER BRIDGE (SN 018600)
OTTAWA, ONTARIO

Project No.
63333.36

FIGURE 14

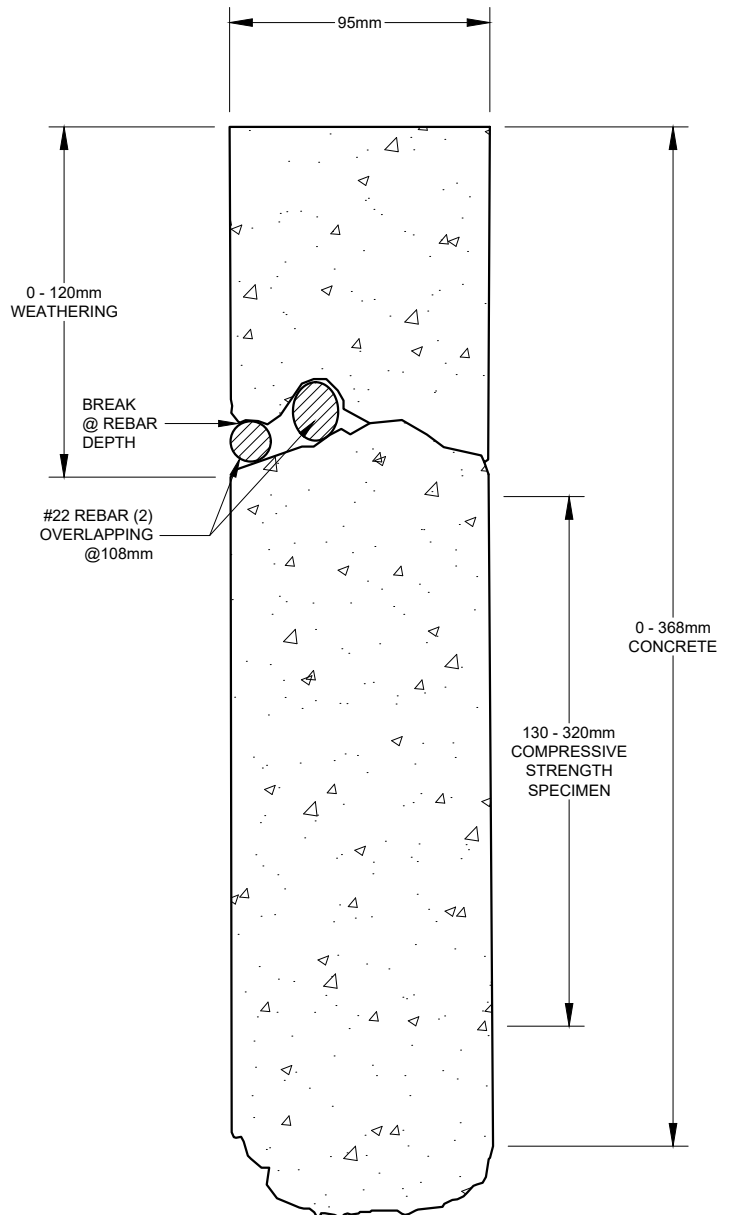

32 Steacie Drive, Ottawa, ON K2K 2A9
 T: (613) 836-1422 | www.gemtec.ca | ottawa@gemtec.ca

CORE 15

Project CONCRETE CORE LOGGING & TEST RESULTS
 OLD RAILWAY RIDEAU RIVER BRIDGE (SN 018600)
 OTTAWA, ONTARIO

Project No.
 63333.36

FIGURE 15

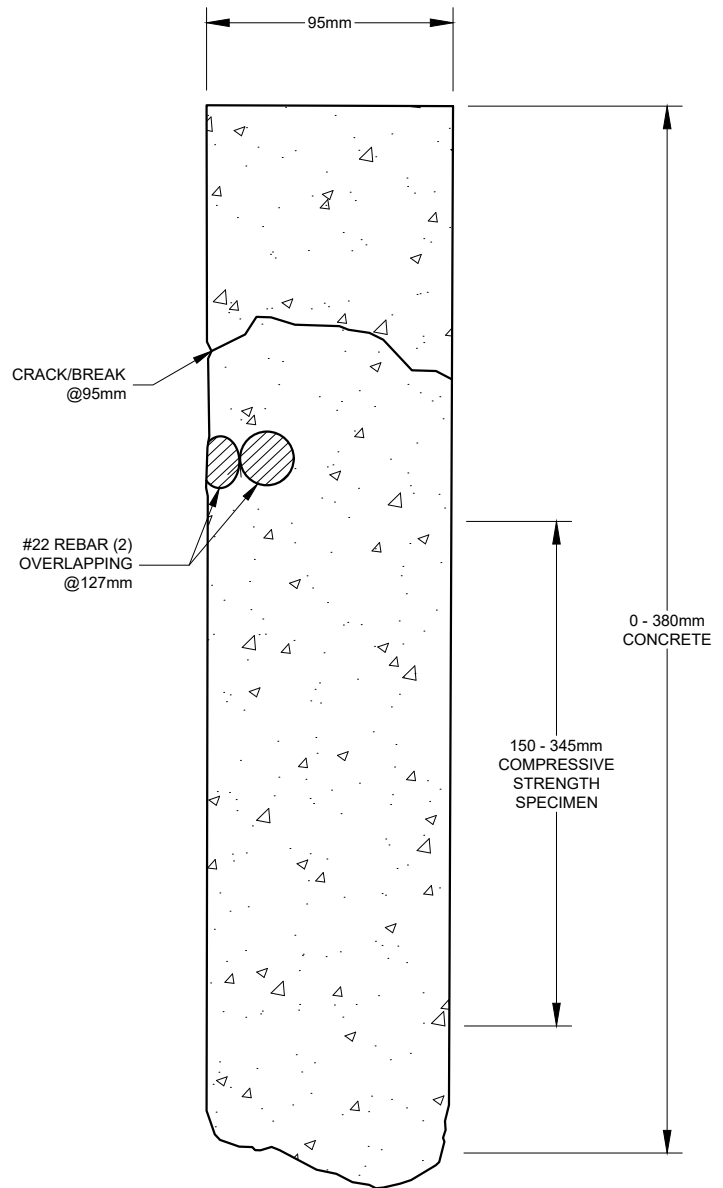

32 Steacie Drive, Ottawa, ON K2K 2A9
 T: (613) 836-1422 | www.gemtec.ca | ottawa@gemtec.ca

CORE 16

Project CONCRETE CORE LOGGING & TEST RESULTS
 OLD RAILWAY RIDEAU RIVER BRIDGE (SN 018600)
 OTTAWA, ONTARIO

Project No.
 63333.36

FIGURE 16

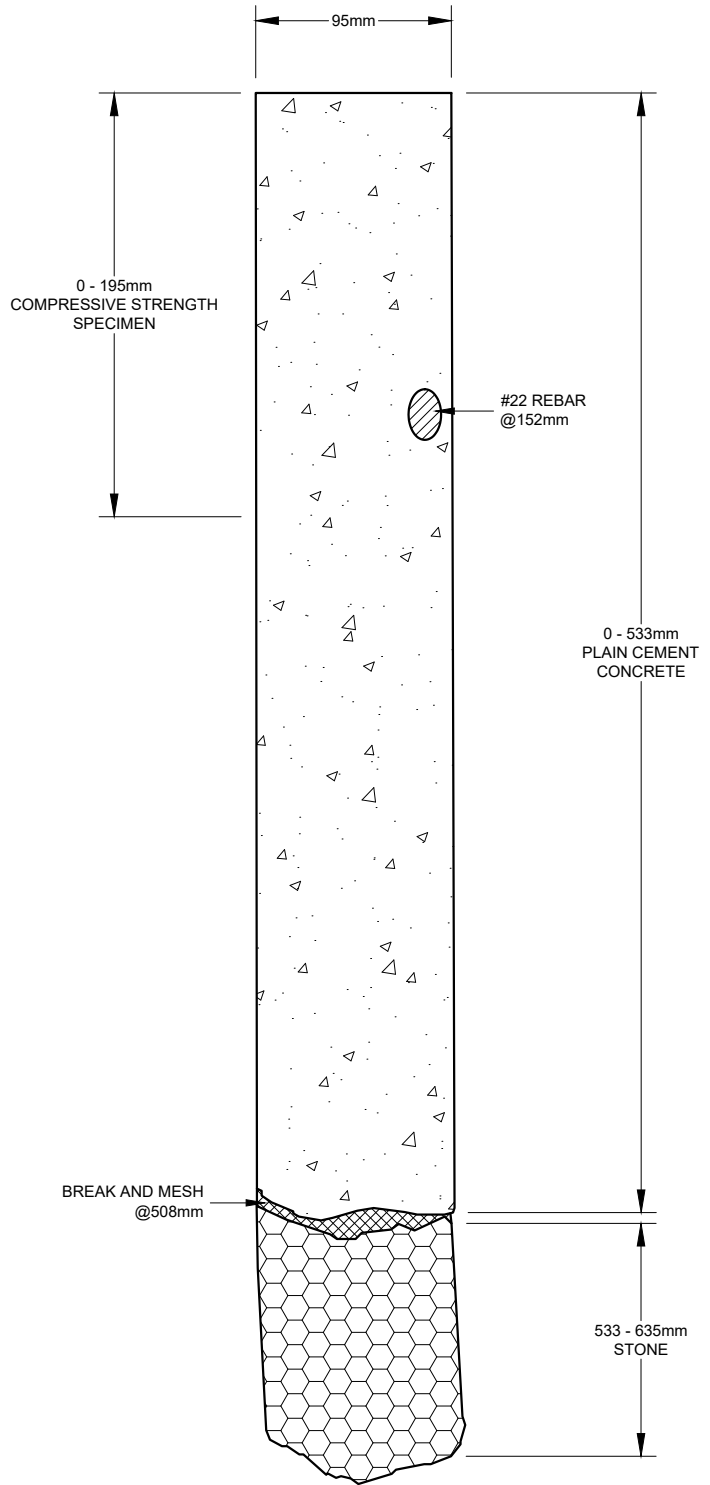

32 Steacie Drive, Ottawa, ON K2K 2A9
 T: (613) 836-1422 | www.gemtec.ca | ottawa@gemtec.ca

CORE 17

Project CONCRETE CORE LOGGING & TEST RESULTS
 OLD RAILWAY RIDEAU RIVER BRIDGE (SN 018600)
 OTTAWA, ONTARIO

Project No.
 63333.36

FIGURE 17

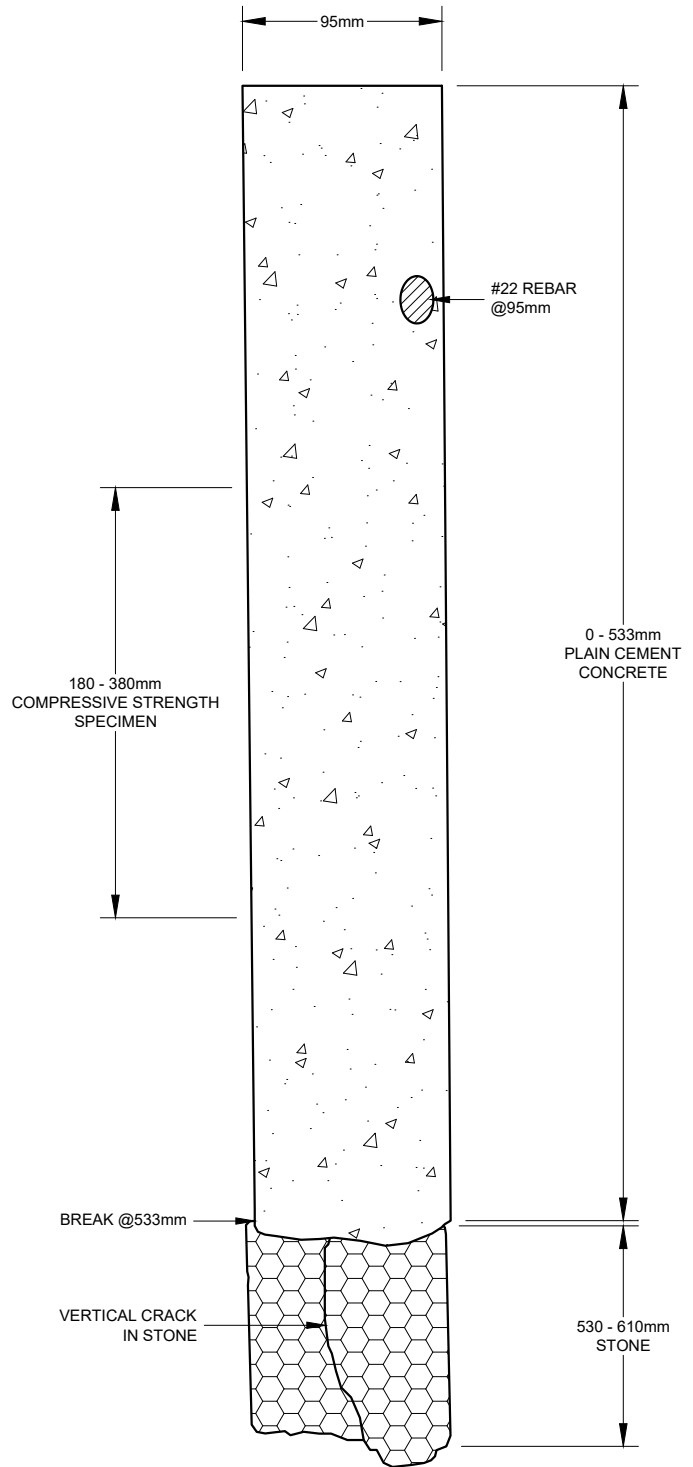

32 Steacie Drive, Ottawa, ON K2K 2A9
 T: (613) 836-1422 | www.gemtec.ca | ottawa@gemtec.ca

CORE 18

Project CONCRETE CORE LOGGING & TEST RESULTS
 OLD RAILWAY RIDEAU RIVER BRIDGE (SN 018600)
 OTTAWA, ONTARIO

Project No.
 63333.36

FIGURE 18

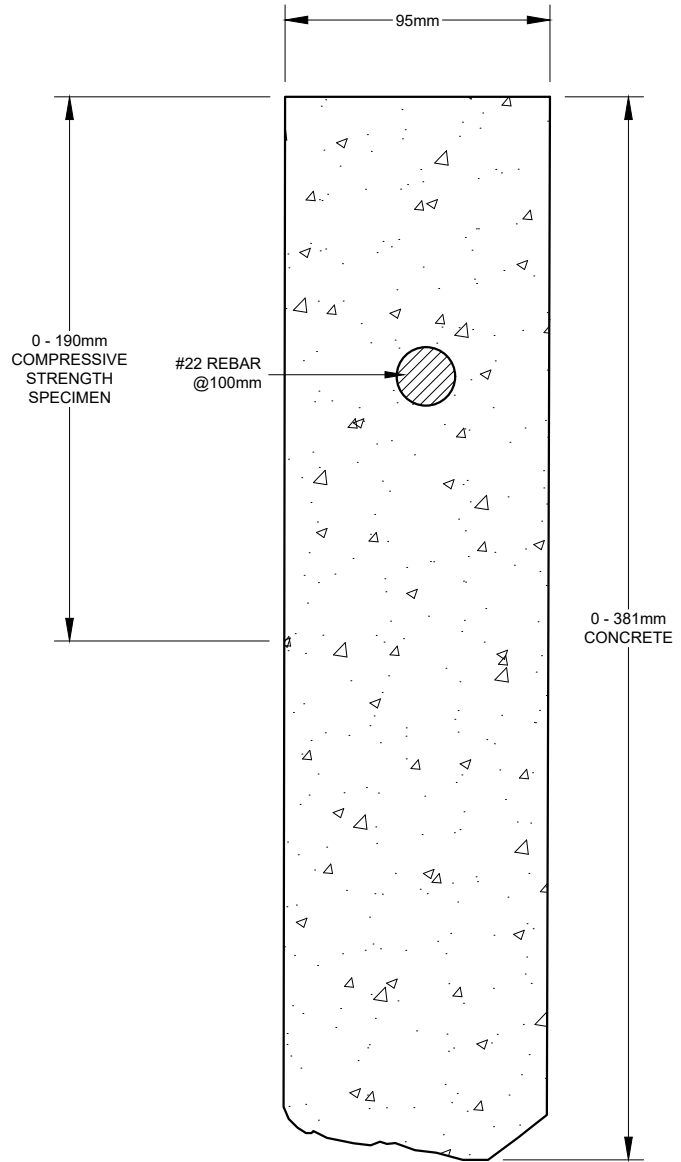

32 Steacie Drive, Ottawa, ON K2K 2A9
 T: (613) 836-1422 | www.gemtec.ca | ottawa@gemtec.ca

CORE 19

Project CONCRETE CORE LOGGING & TEST RESULTS
 OLD RAILWAY RIDEAU RIVER BRIDGE (SN 018600)
 OTTAWA, ONTARIO

Project No.
 63333.36

FIGURE 19

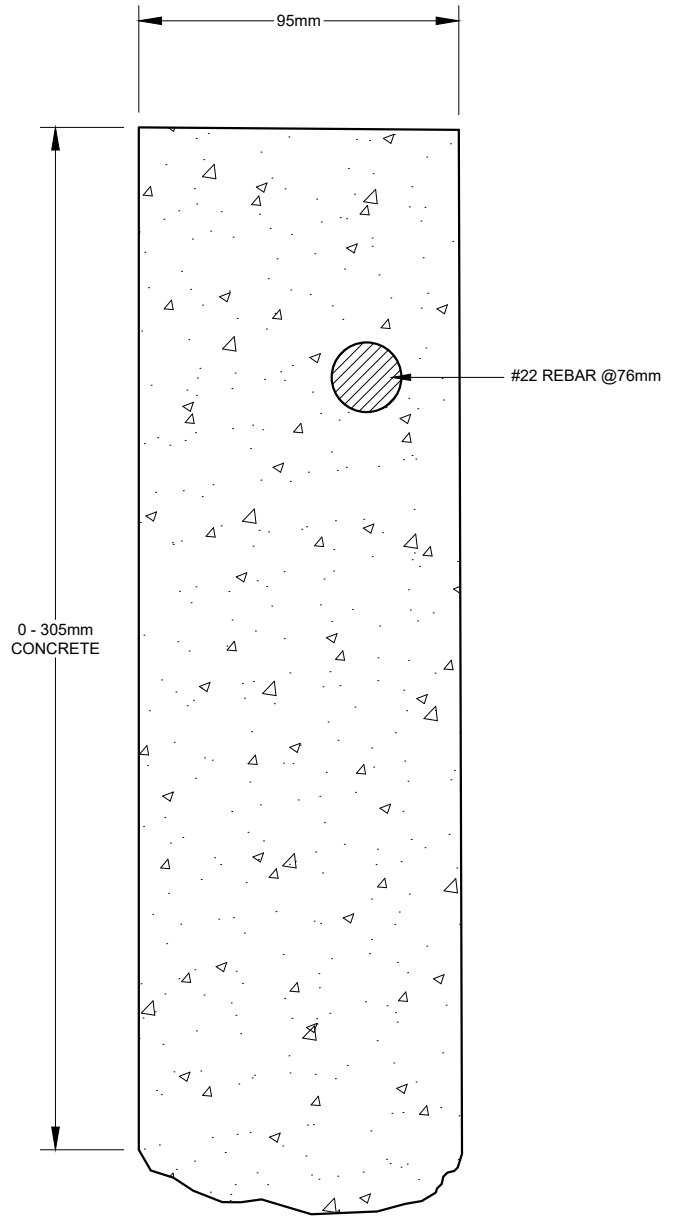
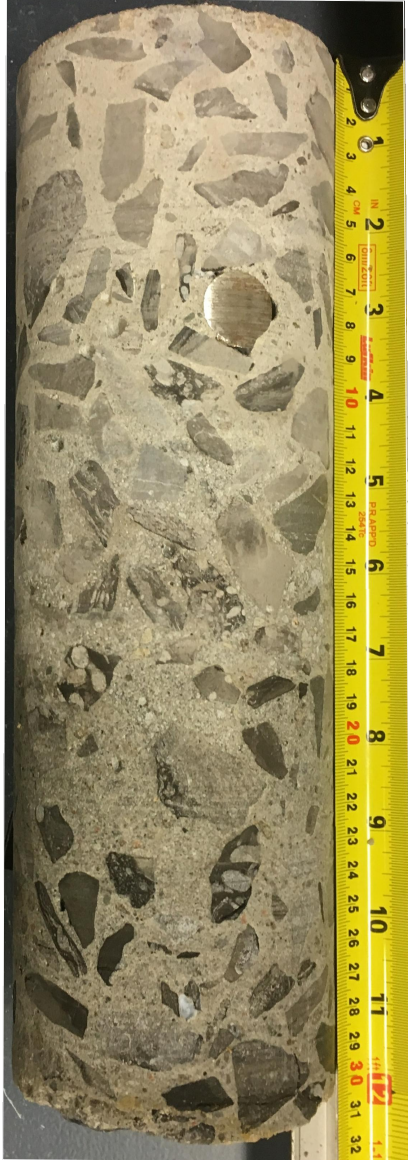

32 Steacie Drive, Ottawa, ON K2K 2A9
T: (613) 836-1422 | www.gemtec.ca | ottawa@gemtec.ca

CORE 20

Project CONCRETE CORE LOGGING & TEST RESULTS
OLD RAILWAY RIDEAU RIVER BRIDGE (SN 018600)
OTTAWA, ONTARIO

Project No.
63333.36

FIGURE 20

CORE LOG FOR EXPOSED CONCRETESITE NO. 018600Component Type and Location Old Railway Rideau River Bridge

Core No.		1	2	3			
Location		East Abutment	East Abutment	E. Abutment Wing Wall			
Diameter, mm		95	95	95			
Length, mm		584	342	305			
Full Depth (Yes/No)		No	No	No			
Defects in Concrete (1)		C + D + Sc	C + D + Sc	C + D + Sc			
Condition of Rebar (2)		n/a	n/a	SR			
Corrosion Potential (At Closest Grid Point)		n/a	n/a	n/a			
Compressive Strength, MPa		24.8	13.6	n/a			
Chloride Content % Chloride by Weight of Concrete		Total	Corrected	Total	Corrected	Total	Corrected
	0-10mm					0.138	0.111
	20-30mm					0.104	0.077
	40-50mm					0.097	0.070
	60-70mm					0.084	0.057
	80-90mm					0.072	0.045
Air Voids	Air Content, %						
	Spec. Surf., mm ² /mm ³						
	Spacing Factor, mm						
Test Laboratory		GEMTEC	GEMTEC	GEMTEC			
Remarks		Delamination @ 90 mm Weathering from 0 to 165 mm Compressive strength specimen from 200 to 400 mm	Delamination @ 178 mm Break @ 235 mm Crack @ 180 mm Compressive strength specimen from 0 to 140 mm	Delamination / break @ 100 mm Corrected chloride value of 0.027 selected from Core 20 results #22 rebar @ 100 mm with severe rusting			

1. Defects - C = Cracked, D = Delamination, R = Rough, Sc = Scaling, S = Spalling
2. Condition Rebar - LR = Light Rust, SR = Severe Rust, N/A - No rebar exposed

CORE LOG FOR EXPOSED CONCRETESITE NO. 018600Component Type and Location Old Railway Rideau River Bridge

Core No.		4	5	6			
Location		Pier 1 East Side	Pier 1 West Side	Pier 2 East Side			
Diameter, mm		95	95	95			
Length, mm		406	635	550			
Full Depth (Yes/No)		No	No	No			
Defects in Concrete (1)		C + S	n/a	D			
Condition of Rebar (2)		n/a	n/a	n/a			
Corrosion Potential (At Closest Grid Point)		n/a	n/a	n/a			
Compressive Strength, MPa		n/a	39.1 / 91.4	21.8			
Chloride Content % Chloride by Weight of Concrete		Total	Corrected	Total	Corrected	Total	Corrected
	0-10mm						
	20-30mm						
	40-50mm						
	60-70mm						
80-90mm							
Air Voids	Air Content, %						
	Spec. Surf., mm ² /mm ³						
	Spacing Factor, mm						
Test Laboratory		GEMTEC	GEMTEC	GEMTEC			
Remarks		Vertical and horizontal cracking over full depth of core.	0 to 400 mm is PCC (39.1 MPa) 400 to 635 mm appears to be stone with compressive strength of 91.4 MPa	0 to 80 mm is fine (sand) PCC 80 to 300 appears to be stone 300 to 550 mm is PCC			

1. Defects - C = Cracked, D = Delamination, R = Rough, Sc = Scaling, S = Spalling
2. Condition Rebar - LR = Light Rust, SR = Severe Rust, N/A - No rebar exposed

CORE LOG FOR EXPOSED CONCRETE

SITE NO. 018600

Component Type and Location Old Railway Rideau River Bridge

Core No.		7	8	9			
Location		Pier 2 West Side	Pier 3 East Side	Pier 3 West Side			
Diameter, mm		95	95	95			
Length, mm		368	356	622			
Full Depth (Yes/No)		No	No	No			
Defects in Concrete (1)		S	D + Sc	D			
Condition of Rebar (2)		n/a	LR	n/a			
Corrosion Potential (At Closest Grid Point)		n/a	n/a	n/a			
Compressive Strength, MPa		21.4	41.9	34.8			
Chloride Content % Chloride by Weight of Concrete		Total	Corrected	Total	Corrected	Total	Corrected
	0-10mm	/	/	/	/	/	/
	20-30mm	/	/	/	/	/	/
	40-50mm	/	/	/	/	/	/
	60-70mm	/	/	/	/	/	/
80-90mm	/	/	/	/	/	/	
Air Voids	Air Content, %	/	/	/	/	/	/
	Spec. Surf., mm ² /mm ³	/	/	/	/	/	/
	Spacing Factor, mm	/	/	/	/	/	/
Test Laboratory		GEMTEC	GEMTEC	GEMTEC			
Remarks		0 to 130 mm is fine (sand) PCC 130 to 330 mm (variable) appears to be stone 170 to 368 mm (variable) is PCC Compressive strength of sand concrete.	Break @ 175 mm Compressive strength specimen from 0 to 138 mm #22 rebar @ 265 mm	Break @ 330 mm Compressive strength specimen from 340 to 530 mm			

1. Defects - C = Cracked, D = Delamination, R = Rough, Sc = Scaling, S = Spalling
2. Condition Rebar - LR = Light Rust, SR = Severe Rust, N/A - No rebar exposed

CORE LOG FOR EXPOSED CONCRETESITE NO. 018600Component Type and Location Old Railway Rideau River Bridge

Core No.		10	11	12			
Location		Pier 4 East Side	Pier 4 West Side	Pier 5 East Side			
Diameter, mm		95	95	95			
Length, mm		610	343	343			
Full Depth (Yes/No)		No	No	No			
Defects in Concrete (1)		D + C	C + D + S	S			
Condition of Rebar (2)		n/a	LR	LR			
Corrosion Potential (At Closest Grid Point)		n/a	n/a	n/a			
Compressive Strength, MPa		18.9	14.0	38.8			
Chloride Content % Chloride by Weight of Concrete		Total	Corrected	Total	Corrected	Total	Corrected
	0-10mm	/		/		/	
	20-30mm						
	40-50mm						
	60-70mm						
80-90mm							
Air Voids	Air Content, %	/		/		/	
	Spec. Surf., mm ² /mm ³						
	Spacing Factor, mm						
Test Laboratory		GEMTEC	GEMTEC	GEMTEC			
Remarks		Break @ 483 mm 0 to 483 is PCC 483 to 610 mm appears to be stone Compressive strength specimen from 280 to 483 mm	Break @ #22 Rebar @ 196 mm Compressive strength specimen from 0 to 115 mm	# 22 Rebar @ 114 and 140 mm Compressive strength specimen from 0 to 162 mm			

1. Defects - C = Cracked, D = Delamination, R = Rough, Sc = Scaling, S = Spalling
2. Condition Rebar - LR = Light Rust, SR = Severe Rust, N/A - No rebar exposed

CORE LOG FOR EXPOSED CONCRETE

SITE NO. 018600

Component Type and Location Old Railway Rideau River Bridge

Core No.		13	14	15			
Location		Pier 5 West Side	Pier 6 East Side	Pier 6 West Side			
Diameter, mm		95	95	95			
Length, mm		610	660	368			
Full Depth (Yes/No)		No	No	No			
Defects in Concrete (1)		n/a	S + D	D			
Condition of Rebar (2)		LR	LR	LR			
Corrosion Potential (At Closest Grid Point)		n/a	n/a	n/a			
Compressive Strength, MPa		38.0	48.0	41.3			
Chloride Content % Chloride by Weight of Concrete		Total	Corrected	Total	Corrected	Total	Corrected
	0-10mm	/		/		/	
	20-30mm						
	40-50mm						
	60-70mm						
80-90mm							
Air Voids	Air Content, %	/		/		/	
	Spec. Surf., mm ² /mm ³						
	Spacing Factor, mm						
Test Laboratory		GEMTEC	GEMTEC	GEMTEC			
Remarks		#22 Rebar @ 114 (longitudinal) and 140 mm (transverse) Compressive strength specimen from 200 to 390 mm	#22 Rebar @ 76 mm Compressive strength specimen from 0 to 194 mm 0 to 500 mm is PCC 500 to 660 appears to be stone	#22 Rebar (2) @ 108 mm overlapping Break at rebar depth Compressive strength specimen from 130 to 320 mm			

1. Defects - C = Cracked, D = Delamination, R = Rough, Sc = Scaling, S = Spalling
2. Condition Rebar - LR = Light Rust, SR = Severe Rust, N/A - No rebar exposed

CORE LOG FOR EXPOSED CONCRETE

Component Type and Location Old Railway Rideau River Bridge

Core No.		16	17	18			
Location		Pier 7 East Side	Pier 7 West Side	West Abutment			
Diameter, mm		95	95	95			
Length, mm		380	635	610			
Full Depth (Yes/No)		No	No	No			
Defects in Concrete (1)		C + D	D	D + C			
Condition of Rebar (2)		LR	LR	LR			
Corrosion Potential (At Closest Grid Point)		n/a	n/a	n/a			
Compressive Strength, MPa		15.2	26.9	29.0			
Chloride Content % Chloride by Weight of Concrete		Total	Corrected	Total	Corrected	Total	Corrected
	0-10mm	/		/		/	
	20-30mm						
	40-50mm						
	60-70mm						
80-90mm							
Air Voids	Air Content, %	/		/		/	
	Spec. Surf., mm ² /mm ³						
	Spacing Factor, mm						
Test Laboratory		GEMTEC	GEMTEC	GEMTEC			
Remarks		#22 Rebar (2) @ 127 mm Crack/break @ 95 mm Compressive strength specimen from 150 to 345 mm	#22 Rebar @ 152 mm, Mesh @ 508 mm 0 to 533 is PCC 533 to 635 appears to be stone Compressive strength specimen from 0 to 195 mm	#22 Rebar @ 100 mm, Break @ 533 mm 0 to 533 is PCC, 533 to 610 appears to be stone with vertical crack Compressive strength specimen from 180 to 380 mm			

1. Defects - C = Cracked, D = Delamination, R = Rough, Sc = Scaling, S = Spalling
2. Condition Rebar - LR = Light Rust, SR = Severe Rust, N/A - No rebar exposed

CORE LOG FOR EXPOSED CONCRETE

SITE NO. 018600

Component Type and Location Old Railway Rideau River Bridge

Core No.		19		20			
Location		West Abutment		W. Abutment Wing Wall			
Diameter, mm		95		95			
Length, mm		381		305			
Full Depth (Yes/No)		No		No			
Defects in Concrete (1)		n/a		n/a			
Condition of Rebar (2)		LR		LR			
Corrosion Potential (At Closest Grid Point)		n/a		n/a			
Compressive Strength, MPa		53.2		n/a			
Chloride Content % Chloride by Weight of Concrete		Total	Corrected	Total	Corrected	Total	Corrected
	0-10mm			0.180	0.153		
	20-30mm			0.122	0.095		
	40-50mm			0.045	0.018		
	60-70mm			0.027	0.000		
	80-90mm			0.031	0.004		
Air Voids	Air Content, %						
	Spec. Surf., mm²/mm³						
	Spacing Factor, mm						
Test Laboratory		GEMTEC		GEMTEC			
Remarks		#22 Rebar @ 101 mm Compressive strength specimen from 0 to 190 mm		#22 Rebar @ 76 mm			

1. Defects - C = Cracked, D = Delamination, R = Rough, Sc = Scaling, S = Spalling
2. Condition Rebar - LR = Light Rust, SR = Severe Rust, N/A - No rebar exposed

**COMPRESSIVE STRENGTH
of CONCRETE CORE**

GEMTEC Consulting Engineers and
Scientists Limited
32 Steacie Drive
Ottawa, ON
K2K 2A9
Tel.: 613-836-1422
Fax.:613-836-9731

CLIENT: Parsons Corporation
Project: Rideau River Bridge
Date Received: 14-Jun-18

PROJECT No.: 63333.36
REPORT NO: 1
Date Tested: 22-Jun-18

Lab no.	n/a	n/a	n/a	n/a	n/a	n/a
Core ID	1	2	5 Top	5 Bottom	6	7
Depth (m)	-	-	-	-	-	-
Cut length (mm)	201.19	140.83	200.81	181.45	151.88	126.16
Ground length (mm)	196.57	139.37	195.68	175.24	143.06	116.60
Diameter (mm)	94.82	96.53	93.68	93.89	94.87	95.91
Ground Mass (g)	3246.00	2430.00	3250.00	3255.00	2265.00	2044.00
Length:Diameter ratio	2.07	1.44	2.09	1.87	1.51	1.22
Correction factor	1.01	0.95	1.01	0.99	0.96	0.92
Failure load (kN)	173.40	104.77	266.52	639.17	160.41	168.08
Uncorrected Strength (MPa)	24.60	14.30	38.70	92.30	22.70	23.30
Corrected Strength (MPa)	24.80	13.60	39.10	91.40	21.80	21.40

Remarks

Checked by:

Krystle Smith, Laboratory Manager

Reviewed by:

Steve Goodman, Ph.D., P.Eng.



**COMPRESSIVE STRENGTH
of CONCRETE CORE**

CLIENT: Parsons Corporation
Project: Rideau River Bridge
Date Received: 14-Jun-18

PROJECT No.: 63333.36
REPORT NO: 1
Date Tested: 22-Jun-18

Lab no.	n/a	n/a	n/a	n/a	n/a	n/a
Core ID	8	9	10	11	12	13
Depth (m)	-	-	-	-	-	-
Cut length (mm)	137.99	189.83	204.45	115.84	162.12	191.67
Ground length (mm)	132.50	181.32	203.41	113.08	154.80	191.42
Diameter (mm)	96.52	95.38	93.86	96.49	95.55	93.96
Ground Mass (g)	2336.00	3153.00	3388.00	1984.00	2714.00	3238.00
Length:Diameter ratio	1.37	1.90	2.17	1.17	1.62	2.04
Correction factor	0.95	0.99	1.02	0.91	0.97	1.00
Failure load (kN)	322.57	251.73	127.79	112.31	286.50	263.80
Uncorrected Strength (MPa)	44.10	35.20	18.50	15.40	40.00	38.00
Corrected Strength (MPa)	41.90	34.80	18.90	14.00	38.80	38.00

Remarks

Checked by:

Krystle Smith, Laboratory Manager

Reviewed by:

Steve Goodman, Ph.D., P.Eng.

**COMPRESSIVE STRENGTH
of CONCRETE CORE**

GEMTEC Consulting Engineers and
Scientists Limited
32 Steacie Drive
Ottawa, ON
K2K 2A9
Tel.: 613-836-1422
Fax.:613-836-9731

CLIENT: Parsons Corporation
Project: Rideau River Bridge
Date Received: 14-Jun-18

PROJECT No.: 63333.36
REPORT NO: 1
Date Tested: 22-Jun-18

Lab no.	n/a	n/a	n/a	n/a	n/a	n/a
Core ID	14	15	16	17	18	19
Depth (m)	-	-	-	-	-	-
Cut length (mm)	194.03	189.87	195.49	197.69	201.35	190.70
Ground length (mm)	188.38	183.52	192.00	194.15	201.13	187.23
Diameter (mm)	94.78	96.16	96.81	96.56	94.55	96.35
Ground Mass (g)	3182.00	3252.00	3273.00	3247.00	3395.00	3316.00
Length:Diameter ratio	1.99	1.91	1.98	2.01	2.13	1.94
Correction factor	1.00	0.99	1.00	1.00	1.01	0.99
Failure load (kN)	338.82	303.19	112.20	196.94	201.37	391.87
Uncorrected Strength (MPa)	48.00	41.70	15.20	26.90	28.70	53.70
Corrected Strength (MPa)	48.00	41.30	15.20	26.90	29.00	53.20

Remarks

Checked by:

Krystle Smith, Laboratory Manager

Reviewed by:

Steve Goodman, Ph.D., P.Eng.



Report ID: 279612-IAS
Report Date: 18-Jul-18
Date Received: 04-Jul-18

CERTIFICATE OF ANALYSIS

for
Gemtec Limited
191 Doak Road
Fredericton, NB E3C 2E6

rpc

921 College Hill Rd
Fredericton NB
Canada E3B 6Z9
Tel: 506.452.1212
Fax: 506.452.0594
www.rpc.ca

Attention: Warren Mawhinney

Project #: 63333.36

Location: Old Railway Rideau River Bridge

Analysis of Samples

Analytes:		Chloride
Units:		mg/kg
RL:		10
RPC Sample ID	Client Sample ID	
279612-01	Core 3; 0-10	1380
279612-01 Dup	Lab Duplicate	1380
279612-02	Core 3; 20-30	1040
279612-03	Core 3; 40-50	970
279612-04	Core 3; 60-70	840
279612-05	Core 3; 80-90	720
279612-06	Core 20; 0-10	1800
279612-07	Core 20; 20-30	1220
279612-08	Core 20; 40-50	450
279612-09	Core 20; 60-70	270
279612-10	Core 20; 80-90	310

This report relates only to the sample(s) and information provided to the laboratory.

RL = Reporting Limit



Ross Kean
Department Head
Inorganic Analytical Chemistry

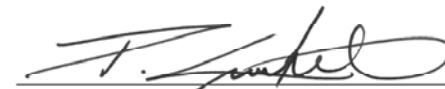

Peter Crowhurst
Analytical Chemist
Inorganic Analytical Chemistry

CHEMISTRY

Page 1 of 2

Report ID: 279612-IAS
Report Date: 18-Jul-18
Date Received: 04-Jul-18

CERTIFICATE OF ANALYSIS

for
Gemtec Limited
191 Doak Road
Fredericton, NB E3C 2E6

rpc

921 College Hill Rd
Fredericton NB
Canada E3B 6Z9
Tel: 506.452.1212
Fax: 506.452.0594
www.rpc.ca

General Report Comments

The samples were pulverized and portions were leached in boiling de-ionized water.
Chloride was determined colourimetrically.

COMMENTS

Page 2 of 2

APPENDIX F

Structural Steel Coating Analysis Results

Certificate of Analysis

Parsons (Ottawa)

1223 Michael St
Ottawa, ON K1J 7T2
Attn: Patrick Mergel

Client PO:
Project: Rideau River Pedestrian Bridge ROA
Custody: 43275

Report Date: 27-Jun-2018
Order Date: 21-Jun-2018

Order #: 1825668

This Certificate of Analysis contains analytical data applicable to the following samples as submitted:

Parcel ID	Client ID
1825668-01	Span 1- Cross Frame
1825668-02	Span 2- Girder (Interior)
1825668-03	Span 3- Girder (Interior)
1825668-04	Span 4- Cross Frame
1825668-05	Span 5- North Girder (Int. Web)
1825668-06	Span 6- Cross Frame
1825668-07	Span 7- Cross Frame
1825668-08	Span 8- Lateral Brace

Approved By:



Dale Robertson, BSc
Laboratory Director

Certificate of Analysis
Client: Parsons (Ottawa)
Client PO:

Report Date: 27-Jun-2018

Order Date: 21-Jun-2018

Project Description: Rideau River Pedestrian Bridge ROA

Analysis Summary Table

Analysis	Method Reference/Description	Extraction Date	Analysis Date
Mercury by CVAA	EPA 7471B - CVAA, digestion	27-Jun-18	27-Jun-18
Metals, ICP-MS	EPA 6020 - Digestion - ICP-MS	27-Jun-18	27-Jun-18

Certificate of Analysis

Report Date: 27-Jun-2018

Client: Parsons (Ottawa)

Order Date: 21-Jun-2018

Client PO:

Project Description: Rideau River Pedestrian Bridge ROA

Client ID:	Span 1- Cross Frame	Span 2- Girder (Interior)	Span 3- Girder (Interior)	Span 4- Cross Frame
Sample Date:	06/12/2018 13:00	06/12/2018 13:00	06/12/2018 13:00	06/12/2018 13:00
Sample ID:	1825668-01	1825668-02	1825668-03	1825668-04
MDL/Units	Paint	Paint	Paint	Paint

Metals					
	MDL/Units	Span 1- Cross Frame	Span 2- Girder (Interior)	Span 3- Girder (Interior)	Span 4- Cross Frame
Aluminum	500 ug/g	1100	1400	1950	1830
Antimony	50 ug/g	<50	<50	<50	<50
Arsenic	50 ug/g	<50	<50	<50	<50
Barium	500 ug/g	10600	11400	11200	10000
Beryllium	50 ug/g	<50	<50	<50	<50
Boron	500 ug/g	<500	<500	<500	<500
Cadmium	50 ug/g	68	<50	56	<50
Chromium	500 ug/g	<500	<500	<500	<500
Cobalt	200 ug/g	<200	<200	<200	<200
Copper	500 ug/g	<500	<500	<500	<500
Iron	10000 ug/g	37900	53000	59300	44500
Lead	5 ug/g	227000	109000	118000	98000
Manganese	200 ug/g	241	<200	246	251
Mercury	2 ug/g	39	86	96	70
Molybdenum	50 ug/g	<50	<50	<50	<50
Nickel	200 ug/g	<200	<200	<200	<200
Selenium	50 ug/g	<50	<50	<50	<50
Silver	50 ug/g	<50	<50	<50	<50
Strontium	500 ug/g	<500	<500	<500	<500
Thallium	50 ug/g	<50	<50	<50	<50
Tin	500 ug/g	<500	<500	<500	<500
Titanium	500 ug/g	<500	<500	<500	<500
Uranium	50 ug/g	<50	<50	<50	<50
Vanadium	500 ug/g	<500	<500	<500	<500
Zinc	1000 ug/g	32200	16800	21700	16800

Certificate of Analysis

Report Date: 27-Jun-2018

Client: Parsons (Ottawa)

Order Date: 21-Jun-2018

Client PO:

Project Description: Rideau River Pedestrian Bridge ROA

	Client ID:	Span 5- North Girder (Int. Web)	Span 6- Cross Frame	Span 7- Cross Frame	Span 8- Lateral Brace
	Sample Date:	06/12/2018 13:00	06/12/2018 13:00	06/12/2018 13:00	06/13/2018 13:00
	Sample ID:	1825668-05	1825668-06	1825668-07	1825668-08
	MDL/Units	Paint	Paint	Paint	Paint
Metals					
Aluminum	500 ug/g	1480	2040	1600	693
Antimony	50 ug/g	<50	<50	<50	107
Arsenic	50 ug/g	<50	<50	<50	<50
Barium	500 ug/g	10700	17000	13100	14100
Beryllium	50 ug/g	<50	<50	<50	<50
Boron	500 ug/g	<500	<500	<500	<500
Cadmium	50 ug/g	<50	<50	56	<50
Chromium	500 ug/g	<500	<500	<500	<500
Cobalt	200 ug/g	<200	<200	<200	<200
Copper	500 ug/g	<500	<500	<500	<500
Iron	10000 ug/g	41400	51100	52700	49300
Lead	5 ug/g	118000	135000	97400	255000
Manganese	200 ug/g	241	246	262	337
Mercury	2 ug/g	43	62	46	25
Molybdenum	50 ug/g	<50	<50	<50	<50
Nickel	200 ug/g	<200	<200	<200	<200
Selenium	50 ug/g	<50	<50	<50	<50
Silver	50 ug/g	<50	<50	<50	<50
Strontium	500 ug/g	<500	530	<500	<500
Thallium	50 ug/g	<50	<50	<50	<50
Tin	500 ug/g	<500	<500	<500	<500
Titanium	500 ug/g	<500	<500	<500	<500
Uranium	50 ug/g	<50	<50	<50	<50
Vanadium	500 ug/g	<500	<500	<500	<500
Zinc	1000 ug/g	27000	<10000	21200	26900

Certificate of Analysis

Report Date: 27-Jun-2018

Client: Parsons (Ottawa)

Order Date: 21-Jun-2018

Client PO:

Project Description: Rideau River Pedestrian Bridge ROA

Method Quality Control: Blank

Analyte	Result	Reporting Limit	Units	Source Result	%REC	%REC Limit	RPD	RPD Limit	Notes
Metals									
Aluminum	ND	500	ug/g						
Antimony	ND	50	ug/g						
Arsenic	ND	50	ug/g						
Barium	ND	500	ug/g						
Beryllium	ND	50	ug/g						
Boron	ND	500	ug/g						
Cadmium	ND	50	ug/g						
Chromium	ND	500	ug/g						
Cobalt	ND	200	ug/g						
Copper	ND	500	ug/g						
Iron	ND	10000	ug/g						
Lead	ND	5	ug/g						
Mercury	ND	2	ug/g						
Manganese	ND	200	ug/g						
Molybdenum	ND	50	ug/g						
Nickel	ND	200	ug/g						
Selenium	ND	50	ug/g						
Silver	ND	50	ug/g						
Strontium	ND	500	ug/g						
Thallium	ND	50	ug/g						
Tin	ND	500	ug/g						
Titanium	ND	500	ug/g						
Uranium	ND	50	ug/g						
Vanadium	ND	500	ug/g						
Zinc	ND	1000	ug/g						

Certificate of Analysis

Report Date: 27-Jun-2018

Client: Parsons (Ottawa)

Order Date: 21-Jun-2018

Client PO:

Project Description: Rideau River Pedestrian Bridge ROA

Method Quality Control: Duplicate

Analyte	Result	Reporting Limit	Units	Source Result	%REC	%REC Limit	RPD	RPD Limit	Notes
Metals									
Aluminum	1100	500	ug/g	1100			0.1	50	
Antimony	51.4	50	ug/g	ND			0.0	50	
Arsenic	ND	50	ug/g	ND			0.0	50	
Barium	10700	500	ug/g	10600			1.4	50	
Beryllium	ND	50	ug/g	ND			0.0	50	
Boron	ND	500	ug/g	ND			0.0	50	
Cadmium	66.8	50	ug/g	68.3			2.1	50	
Chromium	ND	500	ug/g	ND			0.0	50	
Cobalt	ND	200	ug/g	ND			0.0	50	
Copper	ND	500	ug/g	ND			0.0	50	
Iron	36700	10000	ug/g	37900			3.1	50	
Mercury	39	2	ug/g	39			0.8	30	
Manganese	234	200	ug/g	241			3.1	50	
Molybdenum	ND	50	ug/g	ND			0.0	50	
Nickel	ND	200	ug/g	ND			0.0	50	
Selenium	ND	50	ug/g	ND			0.0	50	
Silver	ND	50	ug/g	ND			0.0	50	
Strontium	ND	500	ug/g	ND			0.0	50	
Thallium	ND	50	ug/g	ND			0.0	50	
Tin	ND	500	ug/g	ND			0.0	50	
Titanium	ND	500	ug/g	ND			0.0	50	
Uranium	ND	50	ug/g	ND			0.0	50	
Vanadium	ND	500	ug/g	ND			0.0	50	
Zinc	32100	1000	ug/g	32200			0.6	50	

Certificate of Analysis

Report Date: 27-Jun-2018

Client: Parsons (Ottawa)

Order Date: 21-Jun-2018

Client PO:

Project Description: Rideau River Pedestrian Bridge ROA

Method Quality Control: Spike

Analyte	Result	Reporting Limit	Units	Source Result	%REC	%REC Limit	RPD	RPD Limit	Notes
Metals									
Aluminum	90		ug/L	ND	92.7	70-130			
Antimony	48.1		ug/L	ND	92.8	70-130			
Arsenic	48.5		ug/L	ND	95.6	70-130			
Barium	482		ug/L	ND	116	70-130			
Beryllium	48.3		ug/L	ND	96.7	70-130			
Boron	47		ug/L	ND	93.2	70-130			
Cadmium	49.5		ug/L	ND	93.6	70-130			
Chromium	54.1		ug/L	ND	93.8	70-130			
Cobalt	49		ug/L	ND	94.1	70-130			
Copper	49		ug/L	ND	93.8	70-130			
Iron	2290		ug/L	ND	77.1	70-130			
Lead	49.2		ug/L		98.4	70-130			
Mercury	53	2	ug/g	39	94.0	70-130			
Manganese	57		ug/L	ND	93.9	70-130			
Molybdenum	45.1		ug/L	ND	89.8	70-130			
Nickel	47.6		ug/L	ND	93.5	70-130			
Selenium	47.0		ug/L	ND	93.9	70-130			
Silver	44.8		ug/L	ND	89.5	70-130			
Strontium	58		ug/L	ND	92.3	70-130			
Thallium	45.3		ug/L	ND	90.6	70-130			
Tin	46.5		ug/L	ND	91.3	70-130			
Titanium	50		ug/L	ND	94.4	70-130			
Uranium	49.1		ug/L	ND	98.1	70-130			
Vanadium	47		ug/L	ND	92.9	70-130			
Zinc	50		ug/L		101	70-130			

Certificate of Analysis

Client: **Parsons (Ottawa)**

Client PO:

Report Date: 27-Jun-2018

Order Date: 21-Jun-2018

Project Description: **Rideau River Pedestrian Bridge ROA**

Qualifier Notes:

None

Sample Data Revisions

None

Work Order Revisions / Comments:

None

Other Report Notes:

n/a: not applicable

ND: Not Detected

MDL: Method Detection Limit

Source Result: Data used as source for matrix and duplicate samples

%REC: Percent recovery.

RPD: Relative percent difference.

Exova
2395 Speakman Drive
Mississauga
Ontario
Canada
L5K 1B3

T: +1 (905) 822-4111
F: +1 (905) 823-1446
E: info@exova.com
W: www.exova.com



Testing, calibrating, advising

Identification Analysis

2018-07-26

Parsons Inc.
Suite 100-1223 Michael Street
Ottawa, Ontario K1J 7T2

Exova Job No: 74457
Purchase Order: VISA
Exova Report No: 49629 Version 1

Attn: Mina Sedarous
Email: mina.sedarous@parsons.com

A stylized, handwritten signature in black ink, appearing to read "B Wickson".

Bryan Wickson, Manager

Graphical representation of electronic signature.
Document approved: 2018-07-26

A handwritten signature in black ink, appearing to read "Brian White".

Brian White, Sr Scientist

Graphical representation of electronic signature.
Document approved: 2018-07-26

1.0 INTRODUCTION

One paint chip sample consisting of five layers was submitted for generic identification of the polymeric binder in each layer. The analysis was carried out using Fourier transform infrared (FTIR) spectroscopy.

The sample was assigned the following Exova ID number:

<u>Client Identification</u>	<u>Exova Sample Number</u>
Old Railway Pedestrian Bridge over Rideau River Span # 7 Cross Frame	18-74457-236968

2.0 EXPERIMENTAL

All raw data is referenced in Lab Book Number 15064. With the aid of a Nikon SMZ1500 stereomicroscope (Asset# A15422), the five layers were sampled for analysis.

The submitted sample consisted of five layers (from top to bottom): orange, white, dark grey/black, orange, dark grey/black (Figure 1). The orange and white layers were soft and resin/paint-like in appearance. When scraped the dark grey/black layers were harder and powder-like in consistency.

The analysis of each paint layer received 'as received' was carried out using a Nicolet 6700 Fourier transform infrared (FTIR) spectrometer (MII# A16201, calibration valid until 2018-10-20) equipped with a Smart Orbit single reflection horizontal ATR accessory (Asset# 16201) with a diamond internal reflection element at 45°. The sub-surface of each layer was analyzed to obtain a spectrum that was free of any contaminants (e.g. dirt).

For the layers that required pyrolysis due to high inorganic content, the pyrolysis spectra were obtained with the FTIR equipped with a Continuum microscope accessory (Asset# 16203) operating in transmission mode. Pyrolysis involves heating the sample in a micro tube until the organic portion thermally degrades, volatilizes, and condenses on the sides of the tube. The organic condensate; free from inorganic fillers was then analyzed on a KCl disc. Copies of the infrared spectra are shown in Appendix A.

3.0 RESULTS AND DISCUSSION

A schematic diagram of the different paint layers in the submitted sample is shown in Figure 1.

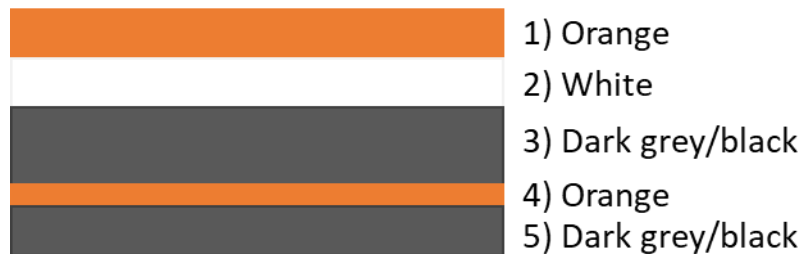

Figure 1: Cross sectional overview of the five layers of the paint chip.

Spectrum #1 (Figure 1, layer 1) represents the outer orange layer. Overall the spectrum shows intense absorbance bands indicating the presence of a polyester based hydrocarbon, as shown by the presence of carbonyl groups (e.g. esters, carboxylic acids) and hydroxyl groups. There are also intense absorbance bands attributed to inorganic components, such as silicates (e.g. sand, quartz) and carbonates (e.g. calcium carbonate).

Spectrum #2 (Figure 1, layer 2) represents the middle white layer. Overall the spectrum was very similar to Spectrum #1; there were intense absorbances associated with an organic polyester based hydrocarbon with peaks attributed to carbonyl and hydroxyl groups, as well as intense absorbances associated with inorganic components such as carbonates and silicates. The infrared peak assignments for these two layers are summarized in Table I.

Table I
Band Assignment for Layers 1-2

18-74457-236968	Wavenumber (cm ⁻¹)	Band Assignment
Layer 1 (Orange) Spectrum #1	2924, 2851, 722	Alkyl groups (part of alkyd resins)
	1738, 1710	Carbonyl groups (ester and carboxylic acid respectively)
	1531	Inorganic based component
	1406, 876	Carbonates
	1098, 780, 773	Silicates (eg. sand, quartz)
	1169	Ester
	3397	Alcohol (hydroxyl group)
Layer 2 (White) Spectrum #2	2924, 2851, 1454, 722	Alkyl groups (part of alkyd resins)
	1738, 1705	Carbonyl groups (ester and carboxylic acid respectively)
	1547, 1532	Inorganic based component
	1409, 1398, 875	Carbonates
	1099, 746	Silicates (e.g. sand, quartz)
	1167	Ester
	3385	Alcohol (hydroxyl group)

As the spectra for these two layers were very similar and isolating each layer separately proved to be difficult, the two layers were pyrolyzed together. Spectrum #3 represents the organic condensate obtained from pyrolysis of the sample. The spectrum shows intense absorbance bands around 2900 cm⁻¹ indicating a hydrocarbon signature, as well as two medium strength absorbance bands near 1720 cm⁻¹. As carbonyl absorbances are unique to the type of carbonyl, the two bands at 1770 cm⁻¹ and 1710 cm⁻¹ were attributed to carbonyls from esters and carboxylic acids, respectively. Together, all of this information suggests that the resin is a hydrocarbon with ester linkages that had carboxylic acids and alcohols as the building blocks. As these layers of paint were applied prior to 1970, the technology used back then and the IR spectral results suggest that the paint resin used was alkyd

based as the starting materials to form the resin were fatty acids and polyols (e.g. glycerol). The pyrolyzate spectra was generically identified as a fatty acid, which further supports the peak assignments.

The pyrolyzate spectrum of the top two layers (Spectrum #3) was subtracted from Spectrum #1 of the 'as received' orange layer. The subtraction spectrum is represented by Spectrum #4. The subtraction spectrum was generically identified as containing predominantly carbonates and silicate fillers. The infrared peak assignments for the pyrolyzate of layers 1-2 and the subtraction result are summarized in Table II.

Table II
Band Assignment for Pyrolyzate and Subtraction Result for Layers 1-2

18-74457-236968	Wavenumber (cm ⁻¹)	Band Assignment
Pyrolyzate of Layers 1 & 2 Spectrum #3	2955, 2925, 2853, 1461, 1377, 721	Alkyl groups (part of alkyd resins)
	1736, 1764 & 1709	Carbonyl groups (ester and carboxylic acid respectively)
	1180	Ester
	3397	Alcohol (hydroxyl group)
Subtraction Spectrum (Layer 1 – Pyrolyzate L1&2) Spectrum #4	2973, 2940, 2915, 2864, 2848	Alkyl groups
	1531	Inorganic based component
	1404, 876, 713	Carbonates
	1097, 780, 681	Silicates (eg. sand, quartz)
	3386	Hydroxyl groups

Spectrum #5 (Figure 1 layer 3) represents the middle dark grey/black layer. Overall the spectrum shows intense absorbance bands indicating hydrocarbons, carbonyl groups and hydroxyl groups are present in this layer. There are also intense absorbance bands associated with inorganic components such as silicates (eg. talc, quartz, sand) and carbonates (eg. calcium carbonate).

Spectrum #6 represents the organic condensate obtained from the pyrolysis of the third layer of the paint chip. The spectrum shows intense absorbance bands around 2900 cm^{-1} attributed to hydrocarbons, as well as an intense absorbance band at 1709 cm^{-1} with a shoulder at 1737 cm^{-1} attributed to carboxylic acids and esters respectively. There is also the broad band near 3400 cm^{-1} from hydroxyl groups and the bands in the region of 1200 cm^{-1} which also indicate the presence of esters and carboxylic acids. Together, all of this suggests that the resin is similar to that of the previous two layers and is an organic polyester based hydrocarbon, such as an alkyd resin.

The pyrolyzate spectrum of the grey layer (Spectrum #6) was subtracted from Spectrum #5 of the 'as received' dark grey/black layer. The subtraction spectrum is represented by Spectrum #7. The subtraction spectrum was generically identified as containing predominantly talc, with other fillers such as carbonates also present in lesser amounts. The infrared peak assignments for the pyrolyzate and associated subtraction result of third layer are summarized in Table III.

Table III
Band Assignment for Layer 3 – 'As Is', Pyrolyzate and Subtraction Result

18-74457-236968	Wavenumber (cm^{-1})	Band Assignment
Pyrolyzate of Layer 3 Spectrum #6	2919, 2850, 1463, 1378, 1240, 720	Alkyl groups (part of alkyd resins)
	1709, 1770	Carbonyl groups (carboxylic acid)
	1187	Ester
	3346, 1411, 1115, 1049	Hydroxyl (alcohol, carboxylic acid)
Subtraction Spectrum (Layer 3 – Pyrolyzate L3) Spectrum #7	1632	Inorganic based component
	1393, 870	Carbonates
	3675, 1019, 795, 777, 692, 667	Silicates (eg, sand, quartz, talc). The bands at 3675 cm^{-1} and 667 cm^{-1} are characteristic peaks of talc.

Spectrum #8 (Figure 1 layer 4) represents the middle orange layer. Overall the spectrum shows the same absorbance bands as the previous spectra, which can be attributed to carbonyls, hydrocarbons and hydroxyl groups. There are also absorbances associated with inorganic components such as

silicates (eg. talc, quartz, sand) including characteristic peaks attributed to talc at 3675 cm^{-1} , 1015 cm^{-1} and 668 cm^{-1} . This suggests that this paint layer is also composed of an organic polyester based hydrocarbon such as an alkyd resin, and has silicates such as talc and other inorganic fillers (e.g. carbonates). Spectrum #9 (Figure 1 layer 5) represents the bottom dark grey/black layer. Overall the spectrum is similar to that of Spectrum #8 with hydrocarbons, carbonyl groups (eg. esters, carboxylic acids), hydroxyl groups and inorganic based components such as silicates (eg. talc, quartz, sand). Just like the previous layer, this suggests that the bottom dark grey/black paint layer is an alkyd resin, and has silicates such as talc as a filler.

4.0 CONCLUSIONS

Our findings are summarized below:

- As paint coatings were applied prior to the 1970's (based on client communication), the technology used then was most likely oil or alkyd based resins with lead or chromium as the corrosion inhibitor. FTIR however, is not able to detect inorganics so the presence of lead or chromium cannot be confirmed. SEM/EDS is recommended if determination of the inorganic portions of the paint layers is required.
- Layer 1 (Orange, Spectrum #1, #3 & #4) was generically identified as an alkyd resin with silicate and carbonate filler.
- Layer 2 (White, Spectrum #2, #3 & #4) was generically identified as an alkyd resin with silicate and carbonate filler.
- Layer 3 (Dark grey/black, Spectrum #5, #6 & #7) was generically identified as an alkyd resin with primarily talc and some carbonate filler.
- Layer 4 (Orange, Spectrum #8) was generically identified as an alkyd resin with primarily silicate (i.e. talc) and some carbonate filler.
- Layer 5 (Dark grey/black, Spectrum #9) was generically identified as an alkyd resin with primarily silicate (i.e. talc) and some other inorganic based filler.

APPENDIX A

FTIR Spectra

(9 Pages)

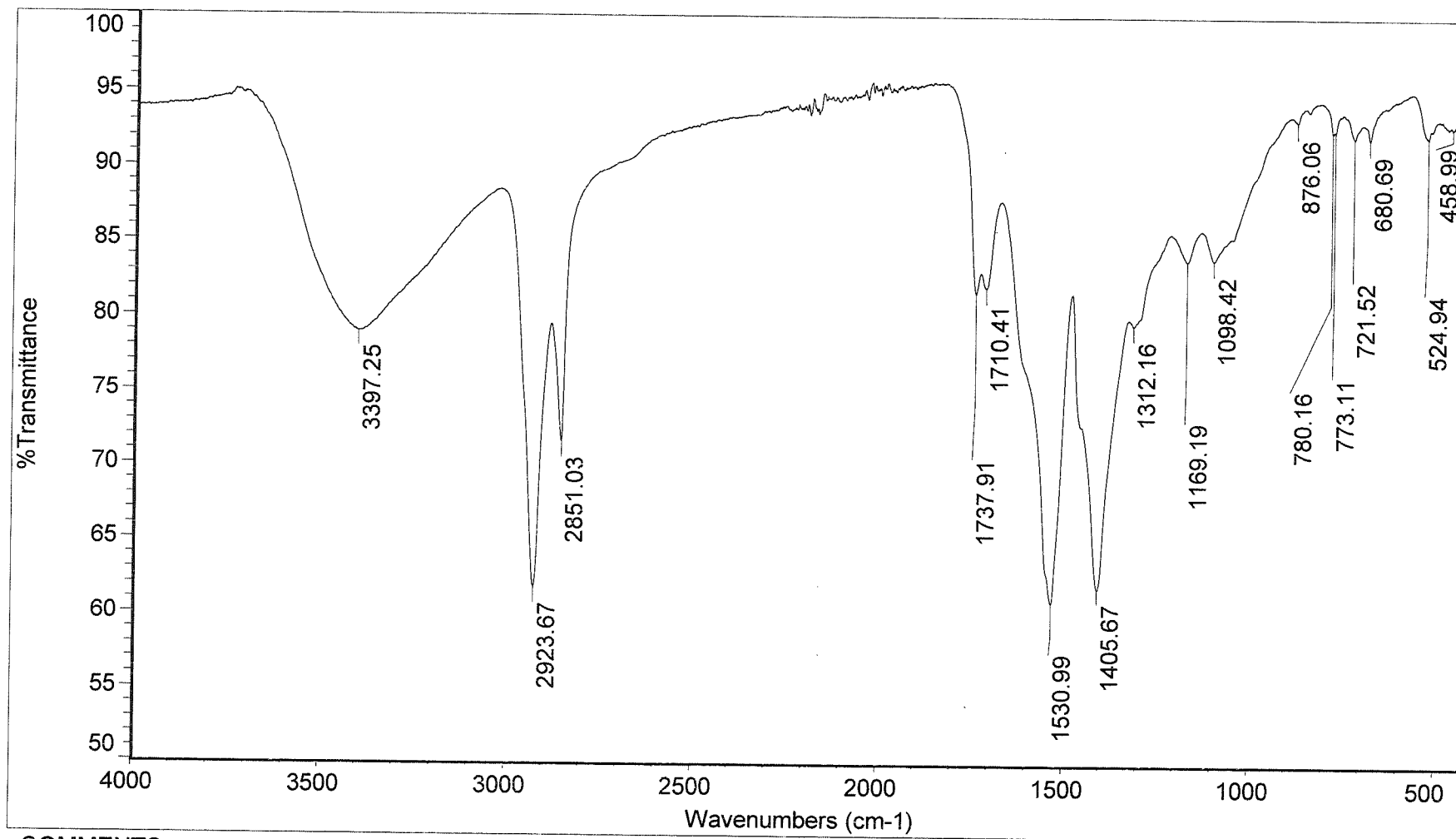

COMMENTS:

18-74457-236968
Old Railway Pedestrian Bridge over
Rideau River - Span #7 Cross Frame
orange layer (top)

FILENAME:

***187445701A

Collection time: Fri Jul 13 11:23:32 2018 (GMT-04:00)

USER NAME:

K. Pinto

EXPERIMENT INFORMATION:

Experiment filename: c:\my documents\omnic\param\OrbitDi.exp
Experiment title: Smart Orbit
Experiment accessory: Smart Orbit
Number of sample scans: 128
Number of background scans: 64
Resolution: 4.000
Sample gain: 8.0
Optical velocity: 0.6329
Aperture: 100.00

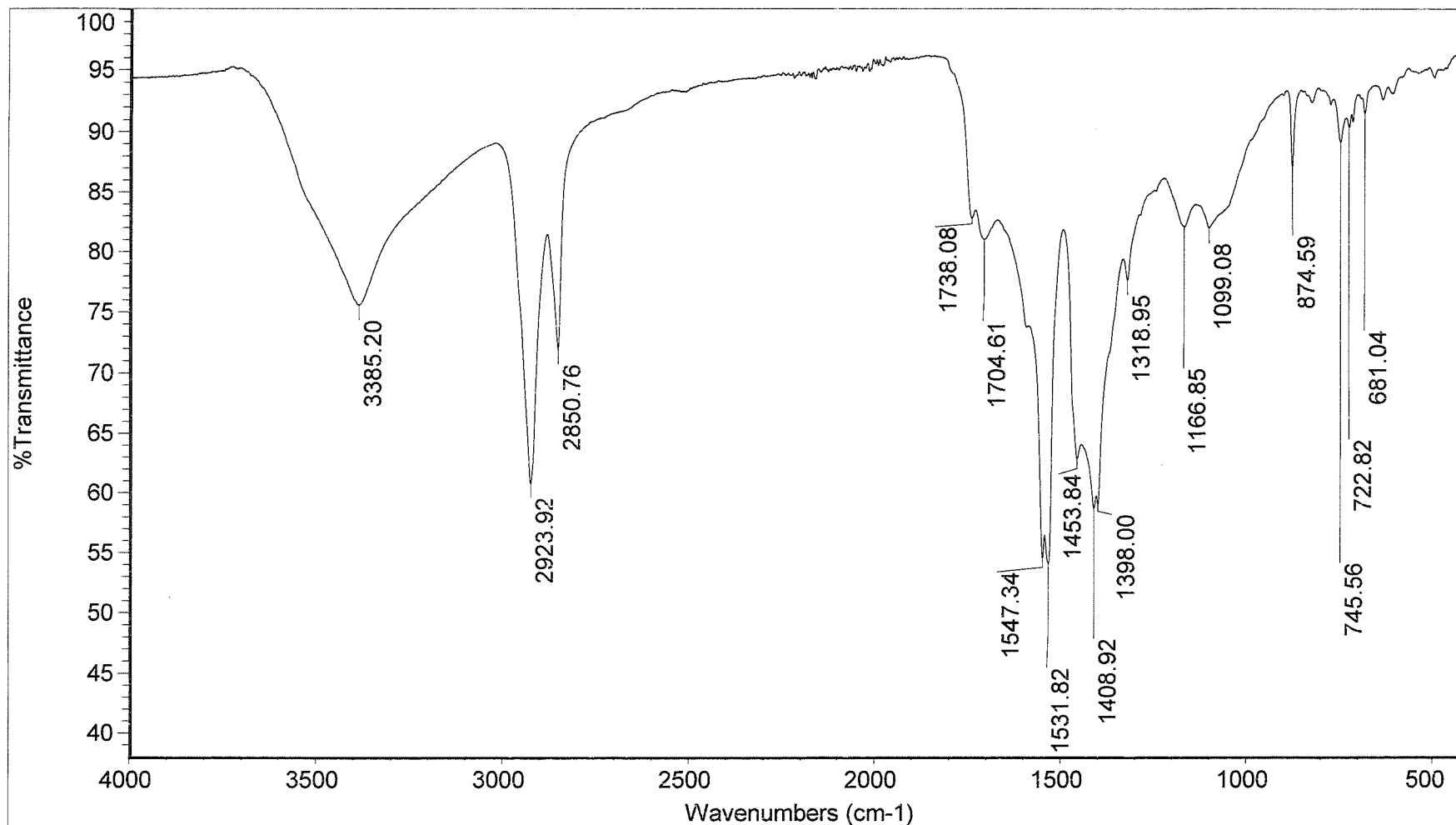

COMMENTS:

18-74457-236968
Old Railway Pedestrian Bridge over
Rideau River - Span #7 Cross Frame
white layer (middle)

FILENAME:

***187445701B

Collection time: Fri Jul 13 11:55:13 2018 (GMT-04:00)

USER NAME:

K. Pinto

EXPERIMENT INFORMATION:

Experiment filename: c:\my documents\omnic\param\OrbitDi.exp
Experiment title: Smart Orbit
Experiment accessory: Smart Orbit
Number of sample scans: 128
Number of background scans: 64
Resolution: 4.000
Sample gain: 8.0
Optical velocity: 0.6329
Aperture: 100.00

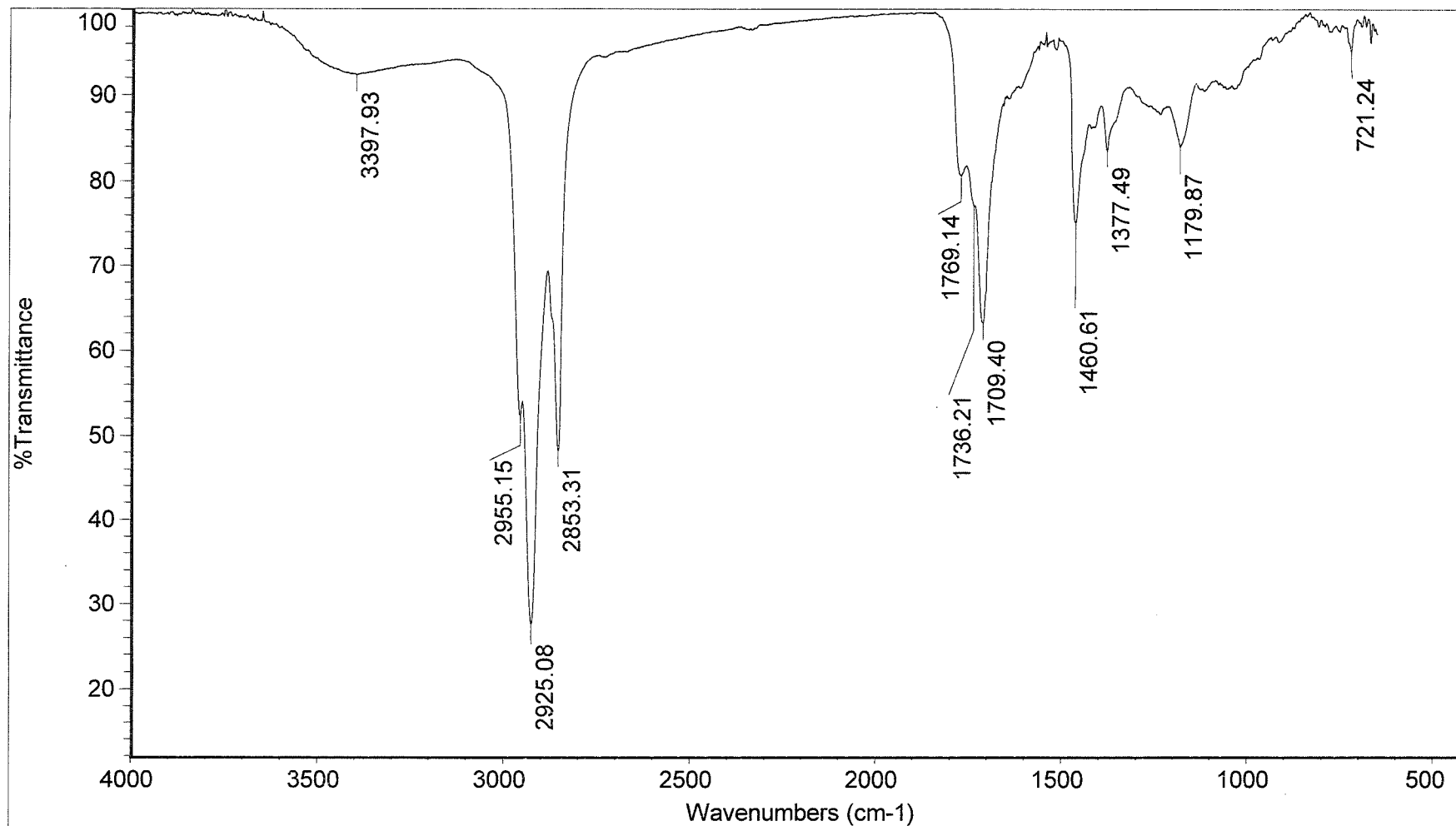

COMMENTS:

18-74457-236968
orange layer (top) + white layer (middle)
PYROLYZATE

FILENAME:

*187445701G

Collection time: Wed Jul 18 17:00:51 2018 (GMT-04:00)

USER NAME:

K. Pinto

EXPERIMENT INFORMATION:

Experiment filename: c:\my documents\omnic\param\mictran.exp
Experiment title: Microscope - Transmission Mode
Experiment accessory: None
Number of sample scans: 64
Number of background scans: 64
Resolution: 4.000
Sample gain: 1.0
Optical velocity: 1.8988
Aperture: 100.00

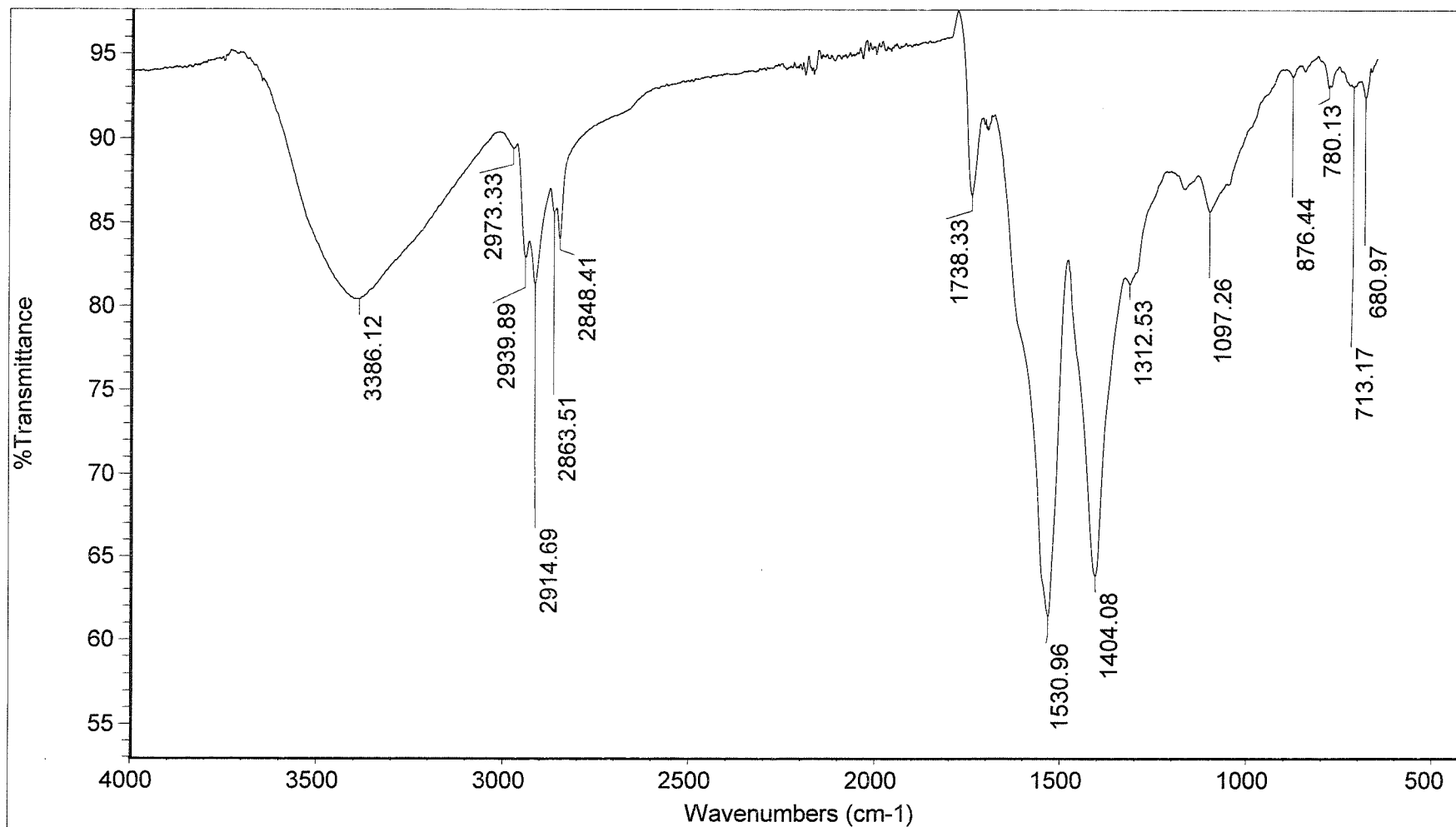

COMMENTS:

18-74457-236968
subtraction result 187445701A - 187445701G
orange (top) - orange/white pyrolyzate

FILENAME:

Subtraction Result:***187445701A
Collection time: Fri Jul 13 11:23:32 2018 (GMT-04:00)

USER NAME:

K. Pinto

EXPERIMENT INFORMATION:

Experiment filename: c:\my documents\omnic\param\OrbitDi.exp
Experiment title: Smart Orbit
Experiment accessory: Smart Orbit
Number of sample scans: 128
Number of background scans: 64
Resolution: 4.000
Sample gain: 8.0
Optical velocity: 0.6329
Aperture: 100.00

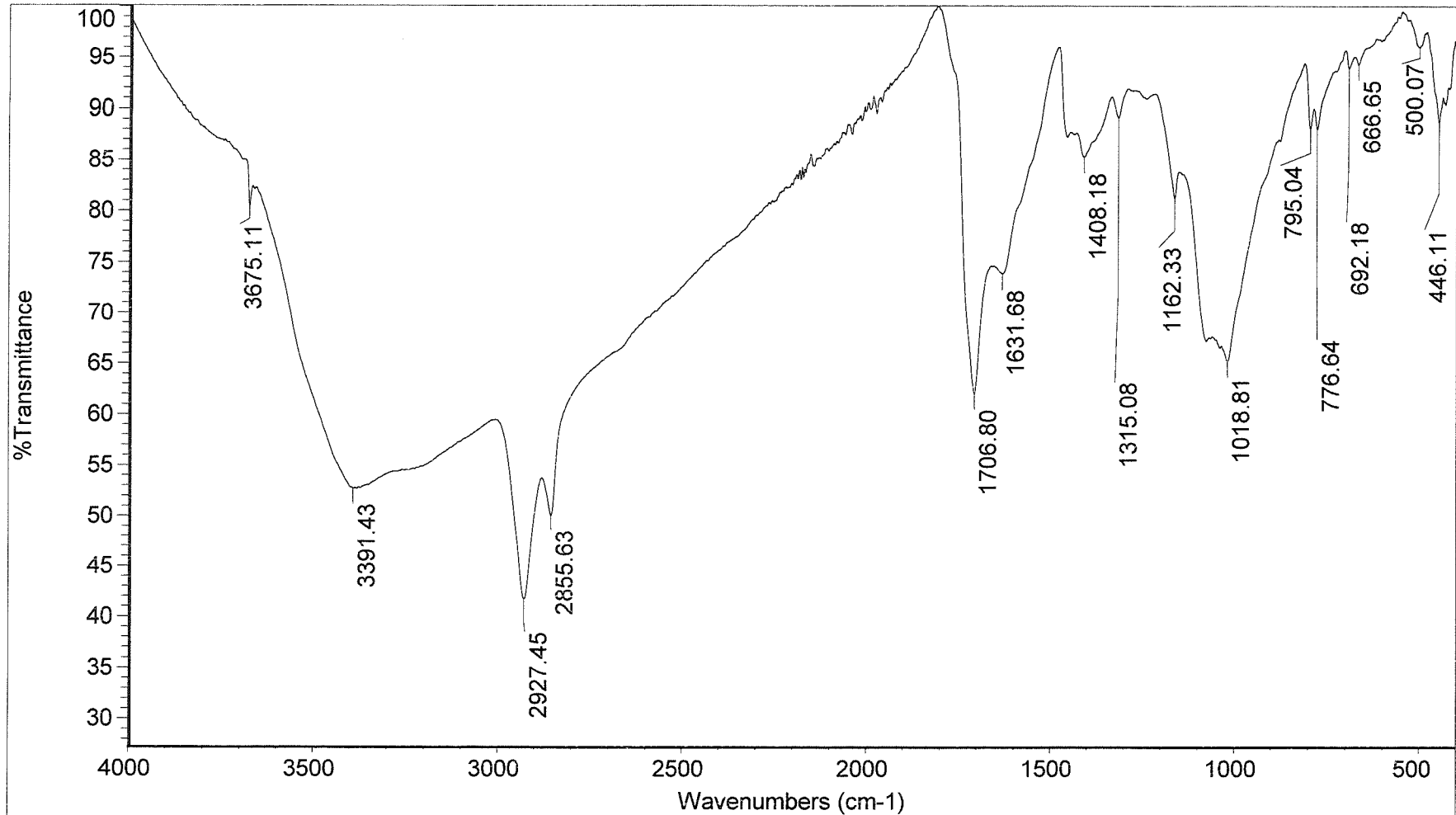

COMMENTS:

18-74457-236968
Old Railway Pedestrian Bridge over
Rideau River - Span #7 Cross Frame
black/dark grey layer (middle)

FILENAME:

***187445701D

USER NAME:

K. Pinto

Collection time: Fri Jul 13 13:03:37 2018 (GMT-04:00)

EXPERIMENT INFORMATION:

Experiment filename: c:\my documents\omnic\param\OrbitDi.exp
Experiment title: Smart Orbit
Experiment accessory: Smart Orbit
Number of sample scans: 128
Number of background scans: 64
Resolution: 4.000
Sample gain: 8.0
Optical velocity: 0.6329
Aperture: 100.00

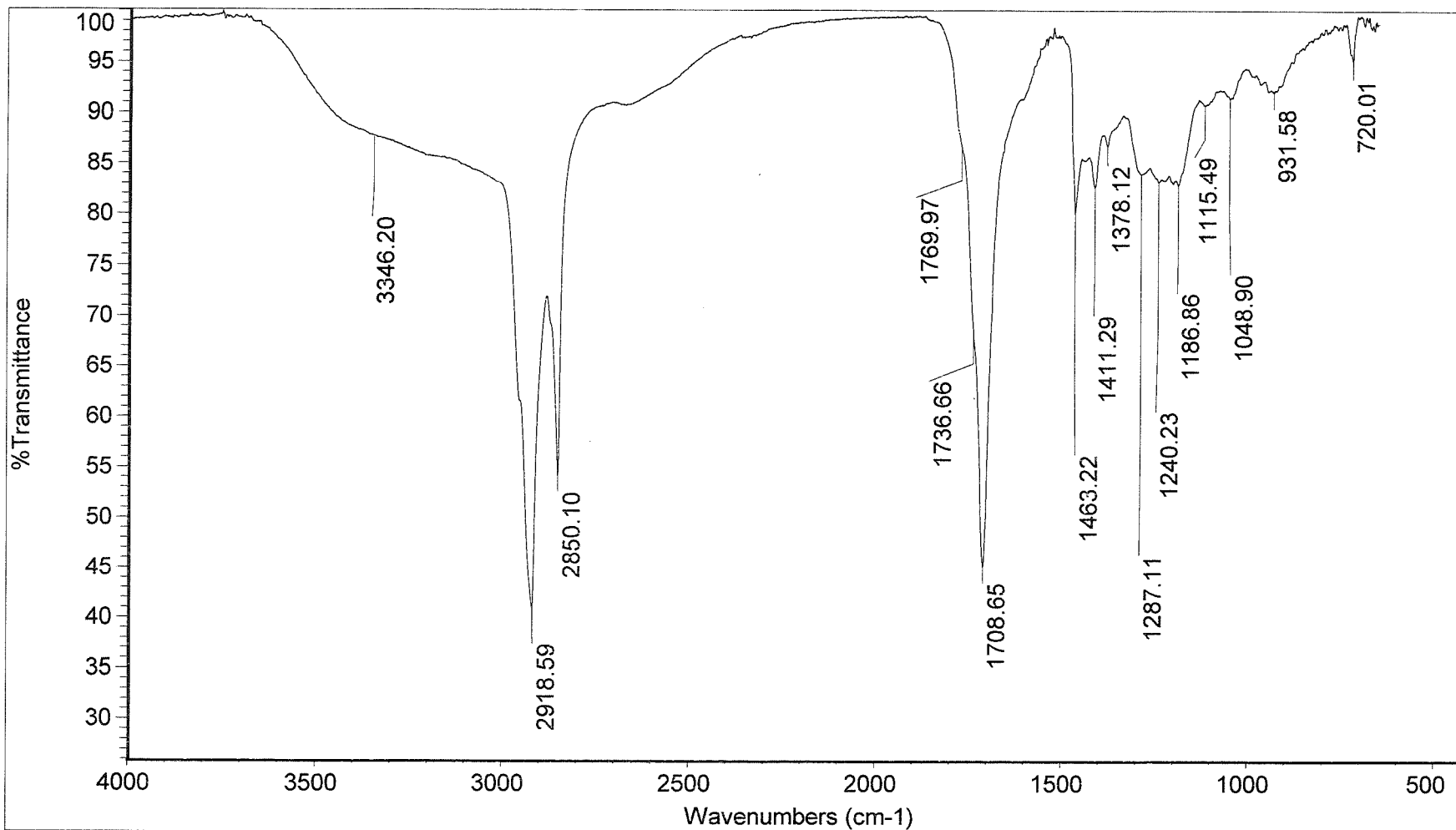

COMMENTS:

18-74457-236968
black/dark grey (middle) layer
PYROLYZATE

FILENAME:

*187445701F

Collection time: Tue Jul 17 17:28:57 2018 (GMT-04:00)

USER NAME:

K. Pinto

EXPERIMENT INFORMATION:

Experiment filename: c:\my documents\omnic\param\mictran.exp
Experiment title: Microscope - Transmission Mode
Experiment accessory: None
Number of sample scans: 64
Number of background scans: 64
Resolution: 4.000
Sample gain: 1.0
Optical velocity: 1.8988
Aperture: 100.00

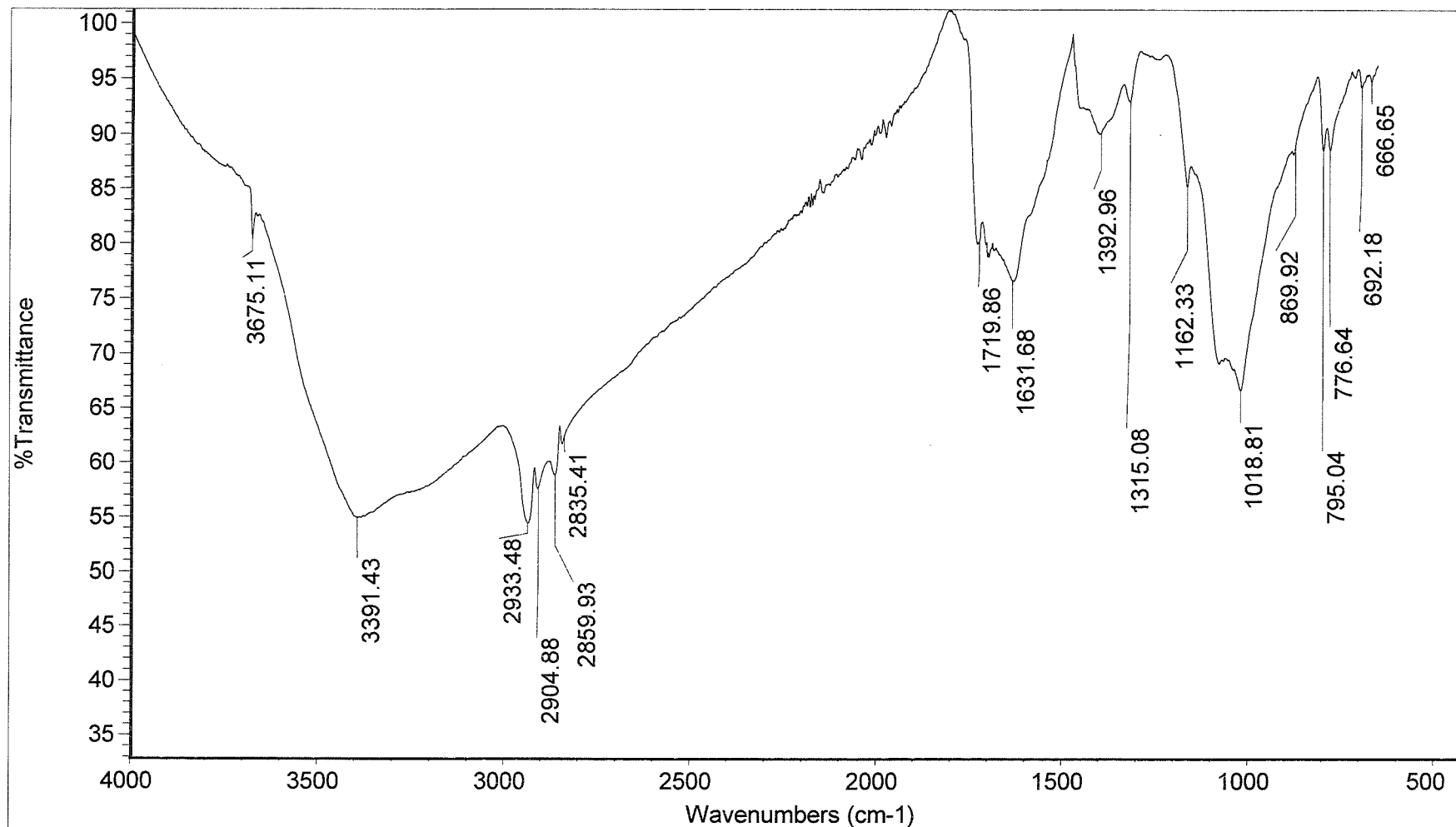

COMMENTS:

18-74457-236968
subtraction result 187445701D - 187445701F
dark grey (middle) - dark grey (middle) pyrolyzate

FILENAME:

Subtraction Result:***187445701D
Collection time: Fri Jul 13 13:03:37 2018 (GMT-04:00)

USER NAME:

K. Pinto

EXPERIMENT INFORMATION:

Experiment filename: c:\my documents\omnic\param\OrbitDi.exp
Experiment title: Smart Orbit
Experiment accessory: Smart Orbit
Number of sample scans: 128
Number of background scans: 64
Resolution: 4.000
Sample gain: 8.0
Optical velocity: 0.6329
Aperture: 100.00

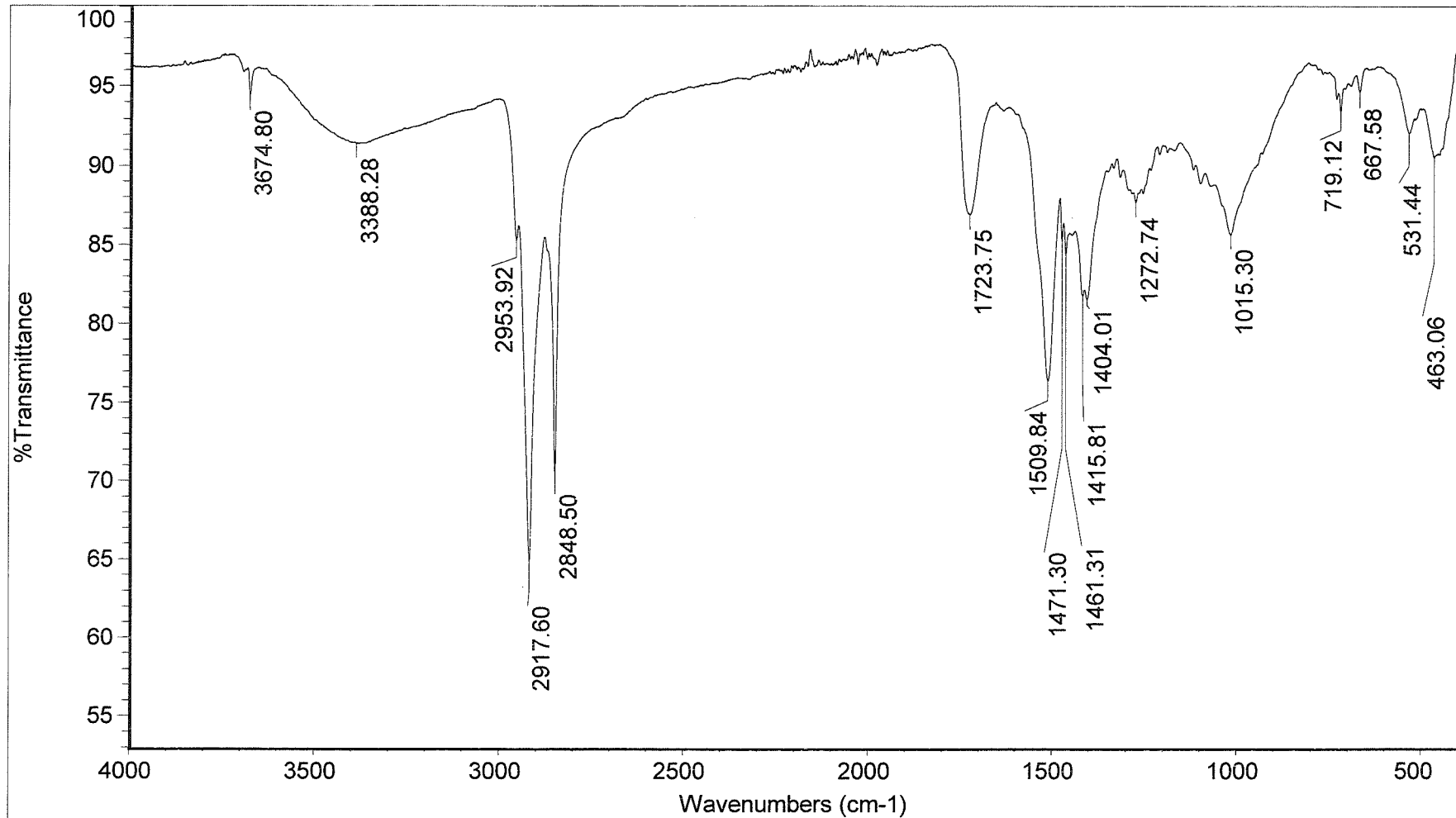

COMMENTS:

18-74457-236968
Old Railway Pedestrian Bridge over
Rideau River - Span #7 Cross Frame
orange layer (middle)

FILENAME:

***187445701E

Collection time: Fri Jul 13 13:18:37 2018 (GMT-04:00)

USER NAME:

K. Pinto

EXPERIMENT INFORMATION:

Experiment filename: c:\my documents\omnic\param\OrbitDi.exp
Experiment title: Smart Orbit
Experiment accessory: Smart Orbit
Number of sample scans: 128
Number of background scans: 64
Resolution: 4.000
Sample gain: 8.0
Optical velocity: 0.6329
Aperture: 100.00

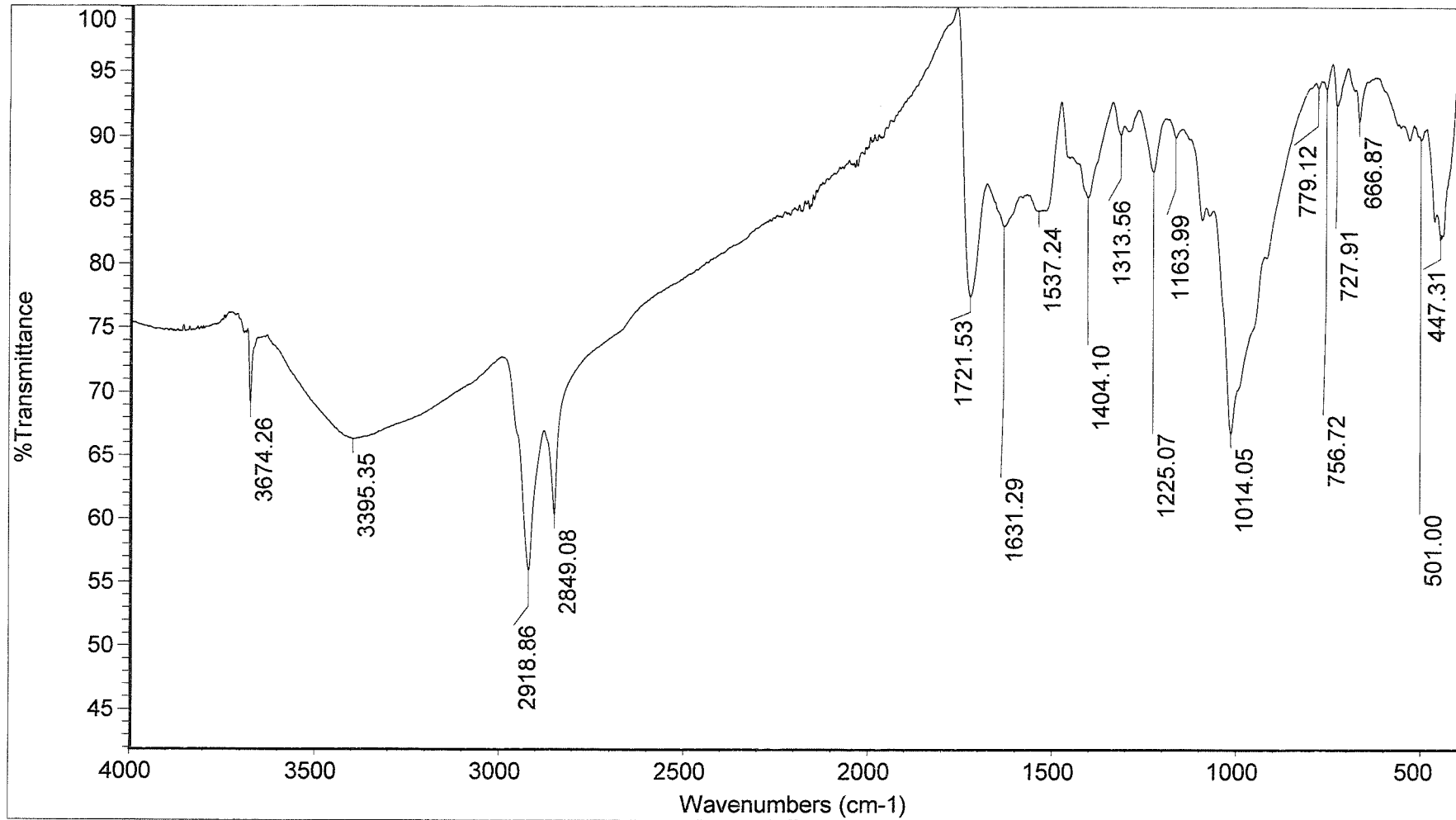

COMMENTS:

18-74457-236968
Old Railway Pedestrian Bridge over
Rideau River - Span #7 Cross Frame
black/dark grey layer (back/bottom)

FILENAME:

***187445701C

Collection time: Fri Jul 13 12:17:27 2018 (GMT-04:00)

USER NAME:

K. Pinto

EXPERIMENT INFORMATION:

Experiment filename: c:\my documents\omnic\param\OrbitDi.exp
Experiment title: Smart Orbit
Experiment accessory: Smart Orbit
Number of sample scans: 128
Number of background scans: 64
Resolution: 4.000
Sample gain: 8.0
Optical velocity: 0.6329
Aperture: 100.00

APPENDIX G

Stakeholder Correspondences

Mergel, Patrick

From: Bennett, Robin <Robin.Bennett@ottawa.ca>
Sent: Tuesday, September 18, 2018 2:43 PM
To: Hortop, Adam; Mergel, Patrick
Cc: Whitehead, Meghan
Subject: RE: Old Railway Rideau River Ped Bridge (SN018600) Renewal Options Analysis - Future Cycling Enhancements and Renewal Opportunities
Attachments: Guidelines for Accommodating Cyclists in Construction Zones - FINAL.doc

Follow Up Flag: Follow up
Flag Status: Flagged

Hi Patrick

I have attached the guidelines – mostly intended for road disruptions but also has some guidance for off-road facilities like MUPs (as this rail bridge would be termed).

Big changes have come and are coming to the cycling network in this part of the city that as Adam notes will definitely increase bicycle traffic in an area that already had reasonably good off-road cycling facilities. The big changes are:

- LRT Pathway from Laurier Avenue to the Industrial/Riverside intersection leading into the Alta Vista district; a completely new direct travel corridor for cyclists to downtown (shifts most bike traffic to east side of OLRT bridge instead of current west side)
- Rideau River Western Pathway to be completed in 2019 between University of Ottawa Lees campus and McIlraith Bridge (new cycling corridor that also didn't exist permits continuous travel between Strathcona Park and McIlraith Bridge - to be extended to Bank Street in future)

People use the rail bridge to go to Industrial/Riverside as well but my experience is that the predominate demand is to Overbrook community via the Rideau River Eastern Pathway that swings under Hwy 417. Still others head towards the Train Station, Max Keeping bridge crossing and 'alphabet streets community' further east.

It is great that you can build the new bridge without any bridge closure of the existing.

Regards
Robin

Robin Bennett, MCIP RPP
Project Manager, Cycling Program/Gestionnaire de projet, Programmes de cyclisme
Transportation Planning/Planification des transports
Transportation Services Department | Service des transports
City of Ottawa/Ville d'Ottawa
EMail: robin.bennett@ottawa.ca
Tel: 613.580.2424.21795

From: Hortop, Adam
Sent: Friday, September 14, 2018 10:39 AM
To: Mergel, Patrick <Patrick.Mergel@parsons.com>; Bennett, Robin <Robin.Bennett@ottawa.ca>
Cc: Whitehead, Meghan <meghan.whitehead@ottawa.ca>

Subject: RE: Old Railway Rideau River Ped Bridge (SN018600) Renewal Options Analysis - Future Cycling Enhancements and Renewal Opportunities

Hi Patrick,

Robin has a document that summarizes the pedestrian and cycling detour guidelines.

If there is structural replacement with a new alignment then I would propose it consider the major desire line for this area. I have drawn in green the most direct alignment for someone on the LRT pathway travelling from the LRT pathway over Riverside Drive to the downtown (attached).

Let me know if this is the kind of guidance that you are seeking.

Robin,

Please share the pedestrian and cycling detour guidelines.

Best regards,
Adam

From: Mergel, Patrick <Patrick.Mergel@parsons.com>

Sent: Thursday, September 13, 2018 9:17 PM

To: Hortop, Adam <Adam.Hortop@ottawa.ca>

Cc: Whitehead, Meghan <meghan.whitehead@ottawa.ca>; Bennett, Robin <Robin.Bennett@ottawa.ca>

Subject: RE: Old Railway Rideau River Ped Bridge (SN018600) Renewal Options Analysis - Future Cycling Enhancements and Renewal Opportunities

Thanks Adam and Meghan for you input and for following up on this.

We will certainly account for these requirements in the renewal study.

Based on our initial review of the scope of work and renewal options considered so far:

- For the major rehabilitation and structure replacement in the same alignment, full closure of the existing bridge to pedestrians and cyclists throughout the duration of construction (likely 2 years) would be required, detouring pedestrians/cyclists via other existing multi-use crossings of Rideau River, including the OLRT Confederation Line Bridge north of Hurdman Station 500m upstream (i.e. west) of the Old Railway Rideau River Pedestrian Bridge and the Adàwe Crossing 1.3 km downstream (i.e. north).
- Structure replacement on a new alignment just upstream (approximately 10m south) of the existing bridge would allow pedestrians and cyclists to continue to use the existing structure without significant disruption until the new bridge is constructed and placed in service, and the existing bridge is then demolished. Approaches would be connected back to existing pathways on either side of the river.

I would appreciate your comments regarding the requirement to detour pedestrians/cyclists due closure of the existing bridge during a major rehabilitation or replacing the structure in the same alignment and whether replacing the structure on a new alignment would be preferred over replacing the structure in the same alignment.

Regards,
Patrick

From: Hortop, Adam <Adam.Hortop@ottawa.ca>

Sent: Thursday, September 13, 2018 12:25 PM

To: Mergel, Patrick <Patrick.Mergel@parsons.com>

Cc: Whitehead, Meghan <meghan.whitehead@ottawa.ca>; Bennett, Robin <Robin.Bennett@ottawa.ca>

Subject: FW: Old Railway Rideau River Ped Bridge (SN018600) Renewal Options Analysis - Future Cycling Enhancements and Renewal Opportunities

Patrick,

We expect that this bridge will see a significant increase in cycling volumes once the LRT pathway opens, providing a direct link to downtown. Further increases are expected as the TOD areas around Lees, Hurdmann and Tremblay are developed. I would echo Zlatko and Jess' comments:

- a. Adding a permanent Bike/Ped counter
- b. Adding lighting (given near-by pathways in the area are receiving lighting)- Your bridge re-hab should anticipate this lighting reaching and crossing this bridge sometime in the coming years (certainly within the lifespan of the re-hab).

and add:

- c. If there is a full replacement, or the rehab allows, provide a clear width of 4 m.
- d. Construct to a standard that facilitates easy winter maintenance of the bridge.

I am available if you would like to discuss.

Best regards,
Adam

From: Whitehead, Meghan

Sent: Tuesday, September 11, 2018 5:35 PM

To: Hortop, Adam <Adam.Hortop@ottawa.ca>

Subject: FW: Old Railway Rideau River Ped Bridge (SN018600) Renewal Options Analysis - Future Cycling Enhancements and Renewal Opportunities

Adam,

This bridge is in Robin's area but surrounded by yours. And Robin is away the rest of this week. Can you please review and provide input to Patrick? See Zlatko and Jess's comments regarding lighting and a counter. Not sure if there are other needs here.

Thanks,

Meghan

From: Mergel, Patrick <Patrick.Mergel@parsons.com>

Sent: Monday, September 10, 2018 9:57 AM

To: Krstulic, Zlatko <Zlatko.Krstulic@ottawa.ca>

Cc: Whitehead, Meghan <meghan.whitehead@ottawa.ca>; Roberts, Samuel <Samuel.Roberts@ottawa.ca>; Lloy, Jessica <Jessica.Lloy@ottawa.ca>

Subject: RE: Old Railway Rideau River Ped Bridge (SN018600) Renewal Options Analysis - Future Cycling Enhancements and Renewal Opportunities

Thanks Zlatko for your input.

For your information, we are considering a major rehabilitation option and a full replacement option (as the original CP Rail bridge was constructed in 1898), therefore we'll account for bridge lighting in either option.

Regards,
Patrick

From: Krstulic, Zlatko <Zlatko.Krstulic@ottawa.ca>
Sent: Monday, September 10, 2018 9:11 AM
To: Mergel, Patrick <Patrick.Mergel@parsons.com>
Cc: Whitehead, Meghan <meghan.whitehead@ottawa.ca>; Roberts, Samuel <Samuel.Roberts@ottawa.ca>; Lloy, Jessica <Jessica.Lloy@ottawa.ca>
Subject: RE: Old Railway Rideau River Ped Bridge (SN018600) Renewal Options Analysis - Future Cycling Enhancements and Renewal Opportunities

Hello Patrick,

I am cc'ing Meghan as she is now looking after the Cycling file as well as Sam who looks after planning for the winter Cycling network.

A couple of things to be considered for the Re-hab scope:

- a. Adding a permanent Bike/Ped counter
- b. Adding lighting (given near-by pathways in the area are receiving lighting)- Your bridge re-hab should anticipate this lighting reaching and crossing this bridge sometime in the coming years (certainly within the lifespan of the re-hab).

Regards,
Zlatko

Zlatko Krstulic, P.Eng.
Innovation Lead,
Digital Service and Innovation Branch,
Service Innovation and Performance Department
City of Ottawa | Tel: 613.580.2424 x 21827

From: Mergel, Patrick <Patrick.Mergel@parsons.com>
Sent: Monday, September 10, 2018 9:02 AM
To: Krstulic, Zlatko <Zlatko.Krstulic@ottawa.ca>; Lloy, Jessica <Jessica.Lloy@ottawa.ca>
Subject: Old Railway Rideau River Ped Bridge (SN018600) Renewal Options Analysis - Future Cycling Enhancements and Renewal Opportunities

Good morning Zlatko/Jessica,

Parsons has been retained by the City of Ottawa to carry out the detailed condition assessment and renewal options analysis for the Old Railway Rideau River Pedestrian Bridge (SN018600), which is located just south of Hwy 417 and east of the University of Ottawa Lees Campus, connecting the NCC's Rideau River Eastern Pathway and the City's Rideau River Western Pathway. See attached geoOttawa map below for location.



It is our understanding from discussions with AMB-Structures (and from information on the geoOttawa site shown as the orange highlighted line) that the bridge and approach pathways are maintained during the winter by the City's Roads Services.

We have been directed to the both of you by the AMB-Structures Project Manager, Kosta Karadakis, to establish future cycling enhancements and renewal opportunities/plans, based on the Community Design Plans (Lees TOD, Old Ottawa East & Hurdman TOD), future land use changes, and any known cycling enhancements near this site.

We would appreciate any comments you both may have to offer at this time regarding this structure. Your comments will be incorporated in our report to the City.

Please don't hesitate to contact me should you have any questions.

Regards,
Patrick

Patrick Mergel, M.Eng., P.Eng., ing.
Senior Structural Engineer/Ingénieur principal en structure
1223 Michael Street North, Suite 100, Ottawa, Ontario, K1J 7T2
Patrick.Mergel@parsons.com P: +1.613.691.1564 / C: +1.613.790.7293

PARSONS - Envision More
www.parsons.com | [LinkedIn \[linkedin.com\]](https://www.linkedin.com) | [Twitter \[twitter.com\]](https://www.twitter.com) | [Facebook \[facebook.com\]](https://www.facebook.com)



NOTICE: This email message and all attachments transmitted with it may contain privileged and confidential information, and information that is protected by, and proprietary to, Parsons Corporation, and is intended solely for the use of the addressee for the specific purpose set forth in this communication. If the reader of this message is not the intended recipient, you are hereby notified that any reading, dissemination, distribution, copying, or other use of this message or its attachments is strictly prohibited, and you should delete this message and all copies and backups thereof. The recipient may not further distribute or use any of the information contained herein without the express written authorization of the sender. If you have received this message in error, or if you have any questions regarding the use of the proprietary information contained therein, please contact the sender of this message immediately, and the sender will provide you with further instructions.

This e-mail originates from the City of Ottawa e-mail system. Any distribution, use or copying of this e-mail or the information it contains by other than the intended recipient(s) is unauthorized. Thank you.

Le présent courriel a été expédié par le système de courriels de la Ville d'Ottawa. Toute distribution, utilisation ou reproduction du courriel ou des renseignements qui s'y trouvent par une personne autre que son destinataire prévu est interdite. Je vous remercie de votre collaboration.

This e-mail originates from the City of Ottawa e-mail system. Any distribution, use or copying of this e-mail or the information it contains by other than the intended recipient(s) is unauthorized. Thank you.

Le présent courriel a été expédié par le système de courriels de la Ville d'Ottawa. Toute distribution, utilisation ou reproduction du courriel ou des renseignements qui s'y trouvent par une personne autre que son destinataire prévu est interdite. Je vous remercie de votre collaboration.

This e-mail originates from the City of Ottawa e-mail system. Any distribution, use or copying of this e-mail or the information it contains by other than the intended recipient(s) is unauthorized. Thank you.

Le présent courriel a été expédié par le système de courriels de la Ville d'Ottawa. Toute distribution, utilisation ou reproduction du courriel ou des renseignements qui s'y trouvent par une personne autre que son destinataire prévu est interdite. Je vous remercie de votre collaboration.

Guidelines for Accommodating Cyclists in Construction Zones and Road Closures

1.0 Guiding Principles

1.1 Bicycles are vehicles

Under the *Highway Traffic Act*, cyclists have the same right to safe passage as motor vehicles (except where bicycles are legally prohibited), and should only be required to dismount and travel as pedestrians where absolutely necessary. Cyclists also are obliged to operate as vehicles, and generally do not require special signage unless [a] dedicated cycling facilities are affected, or [b] specific actions are prescribed (e.g. follow bicycle detour, dismount and walk, caution due to rough surfaces). However, the potential for cyclists to respond differently than motor vehicle operators to certain conditions should be anticipated and considered. For example, cyclists may not readily tolerate delays or restrictions that drivers accept.

1.2 Safety is paramount

Cyclists and pedestrians are vulnerable road users and their needs warrant particular consideration. Adherence to these guidelines will help ensure that road user expectations are consistently met, which in turn will maximize safety.

1.3 Responsibility is shared

Where road closures result from contracted work or special events, the City of Ottawa is responsible for providing advance notification and establishing detours around the work zone. Within construction zones, the contractor is responsible for providing road users with safe passage.

1.4 Limitations on application

The appropriate application of these guidelines may be more or less stringent in a given situation, depending on variables including cyclist volume, development context, season, duration and cost.

2.0 Temporary conditions on roads

Activities that can affect cycling on roads include reconstruction, resurfacing, road cuts or utility work, right-of-way maintenance, encroachments, special events or construction on adjacent land.

2.1 Notification

Unexpected conditions may be more problematic for cyclists than motor vehicle users.

- Provide early notice of projects that could cause significant inconvenience to cyclists (e.g. long detours) using the City's website and newspapers.
- Provide notification signs for all road users in advance of temporary conditions, consistent with general practice. Include distance tabs as appropriate. Ensure that signs do not intrude into the travel path of cyclists or pedestrians; if intrusion is unavoidable, maximize sign visibility.

2.2 Surface conditions

Safe cycling requires a higher standard of travel surface than motor vehicle operation.

- Provide a smooth, hard travel surface at all times. Asphalt is ideal, but a compacted granular surface is acceptable for temporary use if well maintained. Avoid loose gravel, compacted aggregate, sand, mud and standing water. Sweep surfaces regularly, especially the outer 2.0 m of curb lanes.

Mature Neighbourhoods Overlay
Zone sous-jacente du caractère des anciens quartiers

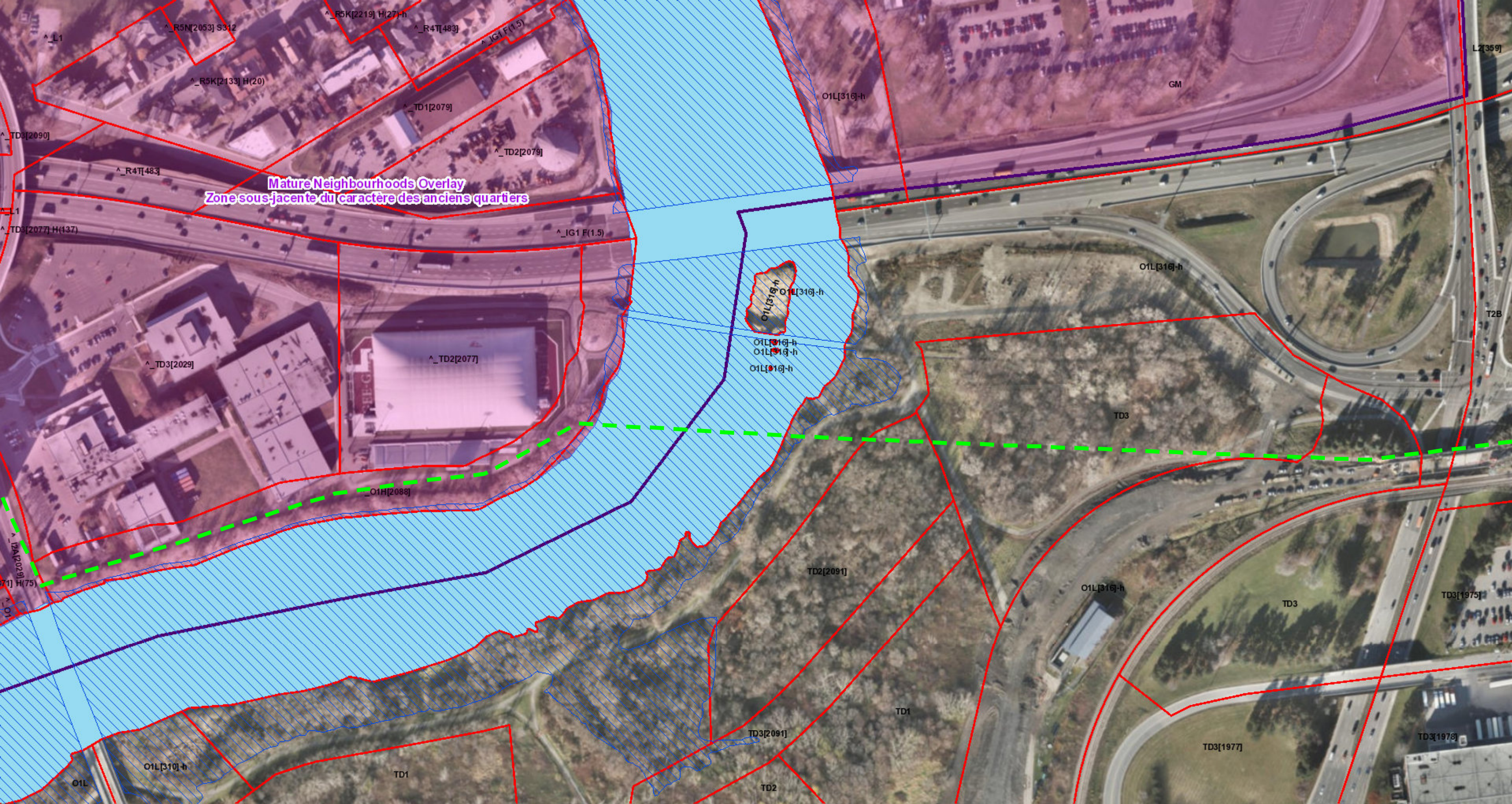

- Ensure that temporary surfaces (e.g. steel plates, timber decking) are skid-resistant with smooth joints at right angles to the travel path.
- Minimize vertical discontinuities. Where cycling volumes are high and discontinuities are unavoidable (e.g. at road cuts, raised ironworks, steel plates that are not recessed into the pavement) consider mitigating them with asphalt ramps. Use reflective paint and barriers (e.g. traffic cones) to direct cyclists away from unramped grade changes.
- Where appropriate, use signs to notify cyclists of any variance from a smooth asphalt condition (e.g. Pavement Ends Sign TC-13, Grooved Pavement Sign TC-47).

If surface conditions cannot be made acceptable:

- Detour cyclists around the work zone (see Section 2.5).*

OR

- Divert cyclists to a pathway or sidewalk (see Section 2.6).*



TC-13



TC-47

2.3 Roads with bike lanes or paved shoulders

Where cyclists approach the work zone in a bike lane or designated paved shoulder it is preferable to maintain those facilities within the work zone, especially if cyclist volumes are high. If required, the alignment of bike lanes or paved shoulders may be diverted within the right of way.

- Provide a minimum bike lane width of 2.0 m (preferred) or 1.2 m (absolute).
- Provide a minimum paved shoulder width of 1.5 m (preferred) or 1.2 m (absolute).
- If motor vehicles are diverted into a bike lane or paved shoulder, notify cyclists that the bike lane or facility ends and shared lane operation begins (Bicycle Lane Closed Sign TC-68; Share the Road Sign WC-47 and Share the Road Tab WC-47S). Apply with distance tabs in advance of lane closure, where appropriate.

If the width of a bike lane or paved shoulder cannot be made acceptable, close the bike lane or paved shoulder to cyclists (Bicycle Lane Closed Sign TC-68) and:

- Divert cyclists into a shared lane (see Section 2.4).*

OR

- Detour cyclists around the work zone (see Section 2.5).*

OR

- Divert cyclists to a pathway or sidewalk (see Section 2.6).*



TC-68



WC-47



WS-47S

2.4 Roads with shared lanes

Where cyclists approach the work zone in a shared curb lane, take care to preserve an acceptable shared lane width through the work zone.

- Where appropriate, notify cyclists of any reduction in shared lane width in the work zone and reaffirm the shared lane condition (Roadway Narrows Sign WA-28; Share the Road Sign WC-47 and Share the Road Tab WC-47S). No other treatment is generally needed if the shared lane width in the work zone is at least 3.75 m (preferred) or 3.5 m (minimum) and operating speeds are 60 km/h or less.
- Consider shared lanes wider than 3.75 m where the concentration of heavy vehicles (trucks or buses) is significant or where operating speeds exceed 60 km/h.
- Where the shared lane is the only travel lane in that direction and its width is less than 3.5 m, or less than 3.75 m with a significant concentration of heavy trucks or buses, consider prohibiting motor vehicles from passing cyclists (Do Not Pass Bicycles Sign RB-33; Do Not Pass Bicycles Tab RB-33S) and posting a reduced speed limit.
- Where the shared lane is one of two or more travel lanes in that direction and its width is less than 3.5 m, or less than 3.75 m with a significant concentration of heavy trucks or buses, consider either posting a sign to instruct motorists to change lanes to pass cyclists, or providing a detour for cyclists.
- Cyclists may need additional lateral clearance when the cycling surface is rough. If so, consider providing a separate bike lane rather than a shared lane through the work zone.

If the width of a shared lane cannot be made acceptable (i.e. very narrow and anticipated high speeds), close the shared lane to cyclists (No Bicycles Sign RB-67) and:

- Detour cyclists around the work zone (see Section 2.5).*

OR

- Divert cyclists to a pathway or sidewalk (see Section 2.6).*



RB-33



RB-67



RB-33S



WA-28

2.5 Cyclist detours around work zone

Detours for all road users do not require special signage for cyclists. However, consider creating bicycle-specific detours if work zone or motor vehicle detour conditions cannot be made acceptable for cycling, or if a potential detour route for cyclists exists that is safer or more convenient than the detour route for motor vehicle users.

- ❑ Provide advance notice of the detour (Bicycle Lane Detour Sign TC-70 with distance tabs).
- ❑ Provide guidance along the detour route (Bicycle Lane Detour markers TC-70 with street name sign for the closed road if desired; Bicycle Detour Ends Sign TC-71).

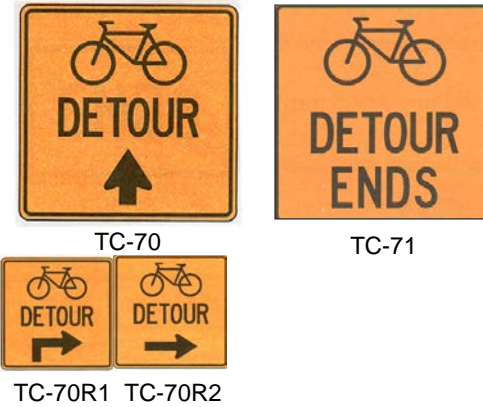

2.6 Diversion of cyclists onto sidewalks

Sections 2.2, 2.3 and 2.4 present situations where it may be appropriate to divert cyclists to sidewalks.

- ❑ In most circumstances, require cyclists diverted to a sidewalk to dismount and travel through the work zone as pedestrians, walking beside their bicycles (Dismount and Walk Sign RB-79; City of Ottawa's Please Walk Your Bike on the Sidewalk sign).
- ❑ In some circumstances, consider allowing cyclists to ride on a sidewalk (Shared Sidewalk Sign RB-93). Contributing factors may include the reduction in cyclist delay compared to dismounting and walking, and the ability to preserve sidewalk safety in view of the sidewalk width and volume of pedestrians and cyclists.
- ❑ Note that sidewalk railings adjacent to hazards (e.g. on bridges) may require modification to achieve a minimum height of 1.5 m.



City of Ottawa's Please Walk Your Bike on the Sidewalk sign

2.7 Traffic control using flags or temporary signals

In work zones where an alternating one-way traffic flow is controlled by flags or temporary signals, cyclists' lower speeds should be considered to enable them to clear the work zone safely.

- Flag controllers should communicate to each other the presence of cyclists in the work zone.
- The timing of temporary signals should take into account the time required for cyclists to travel through the work zone, the available lines of sight, and the existence of potential refuge areas for cyclists in the work zone.

3.0 Temporary conditions on pathways

Activities that can affect cycling on pathways include reconstruction and resurfacing projects, pathway or landscaping maintenance, utility work, encroachments, special events or construction on adjacent land.

3.1 Notification

- Use the City's website and newspapers to provide early notice of projects that could cause significant inconvenience to cyclists.
- Provide notification signs for approaching pathway users at or before key decision points including connections to alternative routes (Construction Ahead Sign TC-1; apply with distance tabs as appropriate; include routing advice as appropriate). For pathways adjacent to roads, shield signs specific to pathway users from the view of road users.
- For long duration pathway closures, install notification signs before the commencement of work to allow time for cyclists to seek alternative routes.



TC-1

3.2 Surface conditions

Safe cycling requires a high standard of travel surface.

- Provide a smooth asphalted or compacted stone dust surface at all times. Avoid loose gravel, compacted aggregate, sand, mud and standing water. Sweep surfaces regularly.
- Ensure that temporary surfaces (e.g. steel plates, timber decking) are skid-resistant with smooth joints at right angles to the travel path.
- Minimize vertical discontinuities. Where they are unavoidable (e.g. at utility cuts) mitigate them using asphalt ramps marked with reflective paint. Use reflective paint and barriers (e.g. traffic cones) to prevent cyclists from encountering unramped grade changes.
- Install appropriate signs to notify cyclists of any variance from a smooth asphalt surface condition (e.g. Grooved Pavement Sign TC-47).

If surface conditions cannot be made acceptable:

- Require cyclists to dismount and walk through the work zone (Dismount and Walk Sign RB-79 or City of Ottawa's Please Walk Your Bike sign)*

OR

- Close the pathway and detour cyclists around the work zone (see Section 3.4)*



City of Ottawa's Please Walk Your Bike sign

3.3 Pathway width reduction

Construction or maintenance activities may require a reduction in the useable width of a pathway.

- Provide a minimum clear pathway width of 1.5 m at all times.
- Install appropriate signs to notify users of a reduced pathway width and encourage caution (Construction Ahead Sign TC-1). Consider requiring cyclists to dismount and walk through longer work zones, where pathway volumes are high, and/or where visibility is poor (Dismount and Walk Sign RB-79 or City of Ottawa's Please Walk Your Bike sign).
- Maintain acceptable surface conditions on the useable portion of the pathway, as discussed in Section 3.2.

3.4 Pathway closure

Activities that could require full closure of a pathway include resurfacing, reconstruction, utility trenching or tree removal.

- Provide notification to pathway users (see Section 3.1).
- Install appropriate barriers to prevent pathway users from entering the work zone (e.g. barricades, chain link fences, snow fences). Consider enclosing the entire work zone to prevent entry by pathway users, particularly during non-work periods.
- Consider providing a detour route along pathways, but do not detour cyclists to roads unless special safety provisions are made (e.g. concrete barriers). Provide advance notice of a detour (Bicycle Lane Detour Sign TC-70 with distance tabs) and guidance along the detour route (Bicycle Lane Detour markers TC-70, TC-70R, TC-70L; Bicycle Detour Ends Sign TC-71).
- For localized short-term closures, consider requiring cyclists to dismount and walk around the work zone on the grass (No Bicycles Sign RB-67, used on the pathway itself; Dismount and Walk Sign RB-79 or City of Ottawa's Please Walk Your Bike sign, both used on the diverted route).
- For localized long-term closures, provide a temporary pathway if alternative cycling routes are not convenient. For temporary pathways, acceptable characteristics include an asphalt or compacted stone dust surface, and a minimum clear width of 3.0 m for two-way travel. Substandard widths may be considered (e.g. in situations with low cyclist volumes, shallow grades and good sightlines) but consider signs to encourage caution (e.g. Shared Sidewalk Sign RB-93 altered to use "Pathway" rather than "Sidewalk"). Substandard depths of asphalt or compacted stone dust may be considered, depending on the expected service life of the temporary pathway. Other substandard characteristics, including rough surfaces or steep grades, may warrant appropriate signs.

Mergel, Patrick

From: Lloy, Jessica <Jessica.Lloy@ottawa.ca>
Sent: Tuesday, September 18, 2018 12:17 PM
To: Mergel, Patrick
Cc: Whitehead, Meghan; Roberts, Samuel; Krstulic, Zlatko
Subject: RE: Old Railway Rideau River Ped Bridge (SN018600) Renewal Options Analysis - Future Cycling Enhancements and Renewal Opportunities

Hi Patrick,

The Multi Urban is what we have on Adawe Bridge. This includes an urban post for pedestrian counting and a zelt counter with ground loops for bike counting. See the link below for a bit more information: [https://www.eco-compteur.com/en/products/multi-range/multi-urban\[eco-compteur.com\]](https://www.eco-compteur.com/en/products/multi-range/multi-urban[eco-compteur.com])

Regards,
Jessica

Jessica Lloy

Pedestrian & Cycling Technologist
Transportation Planning - Transportation Policy and Networks
City of Ottawa
(613) 580 - 2424 ext. 14753
jessica.lloy@ottawa.ca

From: Mergel, Patrick <Patrick.Mergel@parsons.com>
Sent: September-17-18 10:34 AM
To: Lloy, Jessica <Jessica.Lloy@ottawa.ca>
Cc: Whitehead, Meghan <meghan.whitehead@ottawa.ca>; Roberts, Samuel <Samuel.Roberts@ottawa.ca>; Krstulic, Zlatko <Zlatko.Krstulic@ottawa.ca>
Subject: RE: Old Railway Rideau River Ped Bridge (SN018600) Renewal Options Analysis - Future Cycling Enhancements and Renewal Opportunities

Thanks Jessica. Do you have a product name for EcoCounters used on recent pedestrian bridges (e.g. Adawe Crossing)?

Regards,
Patrick

From: Lloy, Jessica <Jessica.Lloy@ottawa.ca>
Sent: Thursday, September 13, 2018 4:09 PM
To: Mergel, Patrick <Patrick.Mergel@parsons.com>; Krstulic, Zlatko <Zlatko.Krstulic@ottawa.ca>
Cc: Whitehead, Meghan <meghan.whitehead@ottawa.ca>; Roberts, Samuel <Samuel.Roberts@ottawa.ca>

Subject: RE: Old Railway Rideau River Ped Bridge (SN018600) Renewal Options Analysis - Future Cycling Enhancements and Renewal Opportunities

Patrick,

Please let me know if you want information or have any questions regarding the EcoCounters.

Kind Regards,

Jessica

Jessica Lloy

Pedestrian & Cycling Technologist

Transportation Planning - Transportation Policy and Networks

City of Ottawa

(613) 580 - 2424 ext. 14753

jessica.lloy@ottawa.ca

From: Mergel, Patrick <Patrick.Mergel@parsons.com>

Sent: September-10-18 9:57 AM

To: Krstulic, Zlatko <Zlatko.Krstulic@ottawa.ca>

Cc: Whitehead, Meghan <meghan.whitehead@ottawa.ca>; Roberts, Samuel <Samuel.Roberts@ottawa.ca>; Lloy, Jessica <Jessica.Lloy@ottawa.ca>

Subject: RE: Old Railway Rideau River Ped Bridge (SN018600) Renewal Options Analysis - Future Cycling Enhancements and Renewal Opportunities

Thanks Zlatko for your input.

For your information, we are considering a major rehabilitation option and a full replacement option (as the original CP Rail bridge was constructed in 1898), therefore we'll account for bridge lighting in either option.

Regards,

Patrick

From: Krstulic, Zlatko <Zlatko.Krstulic@ottawa.ca>

Sent: Monday, September 10, 2018 9:11 AM

To: Mergel, Patrick <Patrick.Mergel@parsons.com>

Cc: Whitehead, Meghan <meghan.whitehead@ottawa.ca>; Roberts, Samuel <Samuel.Roberts@ottawa.ca>; Lloy, Jessica <Jessica.Lloy@ottawa.ca>

Subject: RE: Old Railway Rideau River Ped Bridge (SN018600) Renewal Options Analysis - Future Cycling Enhancements and Renewal Opportunities

Hello Patrick,

I am cc'ing Meghan as she is now looking after the Cycling file as well as Sam who looks after planning for the winter Cycling network.

A couple of things to be considered for the Re-hab scope:

- a. Adding a permanent Bike/Ped counter
- b. Adding lighting (given near-by pathways in the area are receiving lighting)- Your bridge re-hab should anticipate this lighting reaching and crossing this bridge sometime in the coming years (certainly within the lifespan of the re-hab).

Regards,
Zlatko

Zlatko Krstulic, P.Eng.
Innovation Lead,
Digital Service and Innovation Branch,
Service Innovation and Performance Department
City of Ottawa | Tel: 613.580.2424 x 21827

From: Mergel, Patrick <Patrick.Mergel@parsons.com>
Sent: Monday, September 10, 2018 9:02 AM
To: Krstulic, Zlatko <Zlatko.Krstulic@ottawa.ca>; Lloy, Jessica <Jessica.Lloy@ottawa.ca>
Subject: Old Railway Rideau River Ped Bridge (SN018600) Renewal Options Analysis - Future Cycling Enhancements and Renewal Opportunities

Good morning Zlatko/Jessica,

Parsons has been retained by the City of Ottawa to carry out the detailed condition assessment and renewal options analysis for the Old Railway Rideau River Pedestrian Bridge (SN018600), which is located just south of Hwy 417 and east of the University of Ottawa Lees Campus, connecting the NCC's Rideau River Eastern Pathway and the City's Rideau River Western Pathway. See attached geoOttawa map below for location.



It is our understanding from discussions with AMB-Structures (and from information on the geoOttawa site shown as the orange highlighted line) that the bridge and approach pathways are maintained during the winter by the City's Roads Services.

We have been directed to the both of you by the AMB-Structures Project Manager, Kosta Karadakis, to establish future cycling enhancements and renewal opportunities/plans, based on the Community Design Plans (Lees TOD, Old Ottawa East & Hurdman TOD), future land use changes, and any known cycling enhancements near this site.

We would appreciate any comments you both may have to offer at this time regarding this structure. Your comments will be incorporated in our report to the City.

Please don't hesitate to contact me should you have any questions.

Regards,
Patrick

Patrick Mergel, M.Eng., P.Eng., ing.
Senior Structural Engineer/Ingénieur principal en structure
1223 Michael Street North, Suite 100, Ottawa, Ontario, K1J 7T2
Patrick.Mergel@parsons.com P: +1.613.691.1564 / C: +1.613.790.7293

PARSONS - Envision More
www.parsons.com | [LinkedIn \[linkedin.com\]](https://www.linkedin.com) | [Twitter \[twitter.com\]](https://twitter.com) | [Facebook \[facebook.com\]](https://www.facebook.com)



NOTICE: This email message and all attachments transmitted with it may contain privileged and confidential information, and information that is protected by, and proprietary to, Parsons Corporation, and is intended solely for the use of the addressee for the specific purpose set forth in this communication. If the reader of this message is not the intended recipient, you are hereby notified that any reading, dissemination, distribution, copying, or other use of this message or its attachments is strictly prohibited, and you should delete this message and all copies and backups thereof. The recipient may not further distribute or use any of the information contained herein without the express written authorization of the sender. If you have received this message in error, or if you have any questions regarding the use of the proprietary information contained therein, please contact the sender of this message immediately, and the sender will provide you with further instructions.

This e-mail originates from the City of Ottawa e-mail system. Any distribution, use or copying of this e-mail or the information it contains by other than the intended recipient(s) is unauthorized. Thank you.

Le présent courriel a été expédié par le système de courriels de la Ville d'Ottawa. Toute distribution, utilisation ou reproduction du courriel ou des renseignements qui s'y trouvent par une personne autre que son destinataire prévu est interdite. Je vous remercie de votre collaboration.

,

This e-mail originates from the City of Ottawa e-mail system. Any distribution, use or copying of this e-mail or the information it contains by other than the intended recipient(s) is unauthorized. Thank you.

Mergel, Patrick

From: Pinet, Jean-Paul <Jean-Paul.Pinet@ottawa.ca>
Sent: Friday, November 09, 2018 4:54 PM
To: Karadakis, Kosta
Cc: Denyes, Bryden; Mergel, Patrick; Kavanagh, Matt; Gauthier, Claude
Subject: RE: Old Railway Rideau River Ped Bridge (SN018600) Renewal Options Analysis - Operational/Maintenance Issues

Follow Up Flag: Follow up
Flag Status: Completed

Good Afternoon Kosta ,

Our Staff from Industrial Plow up to the Bridge , The Bridge itself is maintained by Hurdman Staff .
Claude Gauthier is the Zone Supervisor

Paul Pinet

*City Of Ottawa
Zone Supervisor
East Roads , 911 Industrial
613- 580-2424 Ext 30850
Cell - 613 -325-9277
Jean-Paul.Pinet@Ottawa.ca*

From: Karadakis, Kosta
Sent: Friday, November 09, 2018 1:35 PM
To: Pinet, Jean-Paul <Jean-Paul.Pinet@ottawa.ca>
Cc: Denyes, Bryden <Bryden.Denyas@ottawa.ca>; Mergel, Patrick <Patrick.Mergel@parsons.com>; Kavanagh, Matt <matt.kavanagh@ottawa.ca>
Subject: RE: Old Railway Rideau River Ped Bridge (SN018600) Renewal Options Analysis - Operational/Maintenance Issues

From: Kavanagh, Matt <matt.kavanagh@ottawa.ca>
Sent: Friday, November 09, 2018 12:31 PM
To: Mergel, Patrick <Patrick.Mergel@parsons.com>; Denyes, Bryden <Bryden.Denyas@ottawa.ca>
Cc: Karadakis, Kosta <kosta.karadakis@ottawa.ca>
Subject: RE: Old Railway Rideau River Ped Bridge (SN018600) Renewal Options Analysis - Operational/Maintenance Issues

Hi Pat. Paul Pinet clears snow from this structure in the winter. He is best to provide comment. I have copied Paul. Have a nice weekend.

Matt

From: Mergel, Patrick <Patrick.Mergel@parsons.com>

Sent: Friday, November 09, 2018 10:58 AM

To: Denyes, Bryden <Bryden.Denyas@ottawa.ca>; Kavanagh, Matt <matt.kavanagh@ottawa.ca>

Cc: Karadakis, Kosta <kosta.karadakis@ottawa.ca>

Subject: RE: Old Railway Rideau River Ped Bridge (SN018600) Renewal Options Analysis - Operational/Maintenance Issues

Hi Bryden/Matt,

I'm just following up on my e-mail below regarding any known maintenance or operational issues with the pedestrian bridge located just south of the Hwy 417 bridge over the Rideau River.

We'd appreciate any comments/input.

Regards,

Patrick

From: Mergel, Patrick

Sent: Monday, September 10, 2018 8:42 AM

To: 'Bryden.Denyas@ottawa.ca' <Bryden.Denyas@ottawa.ca>; 'matt.kavanagh@ottawa.ca' <matt.kavanagh@ottawa.ca>

Subject: Old Railway Rideau River Ped Bridge (SN018600) Renewal Options Analysis - Operational/Maintenance Issues

Hi Bryden/Matt,

Parsons has been retained by the City of Ottawa to carry out the detailed condition assessment and renewal options analysis for the Old Railway Rideau River Pedestrian Bridge (SN018600), which is located just south of Hwy 417 and east of the University of Ottawa Lees Campus, connecting the NCC's Rideau River Eastern Pathway and the City's Rideau River Western Pathway. See attached geoOttawa map below for location.



It is our understanding from discussions with AMB-Structures (and from information on the geoOttawa site shown as the orange highlighted line) that the bridge and approach pathways are maintained during the winter by the City's Road Services. Is there any known operational and/or maintenance issues with the bridge?

We would appreciate any comments you may have to offer at this time regarding this structure. Your comments will be incorporated in our report to the City.

Regards,
Patrick

Patrick Mergel, M.Eng., P.Eng., ing.
Senior Structural Engineer/Ingénieur principal en structure
1223 Michael Street North, Suite 100, Ottawa, Ontario, K1J 7T2
Patrick.Mergel@parsons.com P: +1.613.691.1564 / C: +1.613.790.7293

PARSONS - Envision More
www.parsons.com | [LinkedIn \[linkedin.com\]](https://www.linkedin.com) | [Twitter \[twitter.com\]](https://www.twitter.com) | [Facebook \[facebook.com\]](https://www.facebook.com)



Mergel, Patrick

From: Hal Stimson <hal.stimson@rvca.ca>
Sent: Tuesday, June 26, 2018 9:37 AM
To: Mergel, Patrick
Cc: Sedarous, Mina
Subject: RE: City of Ottawa Old Railway Rideau River Pedestrian Bridge (SN018600) Renewal

Hi Patrick,

Either option will require review and permit from RVCA (and other agencies such as MNRF and DFO).

The in-water timing restriction for the Rideau River is now January 1 to June 30th.

If a new structure is proposed a hydraulic impact assessment will be required.

If in-water scaffolding is required it is expected it would need to be removed by December to avoid freeze up.

If coffer dams are required a P. Eng. design is required with confirmation that they will not impact flooding.

Regards,

Hal Stimson

Inspector,
Rideau Valley Conservation Authority
Box 599, 3889 Rideau Valley Drive
MANOTICK, Ont K4M 1A5
e-mail: hal.stimson@rvca.ca
613-692-3571 ext 1127 1-800-267-3504

From: Mergel, Patrick [mailto:Patrick.Mergel@parsons.com]
Sent: Tuesday, June 19, 2018 9:45 AM
To: Hal Stimson
Cc: Sedarous, Mina
Subject: City of Ottawa Old Railway Rideau River Pedestrian Bridge (SN018600) Renewal

Hi Hal,

Parsons has been retained by the City of Ottawa to carry out the detailed condition assessment and renewal options analysis report for the Old Railway Rideau River Pedestrian, which is located just south of Hwy 417 and east of the University of Ottawa – Lees Campus, connecting the Rideau River Eastern and Western Pathways. See attached map for location.

Built in 1898, this bridge was formerly a CP Rail bridge on the M & O Subdivision supporting single railway track, but has since been re-purposed to carry only pedestrian and cycling traffic. In its current configuration, this 160.1 m long by 4.0 m wide 8-span (19.9 m spans) riveted steel half deck plate girder (HDPG) structure has a laminated timber deck and asphalt wearing surface and is supported on seven (7) in-water reinforced concrete jacketed stone masonry piers and

two (2) reinforced concrete jacketed stone masonry abutments located on the shorelines, all founded directly on bedrock.

At this stage, we continue to evaluate renewal options, but anticipate at least the following options and scope of work in or above the water:

- Option 1 – Major Rehabilitation
 - Structural steel member repairs/replacement
 - Full recoating of at least the underside of deck structural steel members (including a full enclosure as the paint very likely contains lead, with scaffolding placed directly on the riverbed to the structure’s proximity to the water surface and the very shallow depth of the river at this location)
 - Concrete removals and refacing the in-water piers and abutments (including cofferdams and dewatering and possibly temporary rock-filled causeways placed on riverbed)

- Option 2 – Replacement with New Slab-on-Steel Girder Bridge (located directly upstream of existing structure)
 - Removal of the existing steel superstructure
 - Demolition of the existing reinforced concrete jacketed stone masonry in-water piers and abutments on the shorelines, including footings cast directly on bedrock (including cofferdams/dewatering and possibly temporary rock-filled causeways placed on riverbed)
 - Construction of new in-water reinforced concrete piers (3 or 4) directly on the bedrock riverbed (including cofferdams/dewatering and possibly temporary rock-filled causeways placed on riverbed)
 - Construction of new reinforced concrete abutments on the shorelines
 - Installation of new steel girders
 - Construction of new reinforced concrete deck slab

We would appreciate any comments you may have to offer at this time regarding the above-noted proposed bridge renewal options considered with specific interest in permit requirements and in-water works (including timing restrictions). Your comments will be incorporated in our report to the City.

Regards,
Patrick

Patrick Mergel, M.Eng., P.Eng., ing.
Senior Structural Engineer/Ingénieur principal en structure
1223 Michael Street North, Suite 100, Ottawa, Ontario, K1J 7T2
Patrick.Mergel@parsons.com P: +1.613.691.1564 / C: +1.613.790.7293

PARSONS - Envision More
www.parsons.com | [LinkedIn \[linkedin.com\]](https://www.linkedin.com) | [Twitter \[twitter.com\]](https://twitter.com) | [Facebook \[facebook.com\]](https://www.facebook.com)



NOTICE: This email message and all attachments transmitted with it may contain privileged and confidential information, and information that is protected by, and proprietary to, Parsons Corporation, and is intended solely for the use of the addressee for the specific purpose set forth in this communication. If the reader of this message is not the intended recipient, you are hereby notified that any reading, dissemination, distribution, copying, or other use of this message or its attachments is strictly prohibited, and you should delete this message and all copies and backups thereof. The recipient may not further distribute or use any of the information contained herein without the express written authorization of the sender. If you have received this message in error, or if you have any questions regarding the use of the proprietary information contained therein, please contact the sender of this message immediately, and the sender will provide you with further instructions.

Kemptville District

District de Kemptville

10-1 Campus Drive
Kemptville ON K0G 1J0
Tel.: 613 258-8204
Fax: 613 258-3920

10-1, promenade Campus
Kemptville ON K0G 1J0
Tél.: 613 258-8204
Télééc.: 613 258-3920

Mon. Sep 10, 2018

Janna Golzari
Parsons
1223 Michael Street, Suite 100
Ottawa, Ontario
K1J 7T2
(613) 691-1539
janna.golzari@parsons.com

Attention: Janna Golzari

Subject: Information Request - Developments
Project Name: Rideau River Pedestrian Bridge Renewal
Site Address: Rideau River Pedestrian Bridge/Cycling bridge
Our File No. 2018_GLO-5011

Natural Heritage Values

The Ministry of Natural Resources and Forestry (MNRF) Kemptville District has carried out a preliminary review of the above mentioned area in order to identify any potential natural resource and natural heritage values.

The following Natural Heritage values were identified for the general subject area:

- Fish Nursery, Black Crappie Nursery Area
- Fish Nursery, Muskellunge Nursery Area
- Fish Nursery, Rock Bass Nursery Area
- Fish Nursery, Smallmouth Bass Nursery Area
- Fish Nursery, Walleye Nursery Area
- Unevaluated Wetland (Not evaluated per OWES)

Municipal Official Plans contain information related to natural heritage features. Please see the local municipal Official Plan for more information, such as specific policies and direction pertaining to activities which may impact natural heritage features. For planning advice or Official Plan interpretation, please contact the local municipality. Many municipalities require environmental impact studies and other supporting studies be carried out as part of the development application process to allow the municipality to make planning decisions which are consistent with the Provincial Policy Statement (PPS, 2014).

The MNRF strongly encourages all proponents to contact partner agencies and appropriate municipalities early on in the planning process. This provides the proponent with early knowledge regarding agency requirements, authorizations and approval timelines; Ministry of the Environment

and Climate Change (MOECC) and the local Conservation Authority may require approvals and permitting where natural values and natural hazards (e.g., floodplains) exist.

As per the Natural Heritage Reference Manual (NHRM, 2010) the MNRF strongly recommends that an ecological site assessment be carried out to determine the presence of natural heritage features and species at risk and their habitat on site. The MNRF can provide survey methodology for particular species at risk and their habitats.

The NHRM also recommends that cumulative effects of development projects on the integrity of natural heritage features and areas be given due consideration. This includes the evaluation of the past, present and possible future impacts of development in the surrounding area that may occur as a result of demand created by the presently proposed project.

In Addition, the following Fish species were identified: banded killifish, black crappie, johnny darter, mottled sculpin, muskellunge, pumpkinseed, rock bass, slimy sculpin, smallmouth bass, Sunfishes, walleye.

Wildland Fire

MNRF woodland data shows that the site contains woodlands. The lands should be assessed for the risk of wildland fire as per PPS 2014, Section 3.1.8 "*Development shall generally be directed to areas outside of lands that are unsafe for development due to the presence of hazardous forest types for wildland fire. Development may however be permitted in lands with hazardous forest types for wildland fire where the risk is mitigated in accordance with wildland fire assessment and mitigation standards*". Further discussion with the local municipality should be carried out to address how the risks associated with wildland fire will be covered for such a development proposal. Please see the Wildland Fire Risk Assessment and Mitigation Guidebook (2016) for more information.

Significant Woodlands

Section 2.1.5 b) of the PPS states: *Development and site alteration shall not be permitted in significant woodlands unless it has been demonstrated that there will be no negative impacts on the natural features or their ecological functions.* The 2014 PPS directs that significant woodlands must be identified following criteria established by the Ontario Ministry of Natural Resources and Forestry, i.e. the Natural Heritage Reference Manual (NHRM), 2010. Where the local or County Official Plan has not yet updated significant woodland mapping to reflect the 2014 PPS, all wooded areas should be reviewed on a site specific basis for significance. The MNRF Kemptville District modelled locations of significant woodlands in 2011 based on NHRM criteria. The presence of significant woodland on site or within 120 metres should trigger an assessment of the impacts to the feature and its function from the proposed development.

Significant Wildlife Habitat

Section 2.1.5 d) of the PPS states: *Development and site alteration shall not be permitted in significant wildlife habitat unless it has been demonstrated that there will be no negative impacts on the natural features or their ecological functions.* It is the responsibility of the approval authority to identify significant wildlife habitat or require its identification. The MNRF has several guiding documents which may be useful in identification of significant wildlife habitat and characterization of impacts and mitigation options:

- Significant Wildlife Habitat Technical Guide, 2000
- The Natural Heritage Reference Manual, 2010
- Significant Wildlife Habitat Mitigation Support Tool, 2014
- Significant Wildlife Habitat Criteria Schedule for Ecoregion 5E and 6E, 2015

The habitat of special concern species (as identified by the Species at Risk in Ontario list) and Natural Heritage Information Centre tracked species with a conservation status rank of S1, S2 and S3 may be significant wildlife habitat and should be assessed accordingly.

Water

The Ministry of Natural Resources and Forestry (MNR) has established timing window guidelines to restrict in-water work related to an activity during certain periods. These restricted periods are identified in order to protect fish from impacts of works or undertakings in and around water during spawning and other critical life stages. A suite of appropriate measures should be taken for projects involving in-water works to minimize and mitigate impacts to fish, water quality and fish habitat, and include:

- avoiding in-water works during the timing guidelines;
- installation of sediment/erosion control measures;
- avoiding the removal, alteration, or covering of substrates used for fish spawning, feeding, over-wintering or nursery areas; and
- debris control measures to manage falling debris (e.g. spalling).

Timing guidelines are based on species* presence and are therefore subject to change if new information becomes available. Timing guidelines in Kemptville District are:

Waterbody (and applicable geography or Fisheries Management Zone)	Timing Guidelines (no in-water works)
○ St. Lawrence River (FMZ 20)	March 15 – July 15 (Spring spawning species)
○ Ottawa River – Lac Des Chats (FMZ 12)	October 1 to July 15 (Spring and fall spawning species, including Lake Trout and Lake Whitefish)
○ Ottawa River – Lac Deschenes (FMZ 12)	October 15 to July 15 (Spring and fall spawning species, including Cisco)
○ Ottawa River – Lac Dollard des Ormeaux (FMZ 12)	January 1 to July 15 (Winter and spring spawning species, including Burbot)
○ Big Rideau Lake (South Burgess, North Burgess, Bastard and South Elmsley Twps) ○ Charleston Lake (Lansdowne and Escott Twps) ○ Crow Lake (South Crosby Twp)	October 1 to June 30 (Spring and fall spawning species, including Lake Trout)
○ Bass Lake (South Elmsley Twp) ○ Lower Rideau Lake (South Elmsley Twp) ○ Bob’s Lake (South Sherbrooke Twp) ○ Christie Lake (South Sherbrooke Twp) ○ Dalhousie Lake (Dalhousie Twp) ○ Davern Lake (South Sherbrooke Twp) ○ Farren Lake (South Sherbrooke Twp)	October 15 to June 30 (Spring and Fall spawning species, including Lake Whitefish and Cisco)

<ul style="list-style-type: none"> ○ Grippen Lake (Leeds Twp) ○ Indian Lake (South Crosby Twp) ○ Little Long Lake (Lansdowne Twp) ○ Millpond Lake (South Burgess) ○ Otter Lake (South Elmsley, South Burgess and Bastard Twps) ○ Otty Lake (North Burgess and North Elmsley Twps) ○ Pike Lake (North Burgess Twp) ○ Silver Lake (South Sherbrooke Twp) ○ Redhorse Lake (Lansdowne Twp) ○ Tay River (South Sherbrooke, Bathurst, Drummond and North Elmsley Twps) ○ Wolfe Lake (North Crosby Twp) 	
<ul style="list-style-type: none"> ○ Bennett Lake (Bathurst Twp) ○ Crosby Lake (North Crosby Twp) ○ Gananoque River (Leeds Twp) ○ Lac Georges (Plantagenet and Alfred Twps) ○ Gillies Lake (Lanark Twp) ○ Little Crosby Lake (North Crosby Twp) ○ McLaren Lake (North Burgess Twp) ○ Mississippi Lake (Drummond, Beckwith and Ramsay Twps) ○ Mississippi River (Beckwith, Ramsay, Pakenham and Fitzroy Twps) ○ Raisin River below Martintown dam (Charlottenburgh Twp) ○ Rideau River (Wolford, Oxford, Montague, Marlborough, South Gower, North Gower, Osgood, Nepean and Gloucester Twps) ○ South Lake (Leeds Twp) ○ South Nation River below Plantagenet weir (Plantagenet Twp) ○ Upper Rideau Lake (North Crosby Twp) ○ Westport Sand Lake (North Crosby Twp) 	<p style="text-align: center;">January 1 – June 30 (Winter and spring spawning species, including Burbot)</p>
<ul style="list-style-type: none"> ○ Small rivers and streams (denoted on 1:50,000 National Topographic System maps as being one lined) ○ All other waterbodies in FMZ 18 	<p style="text-align: center;">March 15 to June 30 (Spring spawning species)</p>

**Please note: Additional timing restrictions may apply as they relate to endangered and threatened species for works in both water and wetland areas. Timing restrictions are subject to change, depending on species found in a given waterbody.*

In addition to adhering to the above timing guidelines, a work permit from the MNRF may be required depending on the nature and scope of work. No encroachment on the bed or banks of a waterbody/watercourse (e.g. abutments, embankments, etc.) is permitted without MNRF approval. Additional information regarding work permits may be found online at <https://www.ontario.ca/page/crown-land-work-permits#section-2>.

The MNRF does not have any water quality or quantity data available. We recommend that the Ministry of the Environment and Climate Change be contacted for such data along with the local Conservation Authority. For further information regarding fish habitat and protocols, please refer to the following interagency, document, *Fish Habitat Referral Protocol for Ontario* at: http://www.web2.mnr.gov.on.ca/mnr/ebr/fish_hab_referral/protocol_en.pdf.

Additional approvals and permits may be required under the Fisheries Act and the Species at Risk Act; please contact Fisheries and Oceans Canada to determine requirements and next steps. There may also be approvals required by the local Conservation Authority or Transport Canada, and these agencies should be contacted directly to determine requirements. As the MNRF is

responsible for the management of provincial fish populations, we request ongoing involvement in such discussions in order to ensure population conservation.

Species at Risk

A review of the Natural Heritage Information Centre (NHIC) and internal records indicate that there is a potential for the following threatened (THR) and/or endangered (END) species on the site or in proximity to it:

- Bank Swallow (THR)
- Barn Swallow (THR)
- Blanding's Turtle (THR)
- Bobolink (THR)
- Butternut (END)
- Chimney Swift (THR)
- Eastern Meadowlark (THR)
- Eastern Small-footed Myotis (END)
- Little Brown Bat (END)
- Northern Long-eared Bat (END)
- Tri-Colored Bat (END)

All endangered and threatened species receive individual protection under section 9 of the ESA and receive general habitat protection under Section 10 of the ESA, 2007. Thus any potential works should consider disturbance to the individuals as well as their habitat (e.g. nesting sites). General habitat protection applies to all threatened and endangered species. Note some species in Kemptville District receive regulated habitat protection. The habitat of these listed species is protected from damage and destruction and certain activities may require authorization(s) under the ESA. For more on how species at risk and their habitat is protected, please see: <https://www.ontario.ca/page/how-species-risk-are-protected>.

If the proposed activity is known to have an impact on any endangered or threatened species at risk (SAR), or their habitat, an authorization under the ESA may be required. It is recommended that MNRF Kemptville be contacted prior to any activities being carried out to discuss potential survey protocols to follow during the early planning stages of a project, as well as mitigation measures to avoid contravention of the ESA. Where there is potential for species at risk or their habitat on the property, an Information Gathering Form should be submitted to Kemptville MNRF at sar.kemptonville@ontario.ca.

The Information Gathering Form may be found here:

<http://www.forms.ssb.gov.on.ca/mbs/ssb/forms/ssbforms.nsf/FormDetail?OpenForm&ACT=RDR&TAB=PROFILE&ENV=WWE&NO=018-0180E>

For more information on the ESA authorization process, please see:

<https://www.ontario.ca/page/how-get-endangered-species-act-permit-or-authorization>

One or more special concern species has been documented to occur either on the site or nearby. Species listed as special concern are not protected under the ESA, 2007. However, please note that some of these species may be protected under the Fish and Wildlife Conservation Act and/or

Migratory Birds Convention Act. Again, the habitat of special concern species may be significant wildlife habitat and should be assessed accordingly. Species of special concern for consideration:

- Eastern Wood-Pewee (SC)
- Peregrine Falcon (SC)
- Snapping Turtle (SC)
- Wood Thrush (SC)
- Monarch (SC)
- Northern Map Turtle (SC)

If any of these or any other species at risk are discovered throughout the course of the work, and/or should any species at risk or their habitat be potentially impacted by on site activities, MNRF should be contacted and operations be modified to avoid any negative impacts to species at risk or their habitat until further direction is provided by MNRF.

Please note that information regarding species at risk is based largely on documented occurrences and does not necessarily include an interpretation of potential habitat within or in proximity to the site in question. Although this data represents the MNRF's best current available information, it is important to note that a lack of information for a site does not mean that additional features and values are not present. It is the responsibility of the proponent to ensure that species at risk are not killed, harmed, or harassed, and that their habitat is not damaged or destroyed through the activities carried out on the site.

The MNRF continues to strongly encourage ecological site assessments to determine the potential for SAR habitat and occurrences. When a SAR or potential habitat for a SAR does occur on a site, it is recommended that the proponent contact the MNRF for technical advice and to discuss what activities can occur without contravention of the Act. For specific questions regarding the Endangered Species Act (2007) or SAR, please contact MNRF Kemptville District at sar.kemptville@ontario.ca.

The approvals processes for a number of activities that have the potential to impact SAR or their habitat have recently changed. For information regarding regulatory exemptions and associated online registration of certain activities, please refer to the following website: <https://www.ontario.ca/page/how-get-endangered-species-act-permit-or-authorization>.

Please note: The advice in this letter may become invalid if:

- The Committee on the Status of Species at Risk in Ontario (COSSARO) re-assesses the status of the above-named species OR adds a species to the SARO List such that the section 9 and/or 10 protection provisions apply to those species; or
- Additional occurrences of species are discovered on or in proximity to the site.

This letter is valid until: Tue. Sep 10, 2019

The MNRF would like to request that we continue to be circulated on information with regards to this project. If you have any questions or require clarification please do not hesitate to contact me.

Sincerely,

Carolyn Hann
Management Biologist
carolyn.hann@ontario.ca

Encl.\n-ESA Infosheet\n-NHIC/LIO Infosheet

Natural. Valued. Protected.

Natural Heritage Information Centre

Land Information Ontario

Natural Heritage Information Centre: <http://nhic.mnr.gov.on.ca/>

Biodiversity Explorer (mapping): <https://www.biodiversityexplorer.mnr.gov.on.ca/nhicWEB/main.jsp>

Land Information Ontario: <http://www.mnr.gov.on.ca/en/Business/LIO/index.html>

Ontario Geospatial Data Exchange: http://www.mnr.gov.on.ca/en/Business/LIO/2ColumnSubPage/STEL02_167959.html

LIO Make-a-Map: http://www.mnr.gov.on.ca/en/Business/LIO/2ColumnSubPage/STDPROD_068999.html

Ontario Maps: http://www.mnr.gov.on.ca/en/Business/LIO/2ColumnSubPage/STDPROD_068512.html

The **Natural Heritage Information Centre** (NHIC) compiles, maintains and distributes information on natural species, plant communities and spaces of conservation concern in Ontario. This information is stored in a spatial database used for tracking this information. The Centre also has a library with conservation-related literature, reports, books, and maps, which are accessible for conservation applications, land use planning, and natural resource management. The NHIC website makes much of this information available through the internet.

Natural Heritage Information Centre

300 Water Street, 2nd Floor, North Tower
P.O. Box 7000, Peterborough, ON, K9J 8M5
Tel.:(705) 755-2159 Fax:(705) 755-2168

Land Information Ontario (LIO) manages key provincial datasets. LIO makes these and hundreds of other data sets available to registered users at no charge. LIO also coordinates public and private sector organizations to collect high resolution satellite imagery for Ontario providing significant cost savings for all partners. Technical bulletins, newsletters and more are available online. More details regarding Ontario imagery and data can be searched, ordered and accessed online.

LIO's Ontario Geospatial Data Exchange (OGDE) allows more than 400 public sector organizations to easily share and use digital geographic information under a single legal agreement. Membership is available to eligible public organizations at no costs.

Through the website, Maps & Map Tools are made available, including online mapping software: LIO Make-a-Map.

Land Information Ontario

lio@ontario.ca

LIO Support Team: (705) 755-1878

Or for specifics, see online at:

http://www.mnr.gov.on.ca/en/Business/LIO/2ColumnSubPage/STDPROD_068510.html

Additional Information pertaining to NHIC, LIO and other Natural Heritage and Data and Information tools is available in the **MNR Kemptville Information Request Guide (2012)**.

Natural. Valued. Protected.

Endangered Species Act, 2007 & Species At Risk in Ontario

Background

Endangered Species Act: http://www.e-laws.gov.on.ca/html/statutes/english/elaws_statutes-07e06_e.htm

Species at Risk in Ontario List: www.mnr.gov.on.ca/en/Business/Species/2ColumnSubPage/246809.html

The Endangered Species Act (ESA) 2007 protects both species and habitat. Section 9 of the ESA “prohibits killing, harming, harassing, capturing, possessing, collecting, buying, selling, trading, leasing or transporting species that are listed as threatened, endangered or extirpated”. Section 10 of the ESA, 2007 prohibits damaging or destroying habitat of endangered or threatened species. Protected habitat is either based on general definition in the Act or prescribed through a regulation. The ESA 2007 defines general habitat as an area on which the species depends, directly or indirectly, to carry on its life processes, including reproduction, rearing, hibernation, migration or feeding.

It is important to be aware that changes may occur in both species and habitat protection. The ESA applies to listed species on the Species at Risk in Ontario List (SARO). The Committee on the Status of Species in Ontario (COSSARO) meets regularly to evaluate species for listing and/or re-evaluate species already listed. As a result, species’ designations may change that could in turn change the level of protection they receive under the ESA 2007. Also, habitat protection provisions for a species may change e.g. if a species-specific habitat regulation comes into effect. The regulation would establish the area that is protected as habitat for the species.

Information with respect to SAR can be found in the online database at the Natural Heritage Information Centre (NHIC) - <http://nhic.mnr.gov.on.ca/nhic.cfm> . The NHIC compiles, maintains and distributes information on species at risk and updates its information on a regular basis. We encourage you to routinely check the NHIC database to obtain the most up to date SAR information for proposed work locations. However, while the NHIC database is the best available source of data, even when there are no known occurrences documented at a site, there is a possibility that SAR may occur at a proposed work location.

All data represents the MNR’s best current available information, it is important to note that a lack of occurrence at a site does not mean that there are no Species at Risk (SAR) at the location. The MNR continues to encourage ecological site assessments to determine the potential for other SAR occurrences. When a SAR does occur on a proposed site, it is recommended that the proponent contact the MNR for technical advice and to discuss what activities can occur without contravention of the Act. If an activity is proposed that will contravene the Act (such as Section 9 or 10), the proponent must contact the MNR to discuss the potential for application of certain permits (Section 17) or agreement (Regulation 242/08). For specific questions regarding the Endangered Species Act (2007) or species at risk, please contact a district Species at Risk Biologist at sar.kemptville@ontario.ca.

APPENDIX H

Financial Analysis Data and DCA Forms



Old Railway Rideau River Pedestrian Bridge (SN018600)

Class 'C' Construction Cost Estimate - Option 1: Major Rehabilitation in 2023

Item No.	Item Description	Unit	Quantity	Unit Rate	Total Cost
1	Mobilization/Demobilization	LS	1	\$175,000	\$175,000
2	Field Office for Contract Administrator	wk	104	\$500	\$52,000
3	Traffic Control	LS	1	\$75,000	\$75,000
4	Construction Site Pedestrian Control (including Cyclists)	LS	1	\$50,000	\$50,000
5	Contractor Staging and Storage Areas	LS	1	\$100,000	\$100,000
6	Erosion & Sediment Control	LS	1	\$100,000	\$100,000
7	Turtle Fencing (including Installation, Monitoring and Removal)	m	100	\$200	\$20,000
8	Marine Traffic Control Measures	LS	1	\$10,000	\$10,000
9	Temporary In-Water Access to Work Area (Rip-Rap Stone Causeways)	LS	1	\$400,000	\$400,000
10	Protection Systems (Cofferdams, including Dewatering)	LS	1	\$900,000	\$900,000
11	Access to Work Area, Scaffolding, and Work Platforms (incl. Enviro. Protection)	LS	1	\$1,500,000	\$1,500,000
12	Remove Timber Bridge Deck System and Asphalt Wearing Surface	LS	1	\$200,000	\$200,000
13	Install New Timber Bridge Deck System	LS	1	\$700,000	\$700,000
14	Replace Lateral Bracing (incl. gusset plates)	ea	96	\$3,000	\$288,000
15	Replace Cross Frames	ea	56	\$5,000	\$280,000
16	Replace Shelf Angles	ea	96	\$2,000	\$192,000
17	Replace Vertical Stiffeners	ea	40	\$1,000	\$40,000
18	Replace Localized Rivets with High Strength Bolts	ea	1200	\$100	\$120,000
19	Coating Existing Structural Steel and Railing Systems	LS	1	\$500,000	\$500,000
20	Disposal of Spent Material as Hazardous Waste (Provisional)	LS	1	\$50,000	\$50,000
21	Coating New Structural Steel	LS	1	\$100,000	\$100,000
22	Jacking All Spans and Temporary Support	LS	1	\$320,000	\$320,000
23	Replace Bridge Bearings	ea	32	\$3,500	\$112,000
24	Concrete Removal - Partial Depth (including abutment walls, bearing seats, wingwalls, ballast walls and pier shafts)	m ²	700	\$800	\$560,000
25	Concrete Refacing (including abutment walls, bearing seats, wingwalls, ballast walls and pier shafts)	m ²	700	\$1,200	\$840,000
26	Replace Railings on Wingwalls	m	20	\$500	\$10,000
27	Rock Protection on East Embankment	m ³	70	\$300	\$21,000
28	Approach Pathway Modifications	LS	1	\$200,000	\$200,000
29	Bridge and Approach Pathway Lighting	LS	1	\$150,000	\$150,000
30	Landscaping	LS	1	\$100,000	\$100,000
Sub-Total					\$8,165,000
Contingency (25%)					\$2,041,250
Engineering (20%)					\$1,633,000
Total Estimated Cost					\$11,840,000

Notes:

1. Cost estimate does not include 13% HST
2. Cost estimate includes engineering services during construction and construction administration services
3. Cost estimate does not include any SAR mitigation measures for bird netting on structure
4. TOTAL ESTIMATED COSTS are rounded up to the nearest \$1000
5. Costs are in 2018 dollars



Old Railway Rideau River Pedestrian Bridge (SN018600)

Class 'C' Construction Cost Estimate - Option 2: Structure Replacement on New Alignment in 2023

Item No.	Item Description	Unit	Quantity	Unit Rate	Total Cost
1	Mobilization/Demobilization	LS	1	\$150,000	\$150,000
2	Field Office for Contract Administrator	wk	104	\$500	\$52,000
3	Traffic Control	LS	1	\$50,000	\$50,000
4	Construction Site Pedestrian Control (including Cyclists)	LS	1	\$50,000	\$50,000
5	Contractor Staging and Storage Areas	LS	1	\$100,000	\$100,000
6	Erosion & Sediment Control	LS	1	\$75,000	\$75,000
7	Turtle Fencing (including Installation, Monitoring and Removal)	m	200	\$200	\$40,000
8	Marine Traffic Control Measures	LS	1	\$10,000	\$10,000
9	Temporary In-Water Access to Work Area (Rip-Rap Stone Causeways)	LS	1	\$400,000	\$400,000
10	Protection Systems (Cofferdams, including Dewatering)	LS	1	\$500,000	\$500,000
11	Removal of Existing Bridge (incl. ESC, Cofferdams, Dewatering)	LS	1	\$900,000	\$900,000
12	Earth Excavation for Structure	m ³	1000	\$75	\$75,000
13	Rock Excavation for Structure	m ³	100	\$500	\$50,000
14	Granular 'B' Type II Backfill to Structure	t	500	\$100	\$50,000
15	Concrete Footings	m ³	100	\$900	\$90,000
16	Concrete Substructure (Abutments and Piers)	m ³	250	\$2,000	\$500,000
17	Concrete Deck	m ³	200	\$3,500	\$700,000
18	Concrete Approach Slabs	m ³	12	\$1,500	\$18,000
19	Fabrication, Delivery and Erection of Structural Steel	LS	1	\$1,000,000	\$1,000,000
20	Bearings	ea	10	\$3,000	\$30,000
21	Stainless Steel Bridge Railings	m	340	\$1,500	\$510,000
22	Approach Pathways (including Embankments)	LS	1	\$1,000,000	\$1,000,000
23	Bridge and Approach Pathway Lighting	LS	1	\$200,000	\$200,000
24	Landscaping	LS	1	\$250,000	\$250,000
Sub-Total					\$6,800,000
Contingency (25%)					\$1,700,000
Engineering (20%)					\$1,360,000
Total Estimated Cost					\$9,860,000

Notes:

1. Cost estimate does not include 13% HST
2. Cost estimate includes engineering services during construction and construction administration services
3. Cost estimate does not include any SAR mitigation measures for bird netting on structure
4. TOTAL ESTIMATED COSTS are rounded up to the nearest \$1000
5. Costs are in 2018 dollars

Class 'C' Construction Cost Estimates - Life Cycle Cost Breakdown for Various Treatments

Treatment 1: Replace Expansion Joint Seals (Abutments Only)					
Item No.	Item Description	Unit	Quantity	Unit Rate	Total Cost
1	Mobilization and Demobilization	LS	1	\$1,000	\$1,000
2	Traffic Control (Pedestrians and Cyclists)	LS	1	\$3,000	\$3,000
3	Replace Expansion Joint Seals (Abutments Only)	m	9	\$500	\$4,500
Sub-Total					\$8,500
Contingency (25%)					\$2,125
Engineering (20%)					\$1,700
Total Estimated Cost					\$13,000

Treatment 2: Mill & Pave and Replace Expansion Joint Seals (Abutments and Piers)					
Item No.	Item Description	Unit	Quantity	Unit Rate	Total Cost
1	Mobilization and Demobilization	LS	1	\$2,500	\$2,500
2	Traffic Control (Pedestrians and Cyclists)	LS	1	\$5,000	\$5,000
3	Partial Depth Asphalt Removal on Deck and Approaches	m ²	690	\$20	\$13,800
4	Performance Graded Superpave	t	70	\$300	\$21,000
5	Replace Expansion Joint Seals (Abutments and Piers)	m	36	\$500	\$18,000
Sub-Total					\$60,300
Contingency (25%)					\$15,075
Engineering (20%)					\$12,060
Total Estimated Cost					\$88,000

Treatment 3: Replace Expansion Joint Assemblies (Abutments Only) and Concrete Repairs					
Item No.	Item Description	Unit	Quantity	Unit Rate	Total Cost
1	Mobilization and Demobilization	LS	1	\$5,000	\$5,000
2	Traffic Control (Pedestrians and Cyclists)	LS	1	\$15,000	\$15,000
3	Access to Work Areas	LS	1	\$25,000	\$25,000
4	Concrete Patch Repairs (Deck, Abutments and Piers)	m ²	10	\$2,500	\$25,000
5	Replace Expansion Joint Assemblies (Abutments Only)	m	9	\$4,500	\$40,500
Sub-Total					\$110,500
Contingency (25%)					\$27,625
Engineering (20%)					\$22,100
Total Estimated Cost					\$161,000

Treatment 4: Replace Bearings, Replace Expansion Joint Seals (Abutments Only) and Concrete Repairs					
Item No.	Item Description	Unit	Quantity	Unit Rate	Total Cost
1	Mobilization and Demobilization	LS	1	\$10,000	\$10,000
2	Traffic Control (Pedestrians and Cyclists)	LS	1	\$15,000	\$15,000
3	Access to Work Areas (including Environmental Protection)	LS	1	\$50,000	\$50,000
4	Concrete Patch Repairs (Deck, Abutments and Piers)	m ²	10	\$2,500	\$25,000
5	Jacking Entire Structure and Temporary Support	LS	1	\$75,000	\$75,000
6	Replace Bearings (Abutments and Piers)	ea	10	\$3,000	\$30,000
7	Replace Expansion Joint Seals (Abutments Only)	m	9	\$500	\$4,500
Sub-Total					\$209,500
Contingency (25%)					\$52,375
Engineering (20%)					\$41,900
Total Estimated Cost					\$304,000

Treatment 5: Replace Expansion Joint Seals (Abutments Only) and Concrete Repairs					
Item No.	Item Description	Unit	Quantity	Unit Rate	Total Cost
1	Mobilization and Demobilization	LS	1	\$5,000	\$5,000
2	Traffic Control (Pedestrians and Cyclists)	LS	1	\$10,000	\$10,000
3	Access to Work Areas	LS	1	\$25,000	\$25,000
4	Concrete Patch Repairs (Deck, Abutments and Piers)	m ²	10	\$2,500	\$25,000
5	Replace Expansion Joint Seals (Abutments Only)	m	9	\$500	\$4,500
Sub-Total					\$69,500
Contingency (25%)					\$17,375
Engineering (20%)					\$13,900
Total Estimated Cost					\$101,000

Input 1 - GENERAL

Name of Structure:	Old Railway Rideau River Pedestrian Bridge
Site Number:	SN018600 (start with ')
Number of Options Considered:	2 (max. 4)
Discount Rate:	0.03 (0.06 recommended in MTO Financial Analysis Manual)
Number of Rows to be entered:	(not used for level 1 and 2)
Time period:	75 (normally 50 years)
Model Description:	Level 2 Life Cycle Cost Analysis

Input 2 - COST ESTIMATE FOR EACH TREATMENT

Item Description	Rehabilitation	Replacement	Treatment 1	Treatment 2	Treatment 3	Treatment 4	Treatment 5	
	Major Rehabilitation	Structure Replacement on New Alignment	Replace Joint Seals (Abutments)	Mill & Pave and Replace Joint Seals (Abutments & Piers)	Replace Joints (Abutments) and Concrete Repairs	Replace Bearings, Joint Seals (Abutments) and Concrete Repairs	Replace Joint Seals (Abutments) and Concrete Repairs	
Design								
Construction	\$11,840,000.00	\$ 9,860,000.00	\$ 13,000.00	\$ 88,000.00	\$ 161,000.00	\$ 304,000.00	\$ 101,000.00	
Demolition								
Right-of-Way								
Approaches								
Utilities								
Creek Diversion								
Detour								
Other								
Total	\$11,840,000.00	\$ 9,860,000.00	\$ 13,000.00	\$ 88,000.00	\$ 161,000.00	\$ 304,000.00	\$ 101,000.00	\$ -

Input 3 - COST DATA FOR EACH OPTION

Analysis Year	Option 1 Description	Cost in Current Dollars	Option 2 Description	Cost in Current Dollars
5	Rehabilitation	\$ 11,840,000	Replacement	\$ 9,860,000
20	Treatment 2	\$ 88,000	Treatment 1	\$ 13,000
30	Replacement	\$ 9,860,000		\$ -
35		\$ -	Treatment 3	\$ 161,000
45	Treatment 1	\$ 13,000		\$ -
55		\$ -	Treatment 4	\$ 304,000
60	Treatment 3	\$ 161,000		\$ -
70		\$ -	Treatment 3	\$ 161,000
75	Treatment 5	\$ 101,000		\$ -
Totals		\$22,063,000		\$10,499,000

Input 4 - SECOND CYCLE REPLACEMENT TO DETERMINE RESIDUAL VALUE

Option	Replacement Year	Cost
1	105	
2	80	

Residual Value Calculation Table

Option	Replacement year	Cost	Residual Year	Value at end of 1st cycle	Residual value at end of 1st cycle	Residual value at year zero
1	105	\$ 13,000.00	30	\$ 5,355.83	\$ 7,644.17	-\$ 832.80
2	80	\$ 13,000.00	5	\$ 11,213.91	\$ 1,786.09	-\$ 194.59

Output

Year	Option 1		Option 2	
	Cost	Present Value	Cost	Present Value
5	\$11,840,000.00	\$10,213,288.01	\$ 9,860,000.00	\$ 8,505,322.61
20	\$ 88,000.00	\$ 48,723.47	\$ 13,000.00	\$ 7,197.78
30	\$ 9,860,000.00	\$ 4,062,189.45	\$ -	\$ -
35	\$ -	\$ -	\$ 161,000.00	\$ 57,216.73
45	\$ 13,000.00	\$ 3,437.70	\$ -	\$ -
55	\$ -	\$ -	\$ 304,000.00	\$ 59,817.22
60	\$ 161,000.00	\$ 27,327.03	\$ -	\$ -
70	\$ -	\$ -	\$ 161,000.00	\$ 20,333.87
75	\$ 101,000.00	\$ 11,003.47	\$ -	\$ -
Total Present Value		\$14,365,969.12		\$ 8,649,888.22
Residual Value		-\$ 832.80		-\$ 194.59
Net Present Value:		\$14,365,136.32		\$ 8,649,693.64

Input 1 - GENERAL

Name of Structure: **Old Railway Rideau River Pedestrian Bridge**
 Site Number: **SN018600** (start with ')
 Number of Options Considered: **2** (max. 4)
 Discount Rate: **0.05** (0.06 recommended in MTO Financial Analysis Manual)
 Number of Rows to be entered: (not used for level 1 and 2)
 Time period: **75** (normally 50 years)
 Model Description: **Level 2 Life Cycle Cost Analysis**

Input 2 - COST ESTIMATE FOR EACH TREATMENT

Item Description	Rehabilitation Major Rehabilitation	Replacement Structure Replacement on New Alignment	Treatment 1 Replace Joint Seals (Abutments)	Treatment 2 Mill & Pave and Replace Joint Seals (Abutments & Piers)	Treatment 3 Replace Joints (Abutments) and Concrete Repairs	Treatment 4 Replace Bearings, Joint Seals (Abutments) and Concrete Repairs	Treatment 5 Replace Joint Seals (Abutments) and Concrete Repairs
Design							
Construction	\$ 11,840,000.00	\$ 9,860,000.00	\$ 13,000.00	\$ 88,000.00	\$ 161,000.00	\$ 304,000.00	\$ 101,000.00
Demolition							
Right-of-Way							
Approaches							
Utilities							
Creek Diversion							
Detour							
Other							
Total	\$ 11,840,000.00	\$ 9,860,000.00	\$ 13,000.00	\$ 88,000.00	\$ 161,000.00	\$ 304,000.00	\$ 101,000.00

Input 3 - COST DATA FOR EACH OPTION

Analysis Year	Option 1 Description	Cost in Current Dollars	Option 2 Description	Cost in Current Dollars
5	Rehabilitation	\$ 11,840,000	Replacement	\$ 9,860,000
20	Treatment 2	\$ 88,000	Treatment 1	\$ 13,000
30	Replacement	\$ 9,860,000		\$ -
35		\$ -	Treatment 3	\$ 161,000
45	Treatment 1	\$ 13,000		\$ -
55		\$ -	Treatment 4	\$ 304,000
60	Treatment 3	\$ 161,000		\$ -
70		\$ -	Treatment 3	\$ 161,000
75	Treatment 5	\$ 101,000		\$ -
Totals		\$ 22,063,000		\$ 10,499,000

Input 4 - SECOND CYCLE REPLACEMENT TO DETERMINE RESIDUAL VALUE

Option	Replacement Year	Cost
1	105	
2	80	

Residual Value Calculation Table

Option	Replacement year	Cost	Residual Year	Value at end of 1st cycle	Residual value at end of 1st cycle	Residual value at year zero
1	105	\$ 13,000.00	30	\$ 3,007.91	-\$ 9,992.09	-\$ 257.31
2	80	\$ 13,000.00	5	\$ 10,185.84	-\$ 2,814.16	-\$ 72.47

Output

Year	Option 1		Option 2	
	Cost	Present Value	Cost	Present Value
5	\$ 11,840,000.00	\$ 9,276,949.81	\$ 9,860,000.00	\$ 7,725,568.00
20	\$ 88,000.00	\$ 33,166.27	\$ 13,000.00	\$ 4,899.56
30	\$ 9,860,000.00	\$ 2,281,381.64	\$ -	\$ -
35	\$ -	\$ -	\$ 161,000.00	\$ 29,187.74
45	\$ 13,000.00	\$ 1,446.85	\$ -	\$ -
55	\$ -	\$ -	\$ 304,000.00	\$ 20,771.23
60	\$ 161,000.00	\$ 8,619.22	\$ -	\$ -
70	\$ -	\$ -	\$ 161,000.00	\$ 5,291.45
75	\$ 101,000.00	\$ 2,600.90	\$ -	\$ -
Total Present Value:		\$ 11,604,164.70		\$ 7,785,717.98
Residual Value:		-\$ 257.31		-\$ 72.47
Net Present Value:		\$ 11,603,907.39		\$ 7,785,645.51

Renewal Options Analysis – Options Listing



SECTION A: GENERAL DATA	
Structure Number:	018600
Contractor ID:	313332
Asset:	4888423
Work Order:	11316581
Inventory Data:	
Structure Name:	018600, Old Railway Rideau River Ped Bridge
Year Built:	1906
Last Rehab Year:	1999
Location:	Over Rideau River, RF ConD LotG/RF ConJG Lot11
Road Name:	HIGHWAY 417
Intersections:	
Municipality:	OO
Ward:	17
Y Latitude:	5031052.656
X Longitude:	370318.277
Total Width:	4.00
Total Span Length:	159.4
Total Span Area:	637.6
Structure Type:	GIRDER
Structure Material:	STEEL
Number of Spans:	8
Orientation:	EAST_WEST
Skew Angle in degrees:	
Overall Structure Assessment Notes	
Date of Assessment (YYYY-MM-DD):	2018-06-11
Consultant:	Parsons
Other Consultant:	Gemtec
Discount Rate:	

Renewal Options Analysis – Option 1 Listing



Option's Ranking: **2** Total Cost: **\$8,165,000.00**
 Option Description: **Major Rehabilitation**

ID	Component	Year of Work	Treatment	Cost	Treatment Description
1	4888423 - 018600, Old Railway Rideau River Ped B	2023	MAJOR REHAB	\$ 8,165,000.00	Major Rehab of Structure
2					
3					
4					
5					
6					
7					
8					
9					
10					
11					
12					
13					
14					
15					
16					
17					
18					
19					
20					
21					
22					
23					
24					
25					
26					
27					
28					
29					
30					
31					
32					
33					
34					
35					
36					
37					
38					
39					
40					
41					
42					
43					
44					
45					
46					
47					
48					
49					
50					
51					
52					
53					
54					
55					
56					
57					
58					
59					
60					
61					
62					
63					
64					
65					
66					
67					
68					
69					
70					
71					
72					
73					
74					
75					
76					
77					
78					
79					
80					
81					
82					
83					
84					
85					
86					
87					
88					
89					
90					

Renewal Options Analysis – Option 2 Listing



Option's Ranking: Total Cost:
 Option Description:

ID	Component	Year of Work	Treatment	Cost	Treatment Description
1	4888423 - 018600, Old Railway Rideau River Ped B	2023	REPLACE	\$ 6,800,000.00	Replace on New Alignment
2					
3					
4					
5					
6					
7					
8					
9					
10					
11					
12					
13					
14					
15					
16					
17					
18					
19					
20					
21					
22					
23					
24					
25					
26					
27					
28					
29					
30					
31					
32					
33					
34					
35					
36					
37					
38					
39					
40					
41					
42					
43					
44					
45					
46					
47					
48					
49					
50					
51					
52					
53					
54					
55					
56					
57					
58					
59					
60					
61					
62					
63					
64					
65					
66					
67					
68					
69					
70					
71					
72					
73					
74					
75					
76					
77					
78					
79					
80					
81					
82					
83					
84					
85					
86					
87					
88					
89					
90					

APPENDIX I

Preliminary General Arrangement Drawing

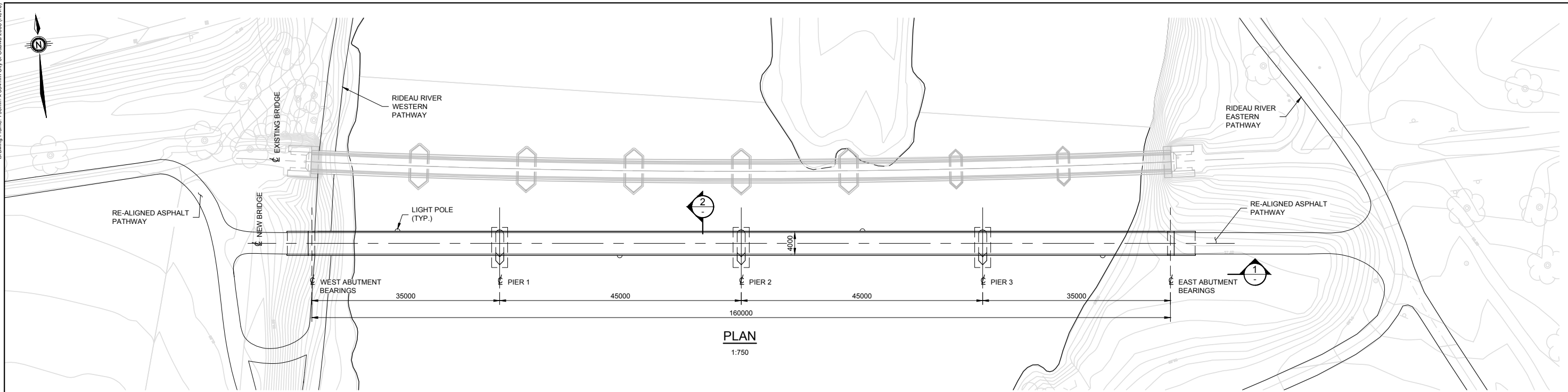

PLAN
1:750

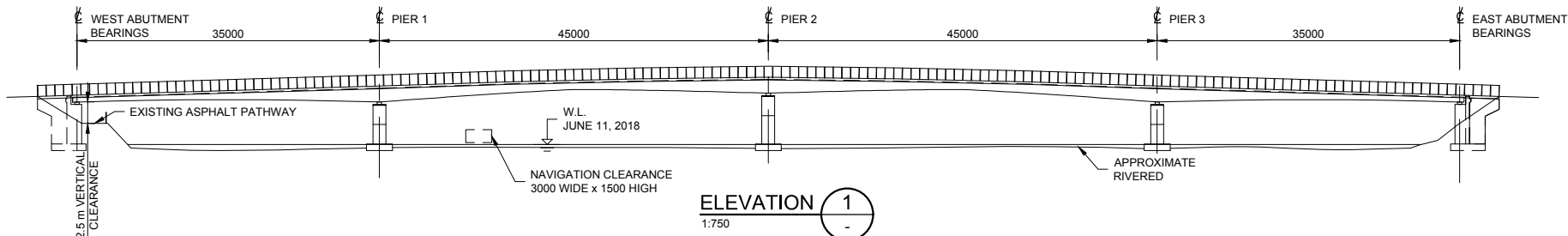

ELEVATION 1
1:750

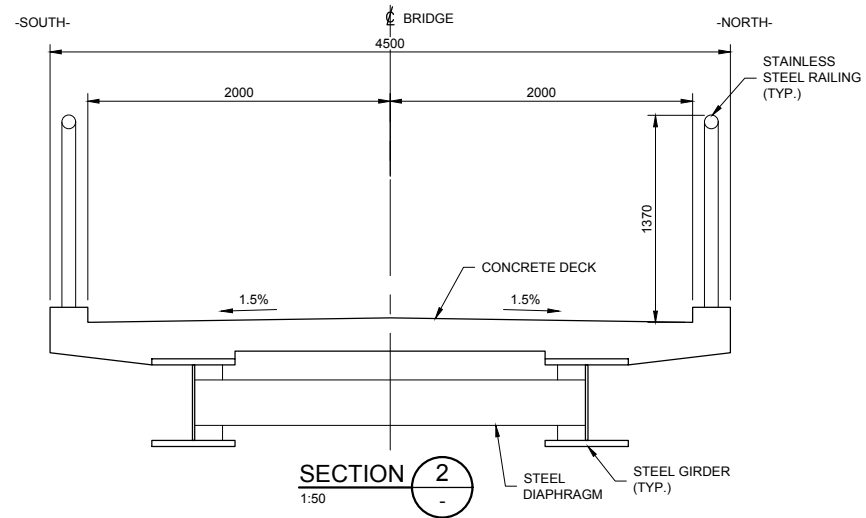

SECTION 2
1:50